

PacT Series  
**TransferPacT**

Catalog 2022  
Transfer Switching Equipment  
Source-changeover systems

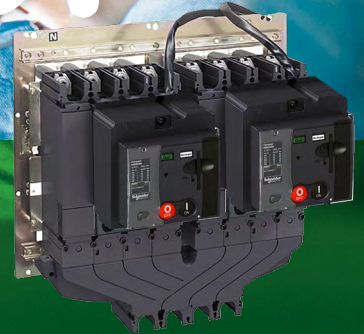



# Green Premium™

An industry leading portfolio of offers delivering sustainable value



More than 75% of our product sales offer superior transparency on the material content, regulatory information and environmental impact of our products:

- RoHS compliance
- REACH substance information
- Industry leading # of PEP's\*
- Circularity instructions

The Green Premium program stands for our commitment to deliver customer valued sustainable performance. It has been upgraded with recognized environmental claims and extended to cover all offers including Products, Services and Solutions.

#### CO<sub>2</sub> and P&L impact through... Resource Performance

Green Premium brings improved resource efficiency throughout an asset's lifecycle. This includes efficient use of energy and natural resources, along with the minimization of CO<sub>2</sub> emissions.

#### Cost of ownership optimization through... Circular Performance

We're helping our customers optimize the total cost of ownership of their assets. To do this, we provide IoT-enabled solutions, as well as upgrade, repair, retrofit, and remanufacture services.

#### Peace of mind through... Well-being Performance

Green Premium products are RoHS and REACH compliant. We're going beyond regulatory compliance with step-by-step substitution of certain materials and substances from our products.

#### Improved sales through... Differentiation

Green Premium delivers strong value propositions through third-party labels and services. By collaborating with third-party organizations we can support our customers in meeting their sustainability goals such as green building certifications.



Discover what we mean by green  
**Check your products!**

\*PEP: Product Environmental Profile (i.e. Environmental Product Declaration)



A transfer switching equipment is indispensable:

For critical applications  
in particular  
For all others  
in general



A transfer switching equipment is indispensable for applications that need a continuous supply of electric power (hospitals, airports, banks, government facilities, etc.).

But A transfer switching equipment is also suitable for all LV electrical installations exposed to:

- > **Nominal voltage loss or dip (when there is high demand for electric power)**
- > **Unpredictable power quality**



> **Frequent power cuts.**

These factors, and many others, can damage the continuity of service of your electrical installation.

For infrastructure managers, a source-changeover system gives direct economic benefits: it is possible to select your source based on power cost.

In this case, the replacement source is used as an alternative, more economical source.



- > **Managing energy efficiently**
- > **Power Cost**
- > **Safety**

# Where backup supply must be reliable: now that is everywhere.

Electricity is the fuel that feeds economic activity. Very few operations can withstand the financial impact of an electrical stoppage.

For occupant comfort, business continuity, and worker/visitor safety, dependability levels which used to apply to hospitals or airports are now becoming required in shopping malls and offices.

Additionally, utility companies make their contracts more sophisticated to deal with energy concerns: for example, by including time restrictions to total accessible power.

For these reasons, backup power sources expand across all types of buildings, and require high performance connection and management.

**Enabling you to meet these challenges, TransferPacT comes as the natural continuation of the world leading low voltage distribution system developed by Schneider Electric.**





**\$740 000**

average cost per event of  
unplanned downtime in a  
data center

Source

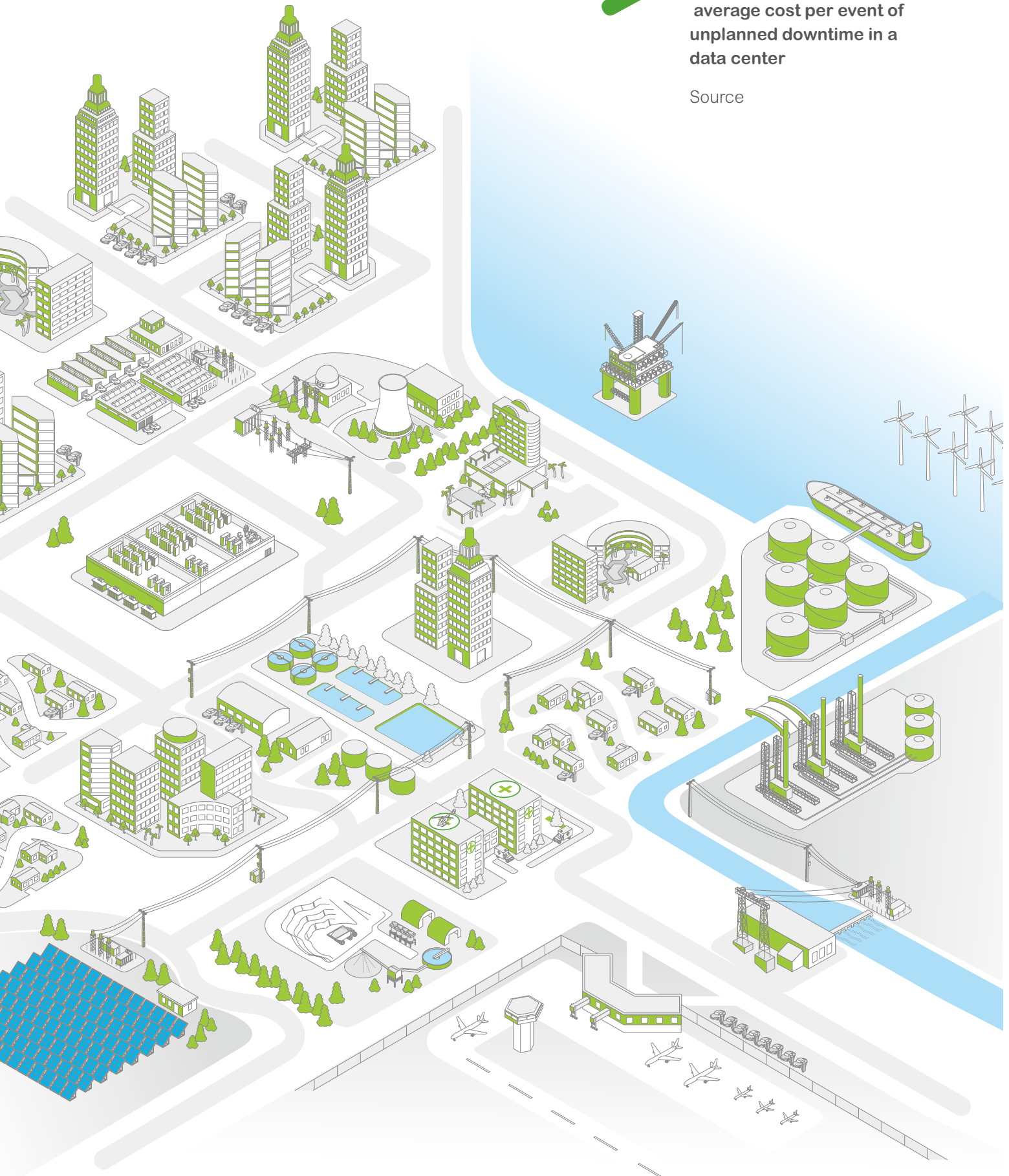

# 3 ways to switch the load to meet your needs



①

## Automatic source-changeover system (or ATSE: Automatic Transfer Switching Equipment)

**An automatic controller may be added to a remote-operated source-changeover system.** It is possible to automatically control source transfer according to programmed (dedicated controllers) or programmable (PLC) operating modes. **These solutions ensure optimum energy management.**

### System

**Derived ATSE:** 2 or 3 circuit breakers that may have different configurations, linked by an electrical interlocking system. A mechanical interlocking system protects against electrical malfunctions or incorrect manual operations, with an automatic control system (dedicated controllers or PLC).

**Non-derived ATSE:** A specific designed ATSE with a specific controller for it. A mechanical interlocking system is standard for product which protects against electrical malfunctions or incorrect manual operations.

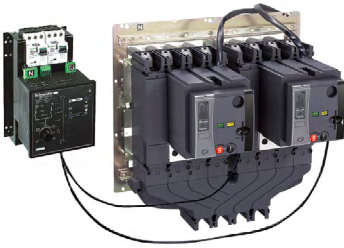

②

## Manual source-changeover system (or MTSE: Manual Transfer Switching Equipment)

**A very simple way to switch the load. It is controlled manually by an operator. The time required to switch from the 'N' source to 'R' source can vary.**

### System

2 or 3 mechanically interlocked manually-operated circuit breakers or 2 switch-disconnectors.



③

## Remote-operated source-changeover system (or RTSE: Remote Transfer Switching Equipment)

**The most commonly used system for devices with high ratings. No direct human intervention is required. Source-changeover is controlled electrically.**

### System

2 or 3 circuit breakers that may have different configurations, linked by an electrical interlocking system.

In addition, a mechanical interlocking system protects against electrical malfunctions or incorrect manual operations.



## Applications

### Commercial and service sector

(operating rooms in hospitals, safety systems for buildings, computer rooms for banks and insurance companies, lighting and emergency lighting systems in malls, etc.),  
**industry and infrastructure.**



## Applications

Buildings and infrastructure where the need for continuity of service is significant but not a priority: offices, small and medium-sized businesses..

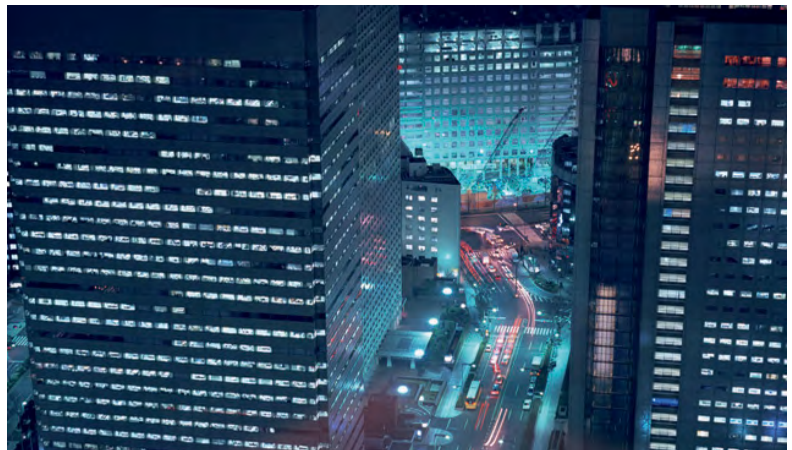

## Applications

**Industry** (assembly lines, engine rooms on ships, critical auxiliaries in thermal powerstations, etc.);

**Infrastructure** (port and railway installations, runway lighting systems, control systems on military sites, etc.).



# Whatever the system, you benefit from our expertise!



For many years Schneider Electric's source changeover system have proved their reliability everywhere around the world, in most power dependable buildings. Switching is performed by ComPacT or MasterPacT circuit breakers, the ultimate references in industrial switchgear.

## Maximized continuity of service

- > Energy availability is ensured whatever the external requirements (e.g. high power demand).
- > Maintenance and replacement of the sources (N or R) can be done with no interruption of service.

You can maintain a continuous level of service and customer satisfaction.

## Maximized safety

For LV electrical installations where safety and continuity of service are critical for people and/or equipment such as hospitals, airports, banks, malls, etc.

## Optimized energy management

- > Transfer the load to a replacement source according to external requirements.
- > Manage power sources according to power quality and power costs.
- > Perform system regulation.
- > Switch to an emergency replacement source.

You are no longer dependent on your power supply (and supplier)!

## Simplicity and reliability

- > **Simple installation** on LV switchboard.
- > **Optimized size** of the switchboard.
- > System **based on pre-tested components**.
- > Compliance with **IEC 60947-6-1**.



## Other information

### TransferPacT Automatic



> LVPED216028EN

### ComPacT NSXm - NSX



> LVPED217032EN

### ComPacT INS/INV



> LVPED213024EN

### ComPacT NS



> LVPED211021EN

### MasterPacT MTZ



> LVPED216026EN

# For maximum continuity of service...

## Incoming feeders and main LV switchboards

PB115735.eps



**Currents**  
From 630 to 6300 A.

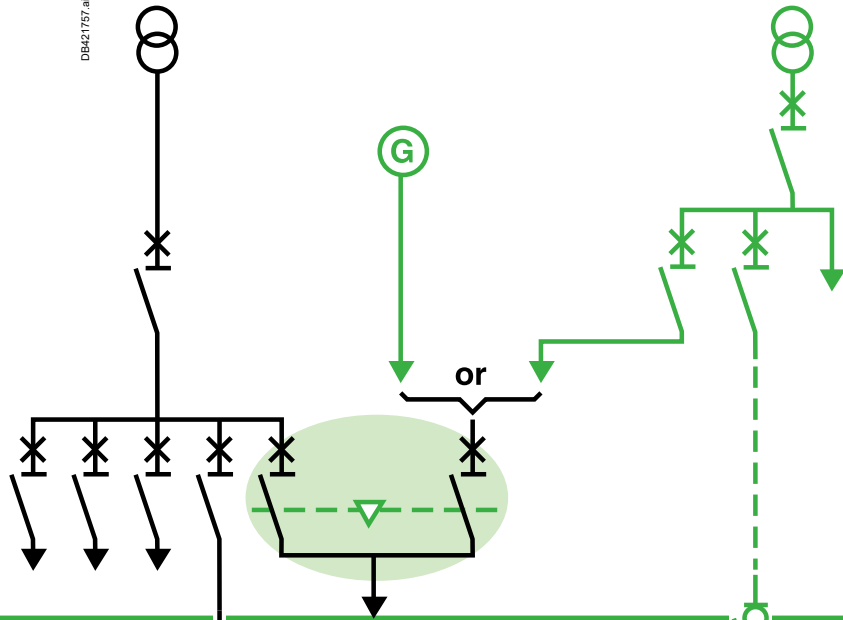

## Power distribution

PB115734.eps



**Currents**  
From 250 to 3200 A.

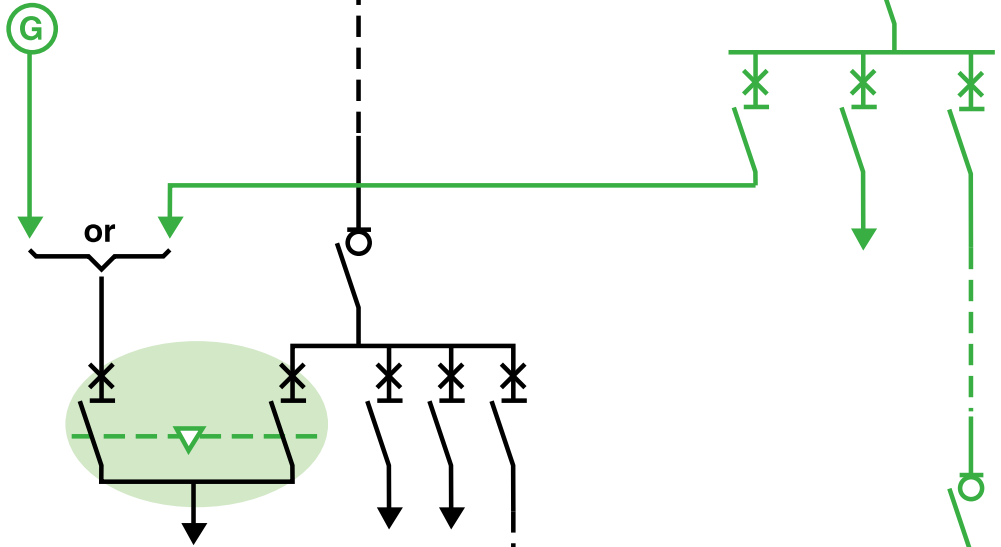

## Loads

PB50346.eps



**Currents**  
From 40 to 400 A.

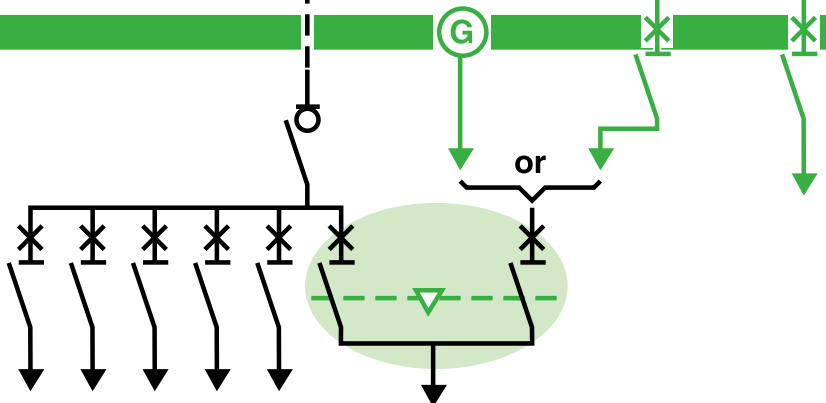

# ... in a wide range of applications

1 normal source  
1 replacement source

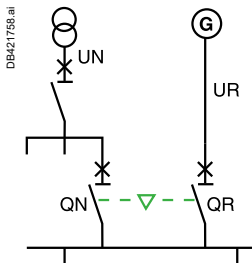

QN	QR
0	0
1	0
0	1

2 sources with coupler on busbars

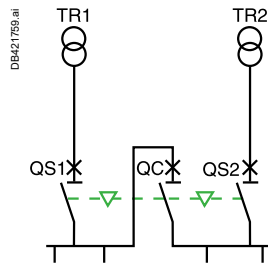

QS1	QC	QS2
0	0	0
1	0	1
1	1	0
0	1	1
1	0	0 <sup>(1)</sup>
0	0	1 <sup>(1)</sup>

<sup>(1)</sup> possible by forcing operation.

2 normal sources  
1 replacement source

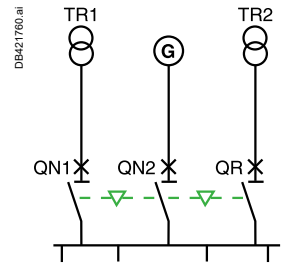

QN1	QN2	QR
0	0	0
1	1	0
0	0	1
1	0	0
0	1	0

Generator or permanent source

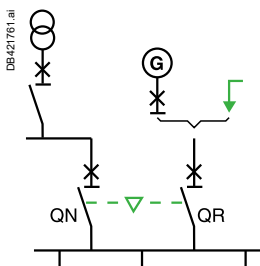

QN	QR
0	0
1	0
0	1

**Typical applications:**

- Continuous production processes
- Most distribution panels in hospitals, including operating rooms
- Computer rooms...

Generator or permanent source

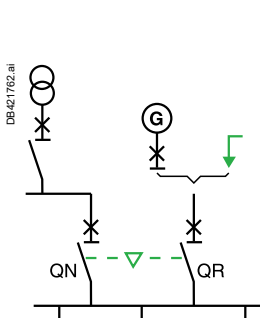

Generator or permanent source

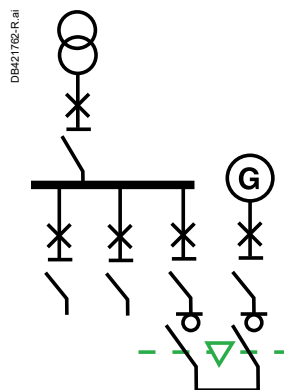
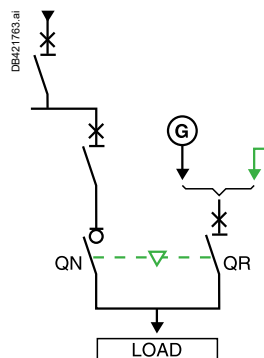

QN	QR
0	0
1	0
0	1

**Typical applications:**

- Large electrical installations (e.g. airports)
- Refrigeration units
- Special electricity tariffs
- Safety system such as fire alarm, fire pump, safety lifting stations



# General Contents

## General Contents

### Transfer**PacT**

#### Transfer**PacT** Automatic and Active Automatic

(Automatic Transfer Switching Equipment)

A

#### Transfer**PacT** FXM

(MTSE/complete source changeover assembly)

B

#### Transfer**PacT**: Com**PacT** and Master**PacT** based

(Manual, Remote and Automatic TSE/source changeover systems)

C



## TransferPacT Automatic and Active Automatic

TransferPacT Class PC .....	A-2
General features .....	A-4
Electrical and mechanical accessories .....	A-8
Controller general features.....	A-15
Control Mode and Transfer Logic.....	A-18
Automatic Transfer Switching Equipment.....	A-41
Coding Principle.....	A-54
References of TransferPacT Active Automatic and Automatic 32-160 A .....	A-55
Circuit breaker/Transfer Switching Equipment coordination .....	A-57
Fuses/Transfer Switching Equipment coordination .....	A-61

A

# TransferPacT Class PC

## A

### ATSE: Automatic Transfer Switching Equipment

(Non-derived ATSE, PC Type)

**ATSE**

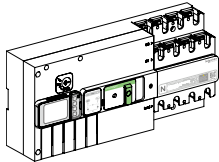

**Function Modules**

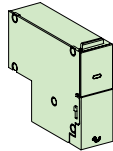

**Indication Auxiliaires**

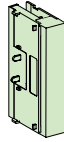

**External HMI**

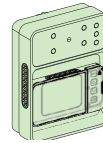

**Cable**



### Definition of Class PC

Transfer switch equipment based on mechanical switching devices, that do not need electrical power to hold the main contacts open or closed and capable of making, carrying, and breaking currents under normal circuit conditions including operating overload conditions, and making and withstanding short-circuit currents.

### Definition of ATSE(Automatic Transfer Switching Equipment)

Self-acting transfer switching equipment, including all necessary sensing inputs, monitoring, and control logic for transferring operations

TransferPacT automatic transfer switching equipment is a Class PC ATSE specially designed in accordance with IEC 60947-6-1 requirements for power transfer. It has great withstand capabilities to short circuits and reliable making, carrying and breaking capabilities. Thus keeping reliable connectivity of circuits.

It is an all in one, Non-derived ATSE.

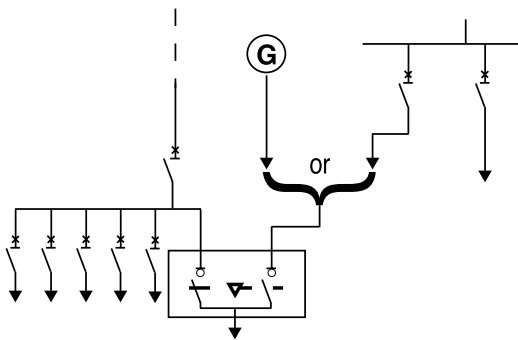



# TransferPacT Class PC

TransferPacT is a high speed, comPacT, modular design intelligent automatic transfer switch that provide maximum scalability and robust performance. It is a PC class ATSE designed according to IEC 60947-6-1, available through 32A to 160A, 2,3,4 pole with rated operating voltage through 220V to 440V.

A



## Power availability

### Maximized uptime:

Innovative technology ensuring transfer in less than 500 ms.

### Vast application:

Utilization category AC-33B without derating, fits the most complicated load types.

### Reliable under extreme condition:

Short circuit capabilities including short time withstand current for your power continuity.

### Robust design – Extreme Environment Proof:

- Best-in-class electromagnetic protection, Exceeding industry standards on class B.
- Designed to perform in harsh environments with operating temperature -25...70 °C
- Successfully passed testing in compliance with IEC 60068-2-6 and IEC 60068-2-27.



## Efficiency

### Easy installation:

- Built-in DPS and sensing wire, 30% commissioning time saving.
- Multiple installation adapted. E.g. DIN rail.

### Enhanced scalability:

- 10 function modules plug and play, non-disruption upgrading.



## Connectivity

### Natively connected – Integrated in EcoStruxure™ Power

- 24/7 Precise power monitoring on voltage, frequency, voltage unbalance, phase rotation.
- Predictive maintenance with hands-on approach and cloud-based monitoring software that synthesizes and analyzes performance and alert data into proactive recommendations. TransferPacT enables wherever-you-go visibility.



## Cyber security

Designed according to cyber security standard IEC 62443 at the level of SL1.



## Sustainability

### Green premium ecolabel.

- Green Package for full product range.
- Saving trees - Scan QR code for full version for technical documents.

# General features

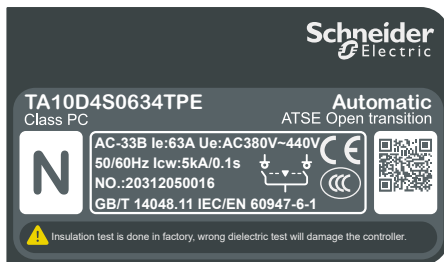
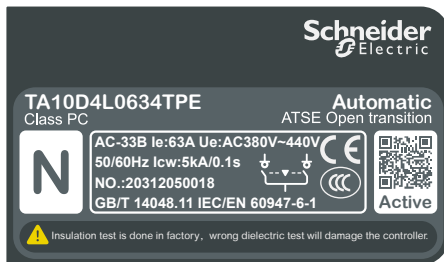

## Codes and standard

- IEC 60947-1 General rules
- IEC 60947-6-1 Transfer switching equipment
- GB 14048.1 General rules
- GB/T 14048.11 Transfer switching equipment

## Certifications and declarations

- CB certification
- CE certification
- CCC certification
- UKCA declaration
- EAC declaration

## Environmental conditions

- TransferPacT ATSE can operate in an ambient temperature of  $-25\text{ °C} \sim +70\text{ °C}$
- The altitude of the installation site shall not exceed 2000 m
- When the highest temperature is  $+55\text{ °C}$ , the relative humidity in air shall not exceed 95%
- Storage temperature:  $-35\text{ °C} \sim +85\text{ °C}$

## Vibration and Shock

- Tests are carried out in compliance with IEC 60068-2-6 and IEC 60068-2-27

## Electromagnetic compatibility (EMC)

- EMC Class A
- EMI Class B
- Electrostatic discharge Level 4
- Radio-frequency electromagnetic field Level 3
- Fast transient bursts Level 4
- Surges Level 4
- Harmonic wave Level 3
- Voltage dips and short-time interruptions Level 3

## Degree of Pollution

- Pollution degree 3 as defined by IEC standard 60947

# General features

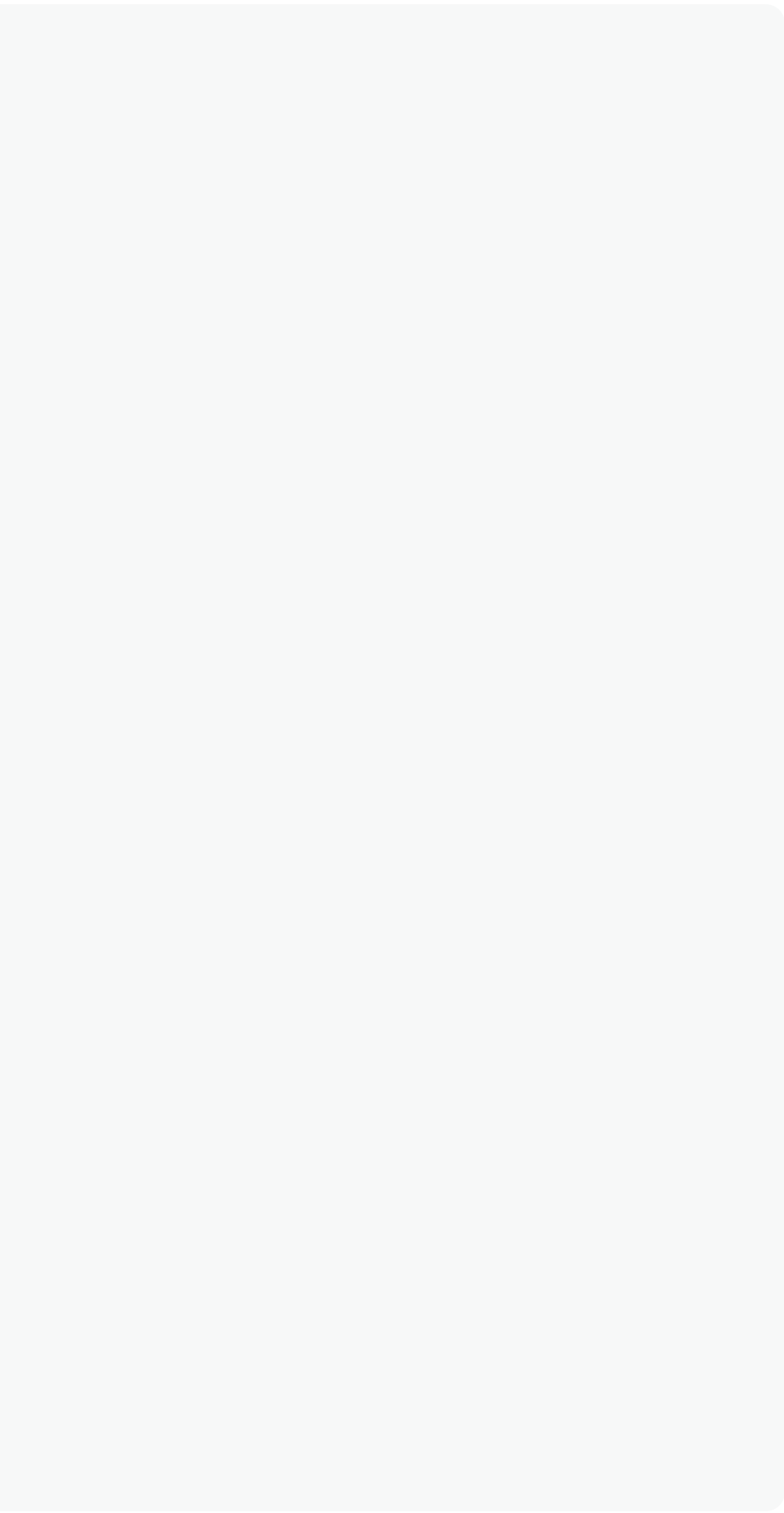

# General features



TransferPacT Active Automatic



TransferPacT Automatic

**TransferPacT Automatic /TransferPacT Active Automatic**

Frame		
Conventional Thermal Current	I <sub>th</sub>	at 60 °C
Rated operating current (A)	I <sub>e</sub>	AC-33B
		AC-32B
Number of poles		
Operating positions		
Control types		

**Electrical characteristics as defined by IEC 60947-1 / 60947-6-1 and EN 60947-1 / 60947-6-1**

Rated insulation voltage (V)	U <sub>i</sub>	
Rated impulse withstand voltage (kV)	U <sub>imp</sub>	
Rated operating voltage (V)	U <sub>e</sub>	AC50/60 Hz
Rated operating frequency (Hz)	F	
Rated short-time withstand current (kA/60 ms)	I <sub>cw</sub>	
Rated short-circuit making capacity (400 V, 50 Hz)	I <sub>cm</sub>	switch alone
		with upstream circuit breaker
Rated duties		Uninterrupted duty
Contact Transfer Time* (I -> II or II -> I)		
I -> II or II -> I transfer time*, after power loss		
Mechanical durability		
Suitability for Isolation		

**Installation and connection- Fixed, front connection**

Installation		
Wiring		
<b>Switch Accessories</b>		
Position feedback(Auxiliary contact)		
Terminal cover		
Rail buckle		
Terminal Shield		
Load extension bars		
Interphase barrier		
Tightening torque for electrical connections (Nm)		
Degree of pollution		
Upstream protection	Refer to Complementary technical information	
Dimensions and weights		

Overall dimensions	2pole	
H x W x D (mm)	3pole	
	4pole	
	2pole	
Approximate weight (kg)	3pole	
	4pole	

Note:  
 ■ Standard □ Optional  
 (1) default 230 V/400 V  
 \* : Transfer times are at rated voltage, excluding time delays when applicable  
 \*\*: suitable for normal and upside down installation  
 For the upstream protection coordination with transfer switching equipment, refer to coordination tables in page A55-A59 or complementary technical guide

# General features



	TA10D	TA16D
	100	160
	100	160
	32,40,50,63	80,100,125,160
	80,100	
	2/3/4	3/4
	3	3
	Active Automatic HMI/ Automatic HMI	Active Automatic HMI/ Automatic HMI

	TA10D	TA16D
	800	800
	6	8
	2P:220/230/240/250 V(1) 3P,4P:380/400/415/440 V(1)	3P,4P:380/400/415/440 V(1)
	50/60 Hz	50/60 Hz
	5kA/0.1 s	10kA/0.1 s
	15 kA	20 kA
	75 kA	154 kA
	■	■
	≤ 200 ms	≤ 200 ms
	≤ 500 ms	≤ 500 ms
	8,000	10,000

	TA10D	TA16D
	Rail/base plate**	Rail/base plate**
	busbar /Cable	Busbar/crimp lug

	TA10D	TA16D
	□	□
	■	■
	■	■
	□	□
	□	□
	-	□
	3.5±0.3 N•m 30.97±2.65 lb-in	8±0.8 N•m 70.8±7.08 lb-in
	3	3

	155 x 310 x 94	
	155 x 310 x 94	164 x 351 x 95
	155 x 310 x 94	164 x 351 x 95
	3.4	-
	3.4	5.6
	3.4	5.6

# Electrical and mechanical accessories

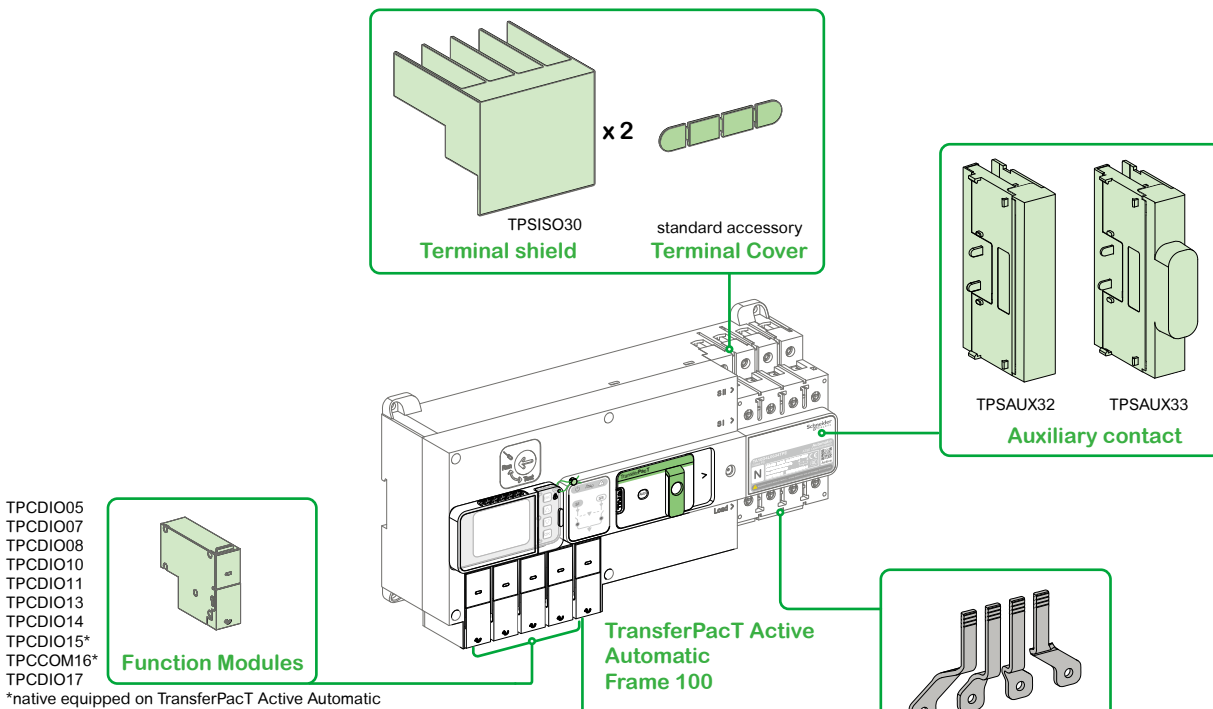
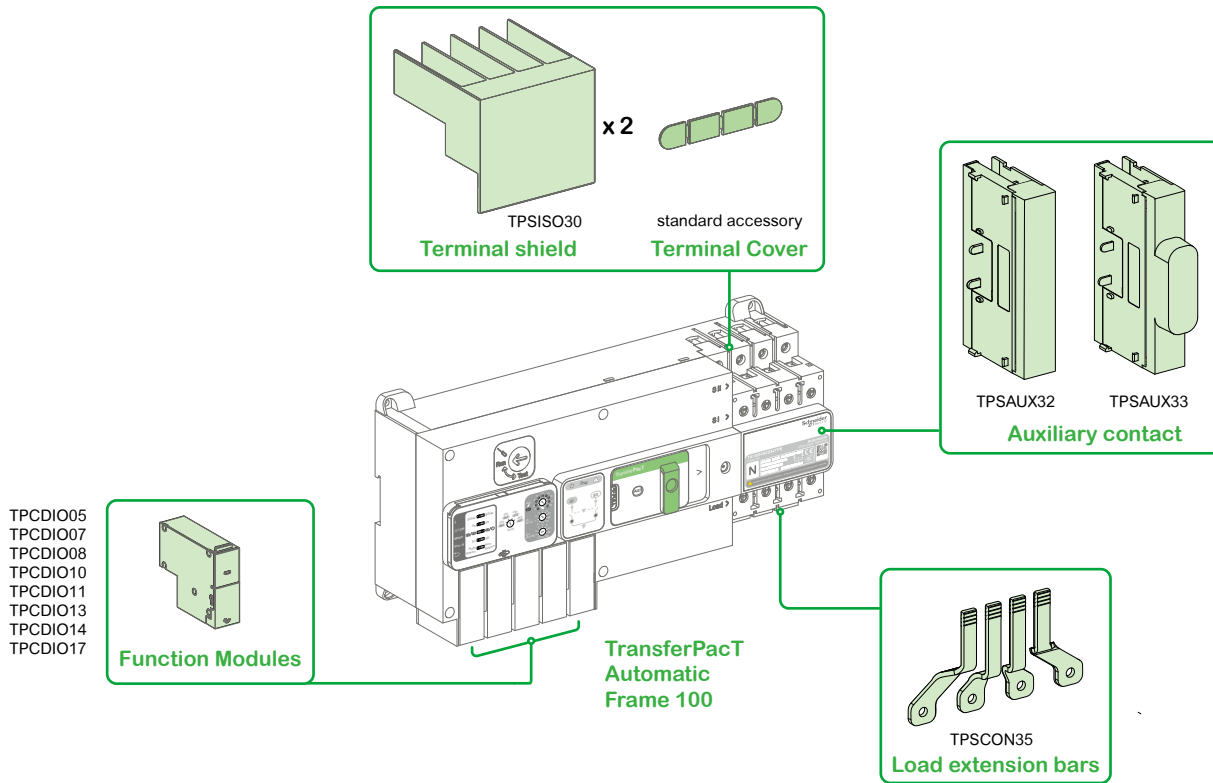

\*native equipped on TransferPacT Active Automatic

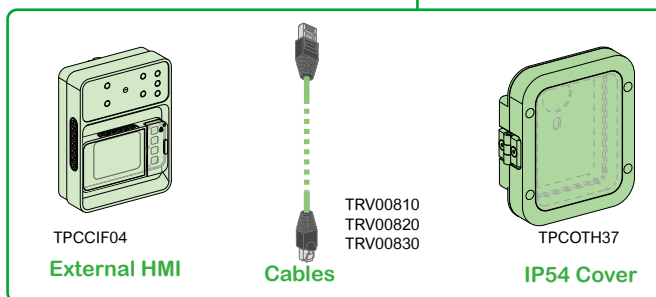

# Electrical and mechanical accessories

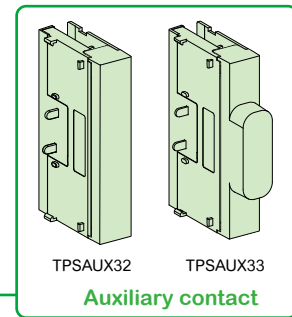
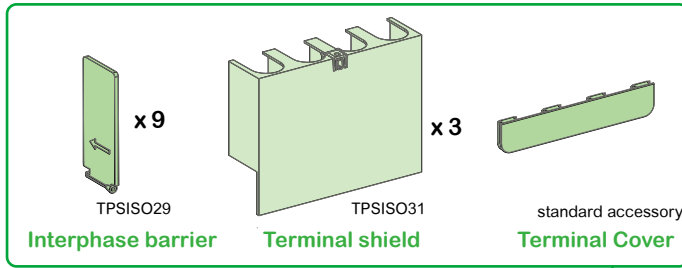

- TPCDIO05
- TPCDIO07
- TPCDIO08
- TPCDIO10
- TPCDIO11
- TPCDIO13
- TPCDIO14
- TPCDIO17

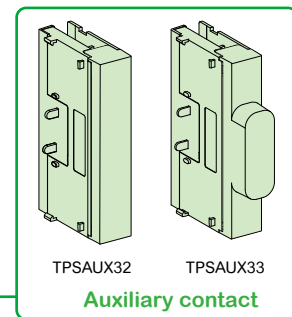
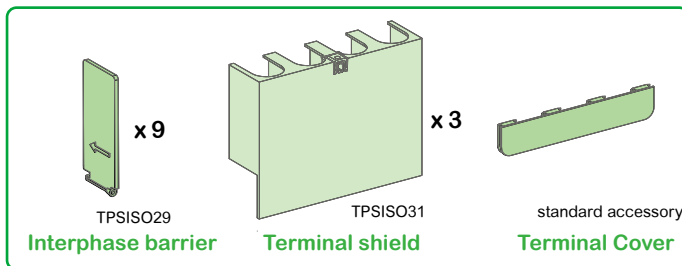
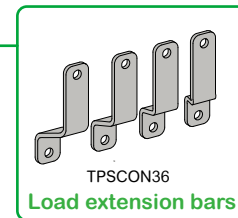
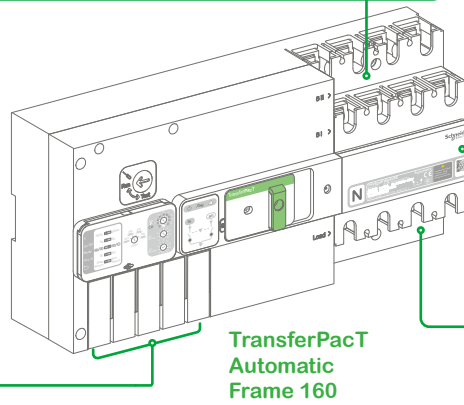
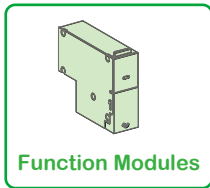

- TPCDIO05
- TPCDIO07
- TPCDIO08
- TPCDIO10
- TPCDIO11
- TPCDIO13
- TPCDIO14
- TPCDIO15\*
- TPCCOM16\*
- TPCDIO17

\*native equipped on TransferPacT Active Automatic

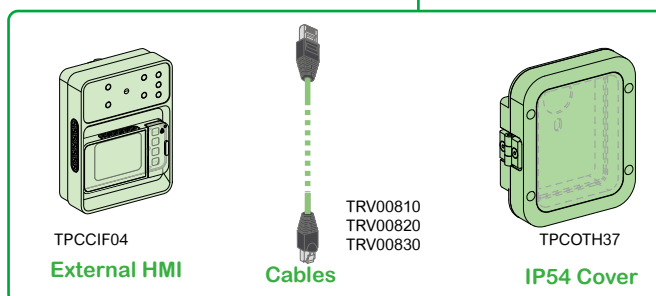
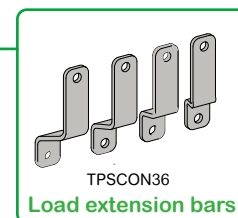
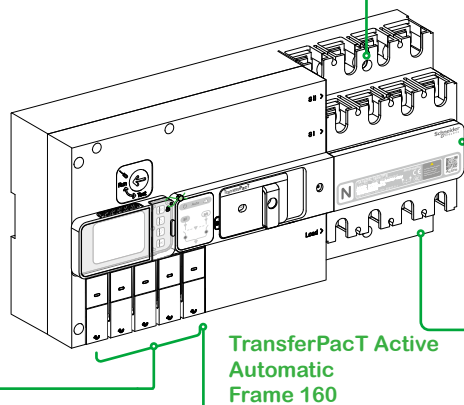
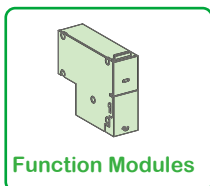

# Electrical and mechanical accessories

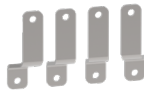
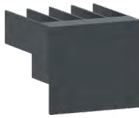

## Auxiliary contact module

- TPSAUX32: Provide the open and closed status indication for both source I and source II.
- TPSAUX33: Provide the open and closed status indication for OFF position.

## Terminal Shield

Optional accessory, Provide terminal protection on the cable incoming and output.

- TPSISO30: Terminal Shield for frame 100 (32-100 A) (set of 2)
- TPSISO31: Terminal Shield for frame 160 (80-160 A) (set of 3)

## Interphase barrier

Optional accessory, Provide protection for the cable incoming and output, effectively avoiding short circuits between phases.

- TPSISO29: Interphase barrier for frame 160 (80-160 A) (set of 9)

## Load extension bars

Optional accessory, Provide simple connection for the load side terminals.

- TPSCON35: extension for frame 100 (32-100 A) (set of 4)
- TPSCON36: extension for frame 160 (80-160 A) (set of 4)

## External HMI

- Door mounted HMI provide exact same function as TransferPacT active automatic HMI Including status display, settings, event log, control transfer switch. It consists of an install base and LCD display. TPCCIF04

## IP54 Cover

- Optional accessory, Protective cover for external HMI for outdoor installations. TPCOTH37.

## HMI Cable

Used to connect the TSE and external HMI. 2\*RJ45 port.

- TRV00810: cable length is 1m
- TRV00820: cable length is 2m
- TRV00830: cable length is 3m



# Electrical and mechanical accessories

A

## Load shedding and availability warning

### Function:

#### Load shedding

- The emergency power (Genset) sometimes may not afford all loads. A signal from controller will shed some non-critical loads
- Load shedding will send the signal after enabling this function

#### Availability warning output

- When transfer switch is not in auto or power lost on two sources, a dry contact will output the signal
- After back to Auto status or power recovery, the signal will be stopped

Compatibility: Active Automatic and Automatic

Rating: 250 VAC, 5 A or 30 VDC, 5 A

Digital output



## Transfer inhibit and Remote testing

### Function:

#### Transfer inhibit

- Transfer Inhibit when there is power interruption because of short circuit
- This function can be used to lock the controller by customized signals
- This function can be used for cooperation with different ATSE
- Remove transfer inhibit signal to Exit this mode

#### Remote testing

- Remote testing is an input signal to start test procedure.
- The remote test can only be started at Auto mode
- For Active Automatic HMI, on load, off load test and time duration can be selected.
- For Automatic HMI, on load test is unlimited.

Compatibility: Active Automatic and Automatic

Dry Contact

Digital input



## Voluntary Remote control

### Function:

#### Voluntary transfer to N or A

- Voluntary transfer is an active input. It can transfer the ATSE to Normal or Alternate source according to requirements (such as energy saving)
- Voluntary transfer will still keep the power continuity as much as possible. The function will be bypassed if target source loses the power. For example, after voluntary to A while A source failed, ATSE will transfer back to N if N is available
- Exit voluntary mode after signal disappeared

#### Force to Off

- An emergency stop order to transfer ATSE to off position. All the other transfer mode will be canceled except handle control
- Exit Force after signal disappeared

Compatibility: Active Automatic and Automatic

Dry Contact

Digital input



# Electrical and mechanical accessories



## Fire protection

**Function:**

The fire protection signal can transfer ATSE to off position when there is fire emergency.

- Fire protection with input of DC24 V pulse signal. Input Voltage: 24 VDC (-20% ~ +20%), Maximum Input Current: 10 mA
- Fire protection with input of DC24 V Constant signal. Input Voltage: 24 VDC (-20% ~ +20%), Maximum Input Current: 10mA
- Fire protection with input of AC230 V Constant. Input Voltage: 230 VAC (-20% ~ +20%), 50 Hz/60 Hz Maximum Input Current: 10 mA
- Fire protection with 1 input, dry contact

Compatibility: Active Automatic and Automatic  
Digital input



## BUS Extension and 24 VDC Auxiliary Supply

**Function:**

**BUS extension**

- Can be used to connect external HMI

**DC 24V Auxiliary Supply**

- External power for controller when both source failure
- External power to keep power for Modbus communication when both source failure

Compatibility: Active Automatic  
Rating: Input Voltage: 24 VDC (-20% ~ +20%), Maximum Input Current: 1 A



## Modbus RTU (Serial Port)

**Function:**

**Modbus**

- Can be used to connect with other system
- Require External 24 V or at least one main source to keep communication
- With Protocol Modbus RTU communication

Compatibility: Active Automatic



## Genset Start and Alarm

**Function:**

**Genset start output**

- When utility source is lost, a dry contact will start Genset. No matter with or without external 24 V, a time delay (T7) before genset start can be set
- When Utility source has recovered, and ATSE has transferred back to Utility, Genset signal will remain until end of Genset cooldown timer

**Alarm**

- When there is critical alarm, a dry contact will output the signal
- Restart controller (open and close dielectric door) to shut down the Alarm

Compatibility: Active Automatic and Automatic

Rating: 250 VAC, 5 A or 30 VDC, 5 A

Digital output

**Note:** The alarm signal is irrelevant to generator start or stop. It is relevant to transfer errors and phase rotations errors, for more detail, refer to DOCA0214EN-00

# Controller general features

TransferPacT provide advanced microprocessor controller with two options: Active automatic HMI (LCD display and keypad) and automatic HMI (Rotary and DIP switch). It is a robust and reliable controller which offers all of the voltage, frequency, control, timing and diagnostic functions required for wide range of power applications. Automatic HMI is easy install and use, while active automatic HMI contains every function needed with 8 control modes.

## There are two key breakthroughs for TransferPacT controller:

- Active automatic HMI and automatic HMI can be swapped, that means an easy way to upgrade your controller, or replace it for maintenance or renewal.
- 10 types of function modules can be installed on TransferPacT controller, at any time, which provide maximum scalability and a reduced Total Cost of Ownership, since you can add a function as demand grows.

Controller type		Active Automatic with LCD display	Automatic with setting by rotary switch
Installation		Embedded controller	Embedded controller
<b>Controller Functional Characteristics</b>			
2P		230 V: can be set at 220 V/240 V/250 V	230 V: can be set at 220 V/240 V/250 V
3P/4P		400 V: Can be set at 380 V/415 V/440 V	400 V: Can be set at 380 V/415 V/440 V
Rated operating frequency (Hz)		50/60	50/60
Rated insulation voltage (V)		500	500
Impulse withstand voltage (KV)		6 kV	6 kV
Operating temperature		-25 °C to +70 °C	-25 °C to +70 °C
Operating altitude		≤2000 m	≤2000 m
Protection degree		IP20	IP20
Pollution degree		3	3
Accuracy (for power deviation)	Voltage	1%	1%
	Frequency	0.1%	0.1%
Electrostatic discharge		Level 4	Level 4*
Radio-frequency electromagnetic field		Level 3	Level 3
Fast transient bursts		Level 4	Level 4
Surges		Level 4	Level 4
Harmonic wave		Class 3	Class 3
Voltage dips and short-time interruptions		Level 3	Level 3
Vibration		IEC 60068-2-6	IEC 60068-2-6
Shock		IEC 60068-2-27	IEC 60068-2-27
<b>Display of Controller</b>			
Display mode		LCD + LED + Indicator	Rotary switch + DIP switch + LED + Indicator
Single line diagram		■	■
Language		English/Chinese/French/Russian/Spanish/Italian/German/Portuguese	Not Applicable
Power status		■	■
Position for contact (electrical indication)		■	■
Set value		Button	Rotary switch + DIP switch
<b>Controll Mode</b>			
Auto	Auto return	■	■
	Non return	■	■
Non-Auto	Handle	■	■
	Force	□	□
	Fire	□	□
	Inhibit	□	□
	Local	■	-
	Voluntary	□	□
	Test	■	□

Note: ■ Standard □ Optional  
\* plastic cover need to close

# Electrical and mechanical accessories

Controller type		Active Automatic with LCD display	Automatic with setting by rotary switch
<b>Auto Control</b>			
Sampling		Three Phase for both Normal and Alternate	Three Phase for both Normal and Alternate
Voltage loss		< 36 V	< 36 V
Under voltage	Set value	70% to 95%	4%,6%, 8%, 10%, 12%, 14%, 16%, 18%, 20%
Over voltage	Set value	105% to 135%	4%, 6%, 8%, 10%, 12%, 14%, 16%, 18%, 20%
Under frequency	Set value	80% to 98%	2%, 3%, 4%, 5%, 6%, 7%, 8%, 9%, 10%
Over frequency	Set value	101% to 120%	2%, 3%, 4%, 5%, 6%, 7%, 8%, 9%, 10%
Unbalance of three phase voltage		2% to 30%	-
Phase rotation		Yes	-
<b>Time Delay</b>			
Transfer delay		0-30 minutes	U-U:0, 1, 2, 3, 5, 10, 20, 30, 60 s. U-G:5 s
Retransfer delay		0-60 minutes	0, 1, 2, 3, 5, 10, 20, 30, 60 min
Center off delay		0-30 s	0 or 5 s
Genset start delay		0-120 s	0, 1, 2, 3, 5, 10, 20, 30, 60 s
Genset cooldown delay		0-60 minutes	-
Loadshedding delay		0-15 s	-
Genset ready alarm delay		15-300 s	300 s
Test delay:on load		1-1800 s	
Test delay:off load		1-1800 s	
<b>Other Functions</b>			
Calendar time		■	-
Position feedback (mechanical)		□	□
Event log		■	-
Source priority		■	■
Communication		Modbus RTU	-
Transfer Inhibit		□	□
Password protection		■	-
Gen start-stop		□	□
Test		■	□
Load shedding		□	□
Fire protection		□	□
Failure lock		■	■
Alarm Indication		■	■
External power supply port (auxiliary supply)		■	-
Wrong connection of neutral alarm		■	-

Note: ■ Standard □ Optional

# Controller general features



## Active Automatic HMI (With LCD Display) Description

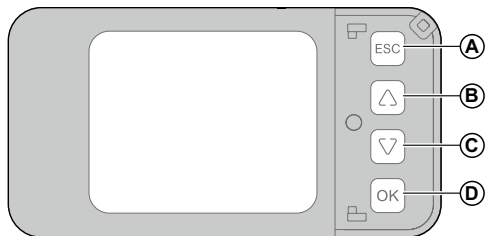

Label	Description
A	Navigation button to return to previous page
B	Navigation button of rolling up
C	Navigation button of rolling down
D	OK button to confirm any status

## Automatic HMI (With Rotary Switch) Description

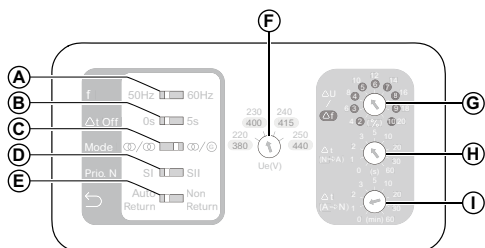

Label	Description
A	Rated frequency
B	Time delay for off position
C	"Type of source = Utility/Utility = Utility/Genset"
D	Source priority
E	Transition mode for return to normal position
F	Nominal voltage
G	Voltage and frequency thresholds setting
H	Transfer time delay in seconds from normal source to alternate source
I	Transfer time delay in minutes from alternate source to normal source

# Controller general features

## Single Line Diagram Description

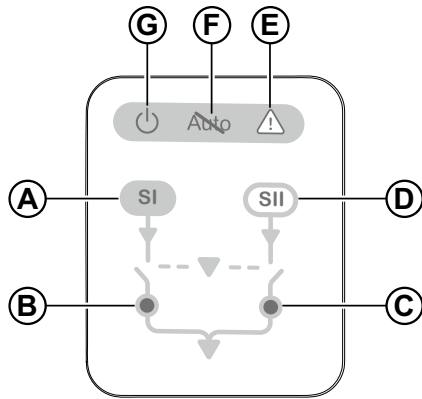

Label	Description
A	Source I power status indicator
B	Contact position of source I
C	Contact position of source II
D	Source II power status indicator
E	Alarm indicator
F	"Not in Auto" status indicator
G	Power ON indicator

# Controller general features

## Single Line Diagram LEDs

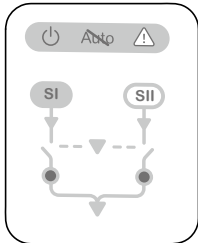

LED indication	Status	Description
	-----	No energy, ATSE power off
		ATSE updating in process or in Test mode in progress
		ATSE is running in normal operation, ready to transfer
	-----	The ATSE is running in Auto mode
		ATSE is "Not in Automatic" mode, and will not automatically transfer in case of source failure.
	-----	No alarm
		Alarm is active
SI	-----	No Source I
		Source I out of range
		Source I present and in the range
	SII	-----
		Source II out of range
		Source II present and in the range
		-----
		Time delay is running for transferring
		Source II is opened (Not connected)
	-----	Source II is opened (Not connected)
		Time delay is running for transferring
		Source II is closed (Connected)

NOTE: The LED indicator on the equipment and the external HMI is for reference. In the event of a contradiction between the LED and the mechanical indication, the latter prevail.

# Control Mode and Transfer Logic

## Transfer Switching Equipment 32–160 A

### Control Mode

#### Over view

The control mode is used to operate TSE in different applications. The TransferPacT Active automatic contains every function needed with eight control modes:

- Auto mode
- Test mode
- Voluntary transfer mode
- Local control mode
- Transfer inhibit mode
- Fire protection mode
- Force to off mode
- Handle transfer mode

The TransferPacT Automatic contains below control modes:

- Auto mode
- Test mode
- Voluntary transfer mode
- Transfer inhibit mode
- Fire protection mode
- Force to off mode
- Handle transfer mode

### Priority of Control Mode

Type of mode	Handle	Force	Fire	Inhibit	Local	Voluntary	Test	Auto
Handle Transfer mode	-							
Force to OFF mode	x	-						
Fire Protection mode	x	x	-					
Transfer Inhibit mode	x	x	x	-				
Local Control mode	x	x	x	x	-			
Voluntary Transfer mode	x	x	x	x	x	-		
Test mode	x	x	x	x	x	x	-	
Auto mode	x	x	x	x	x	x	x	-

“-“ = No caution  
 “|” = Interrupt  
 “X” = Ignore



# Control Mode and Transfer Logic

## Transfer Switching Equipment 32–160 A

### Auto Mode



ATSE works on auto control mode normally. The controller monitors the real time values of both the sources. When there is source contingency, the transfer action will be energized to keep the power continuity for critical source.

Auto mode supports U-G or U-U applications.

NOTE: Auto transfer will not be active, if transfer action damages driving system (for example, both are out of range, TSE refuses to transfer).

There are two types of auto control mode:

- Auto-return
- Non-return

Naming	Condition for stay on A situation return	
power source definition	N available	N available
	A available	A unavailable
Auto-return	Switch to N	Switch to N
Non-return	Stay at A	Switch to N

### Auto return

The Auto return has two modes as below:

- When the voltage on the N source exceeds the threshold (overvoltage, undervoltage, over frequency, under frequency) or does not exist, the ATSE will be transferred to the A source.
- When the voltage on the N source is within the threshold range, the ATSE will be transferred to N source.

The process of transfer can be controlled by time delay.

### Transfer Process for Auto return U-U Application

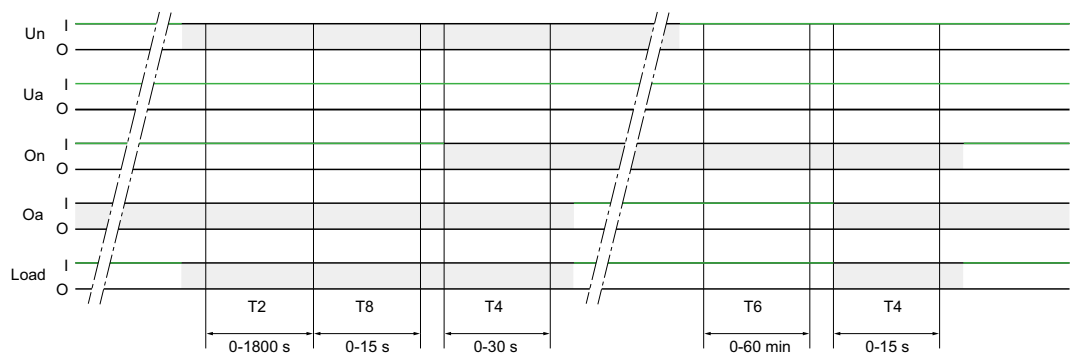

Symbols	Description
Un	Source I
Ua	Source II
On	Contact close at N source
Oa	Contact close at A source
Load	status
T2	Transfer delay
T8	Loadshed Delay
T4	Center-off Delay

# Control Mode and Transfer Logic

## Transfer Switching Equipment 32–160 A

Symbols	Description
T6	Re-Transfer Delay

**Key**  
 O: OFF (circuit open)  
 I: ON (circuit closed)  
 [Grey Box] : no Power

### Transfer Logic for Auto return U-U Application

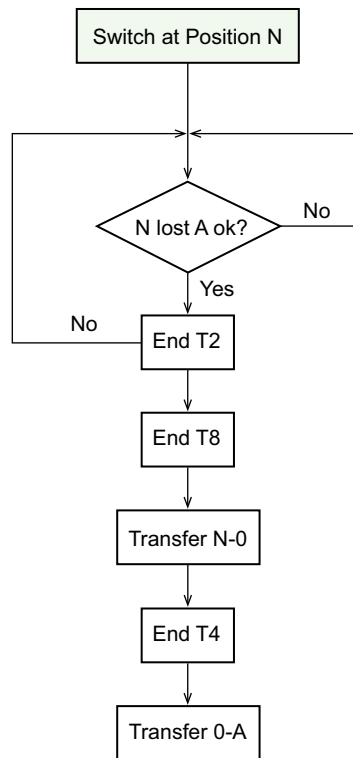

### Transfer Logic

\* T2 will reset if N becomes unavailable or A becomes unavailable

# Control Mode and Transfer Logic Transfer Switching Equipment 32–160 A

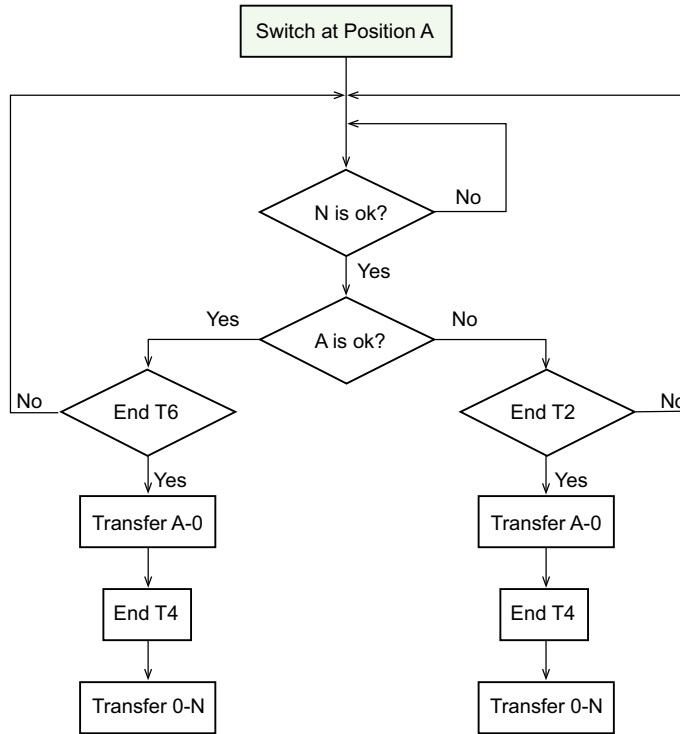

### Retransfer Logic

- T2 will reset if N becomes unavailable
- T6 will reset if N becomes unavailable
- During T6, if A is not available it will keep to count T6 if the rest time of T6 is shorter than T2. Otherwise it goes to T2

Retransfer principles: when source A ok, retransfer goes to T6, when source A not ok and source A is utility, retransfer goes to T2. If source A is Genset and not ok, retransfer delay is 0.

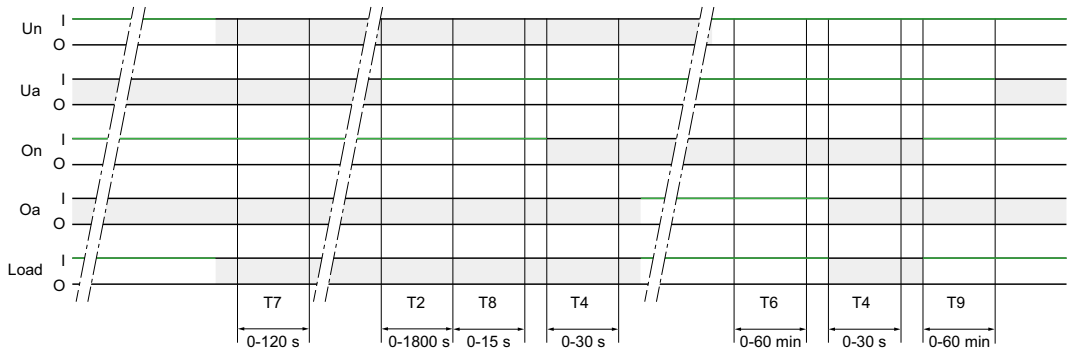

Symbols	Description
Un	Source I
Ua	Source II
On	Contact close at N source
Oa	Contact close at A source
Load	status
T7	Genset Start Delay
T2	Transfer delay
T8	Loadshed Delay
T4	Center-off Delay
T6	Re-Transfer Delay

# Control Mode and Transfer Logic

## Transfer Switching Equipment 32–160 A

Symbols	Description
<b>T9</b>	Genset Cool Delay
<b>Key</b>	
O: OFF (circuit open)	
I: ON (circuit closed)	
■ : No Power	

# Control Mode and Transfer Logic Transfer Switching Equipment 32–160 A

## Transfer Logic for U-G Application

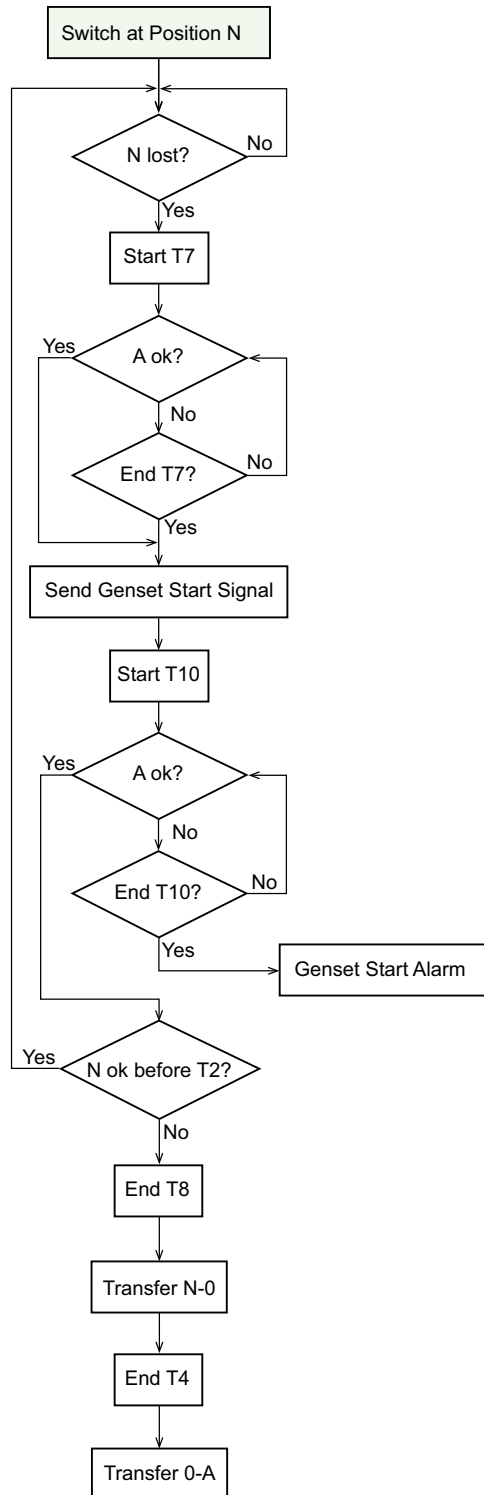

### Transfer Logic

- T2 will reset if N becomes unavailable
- If disable Genset Start Fail Warning, T10 will not be counted
- The whole transfer will be canceled if N becomes available during T7

# Control Mode and Transfer Logic

## Transfer Switching Equipment 32–160 A

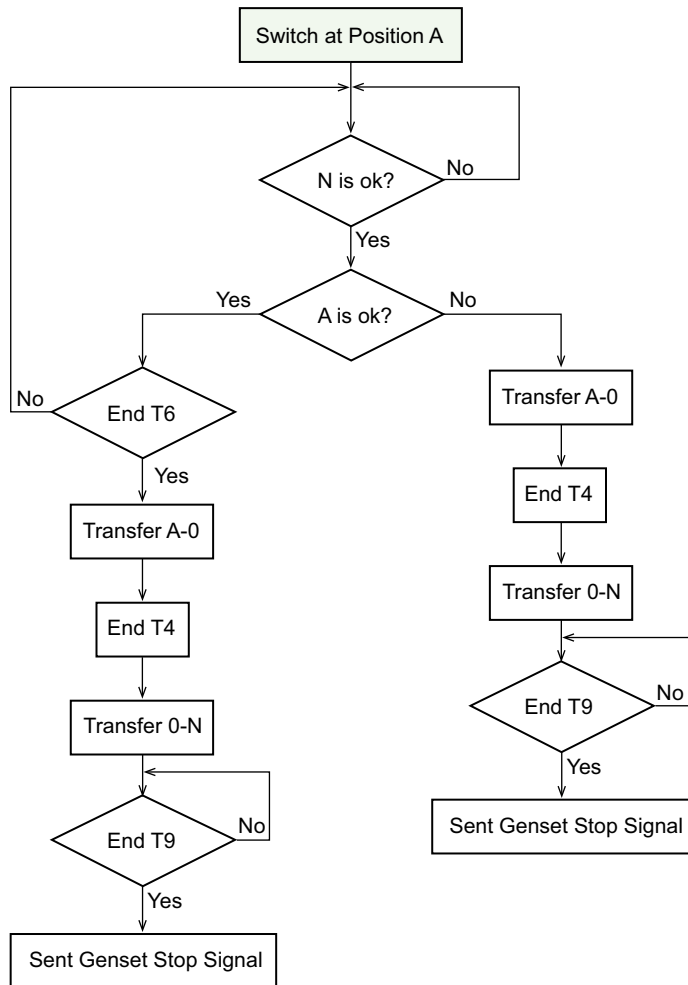

### Retransfer Logic

- T2 will reset if N becomes unavailable
- T6 will reset if N becomes unavailable
- During T6, if A is not available it will keep to count T6 if the rest time of T6 is shorter than T2. Other wise it goes to T2

# Control Mode and Transfer Logic Transfer Switching Equipment 32–160 A



## Non-return

In the non-return mode, after auto transfer to replacement, the ATSE will be connected to the alternate source until:

- An external order is given to transfer back to N source.
- The alternate source is out of range. In such case, the ATSE controller will transfer back to the N source to maintain power availability.

There will be only one time power off, when there is normal power outage.

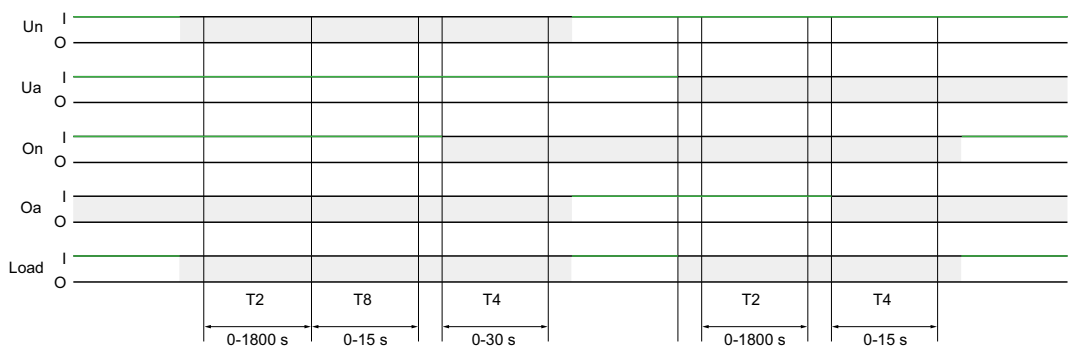

Symbols	Description
<b>Un</b>	Source I
<b>Ua</b>	Source II
<b>On</b>	contact close at N source
<b>Oa</b>	contact close at A source
<b>Load</b>	status
<b>T2</b>	Transfer delay
<b>T8</b>	Loadshed Delay
<b>T4</b>	Center-off Delay
<b>Key</b>	
O:	OFF (circuit open)
I:	ON (circuit closed)
■	No Power

# Control Mode and Transfer Logic Transfer Switching Equipment 32–160 A

## Logic of Non-return for U-U Application

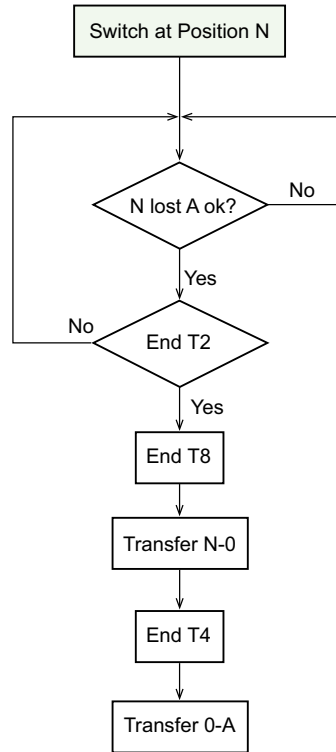

## Transfer Logic

\* T2 will reset if N becomes unavailable or A becomes unavailable

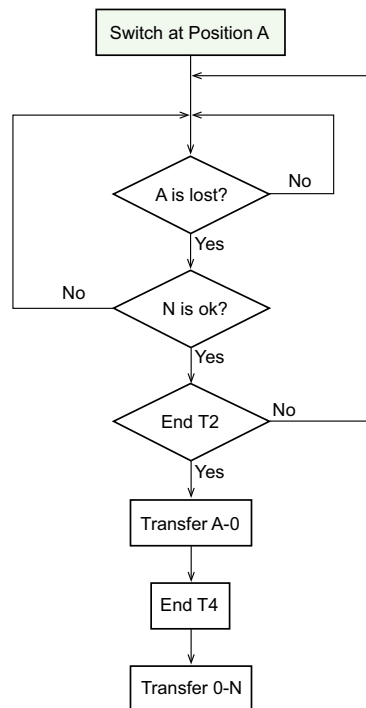

## Retransfer Logic

\* T2 will reset if N becomes unavailable



# Control Mode and Transfer Logic Transfer Switching Equipment 32–160 A

## Transfer Process of Non-return for U-G Application

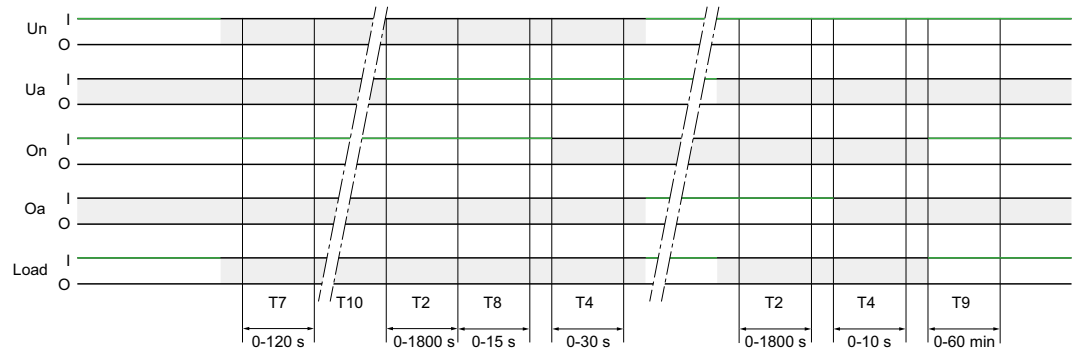

Symbols	Description
<b>Un</b>	Source I
<b>Ua</b>	Source II
<b>On</b>	Contact close at N source
<b>Oa</b>	Contact close at A source
<b>Load</b>	status
<b>T7</b>	Genset Start Delay
<b>T2</b>	Transfer delay
<b>T8</b>	Loadshed Delay
<b>T4</b>	Center-off Delay
<b>T9</b>	Genset Cool Delay
<b>Key</b>	
O: OFF (circuit open)	
I: ON (circuit closed)	
■ : No Power	

# Control Mode and Transfer Logic

## Transfer Switching Equipment 32–160 A

### Logic of Non-return for U-G Application

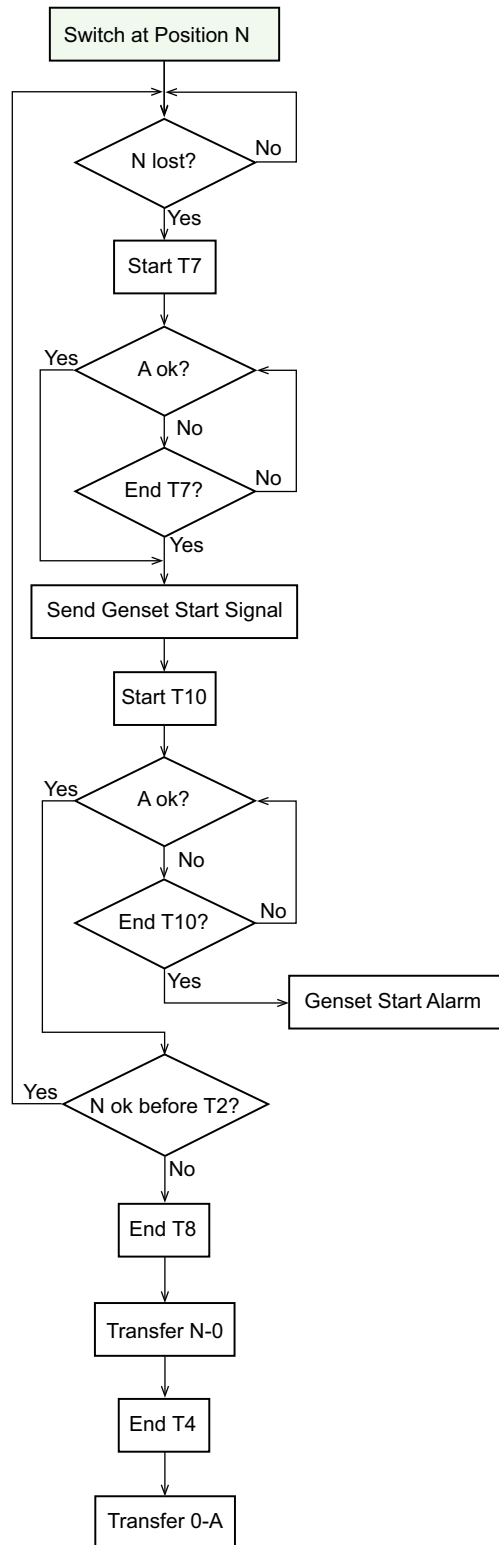

### Transfer Logic

- T2 will reset if N becomes unavailable or A becomes unavailable
- If disable Genset Start Fail Warning, T10 will not be counted

# Control Mode and Transfer Logic Transfer Switching Equipment 32–160 A

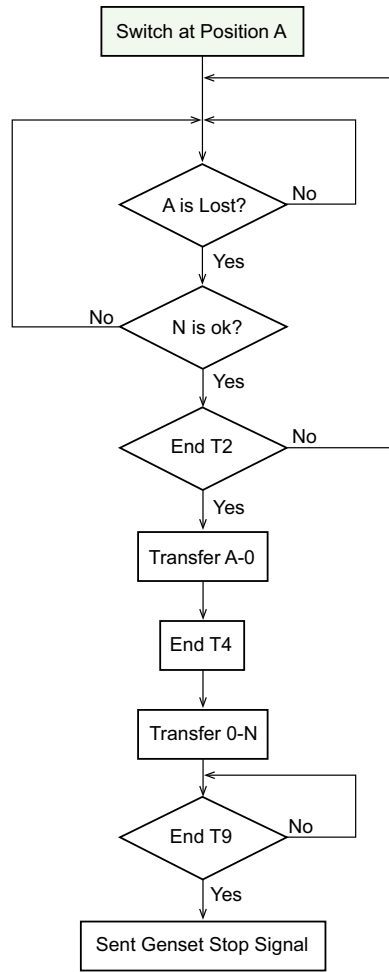

### Retransfer Logic

\* T2 will reset if N becomes unavailable

### Voluntary Transfer Mode

The voluntary transfer mode is equivalent to auto-priority mode on one source, with forced priority to the SI or SII source. It is activated when associated input is closed (The commercial reference number for the voluntary control module is TPCDIO08). It takes over 200 ms to active the voluntary mode. The signal for voluntary transfer should be constant.

Voluntary transfer is normally used for special tariffs. Once the mode is set from voluntary to N or A, ATSE is still remains in auto mode. When there is power contingency on target source, transfer switch can re-transfer to available source automatically.

NOTE: Auto transfer will not be active, if transfer action damages driving system (for example, both source are out of range, TSE refuses to transfer).

The following are the voluntary transfer mode use cases:

#### Use Case 1: Typhon Mode

During typhoon or earthquake, the Genset will be more stable than utility. The user for this case has installed a typhoon mode switch on his control panel. The user will activate the typhoon mode switch. It is connected to the input voluntary transfer mode which will transfer to alternate source (need accessory to have function of voluntary transfer using TPCDIO08 accessories). The ATSE will now activate the Genset output and will transfer to Genset once ready.

# Control Mode and Transfer Logic Transfer Switching Equipment 32–160 A

Now during the typhoon, the Genset is flooded. The ATSE will still be in auto mode. It detects alternate source failure. If the normal source is fine, it will try to transfer to normal source (voluntary is still an auto mode, and we have auto-return). If the normal source is not available then ATSE will not do any transfer. Still during typhoon, the Genset can restart (it was a fuel level problem). As the typhoon mode switch is still enabled, the ATSE will transfer back to the Genset. The Genset output keeps activate. So, whatever the source is connected, the typhoon is gone. The utility is back to normal. The user will deactivate the typhoon mode switch. The ATSE will be transfer back to normal source at auto mode with auto-return, U-G. The configuration needed is a ATSE along with voluntary transfer module. With this configuration, the user don't need to play with any ATSE settings (return mode, priority source, what is the normal source).

## Use Case 2: Peak Tariff (Align with Controller UA/BA)

Initially this feature was created in UA BA in France for Special Tariff Fare (STF) capability. Special Tariff Fare (STF) in France is a special electricity pricing that allows to have discount price on low consumption hours, with the drawback of having a very expensive kWh price on peak hours. With this option, EDF (French utility) provides an output on the energy meter to warn the end user about the price increase. This output is wired on the voluntary transfer input of the controller, which automatically transfers the load to a cheaper alternate source. This allows to help shedding the peaks on the network

## Transfer Logic of Voluntary to A (U-U Application)

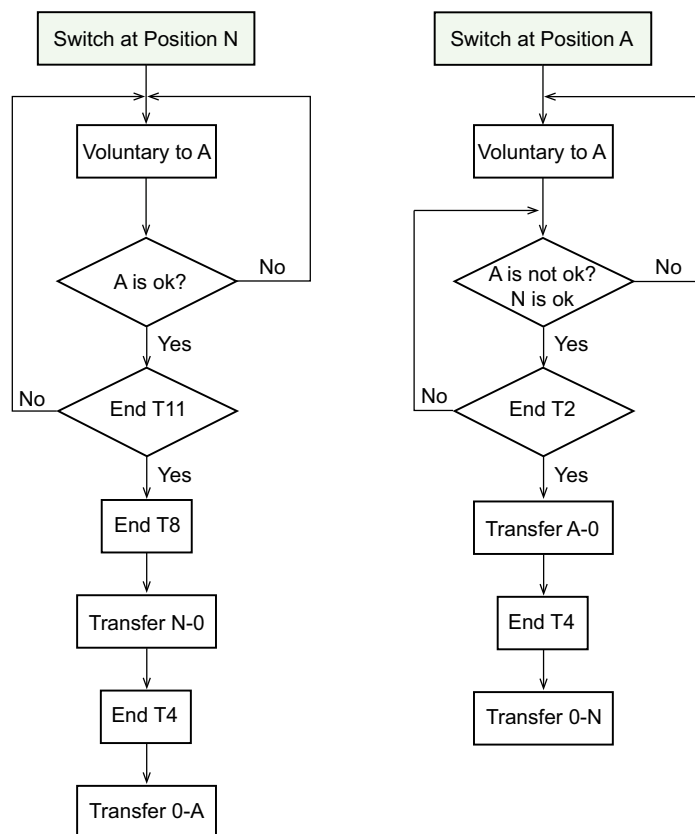

\* T11 is internal fixed time delay

# Control Mode and Transfer Logic Transfer Switching Equipment 32–160 A



## Transfer Logic of Voluntary to N (U-U Application)

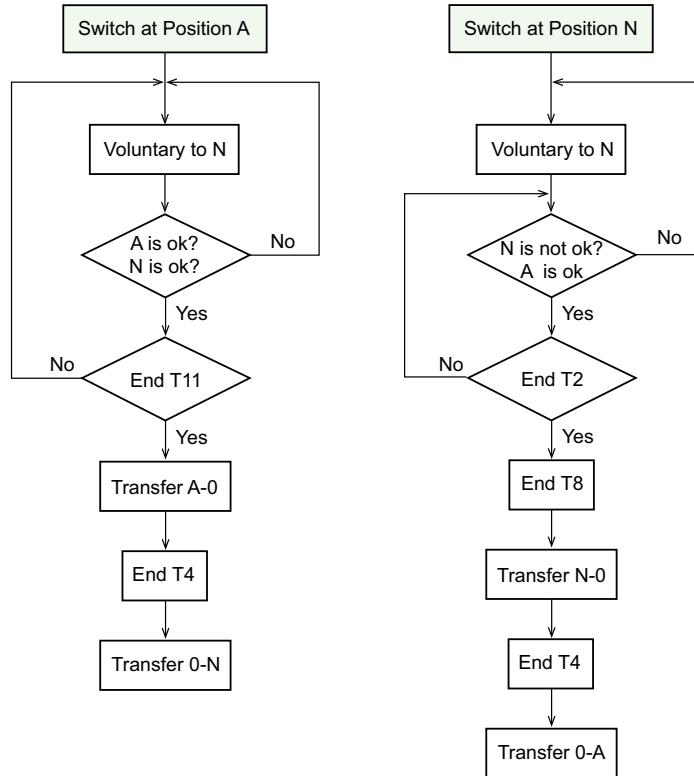

\* T11 is internal fixed time delay

## Transfer Logic of Voluntary to A (U-G Application)

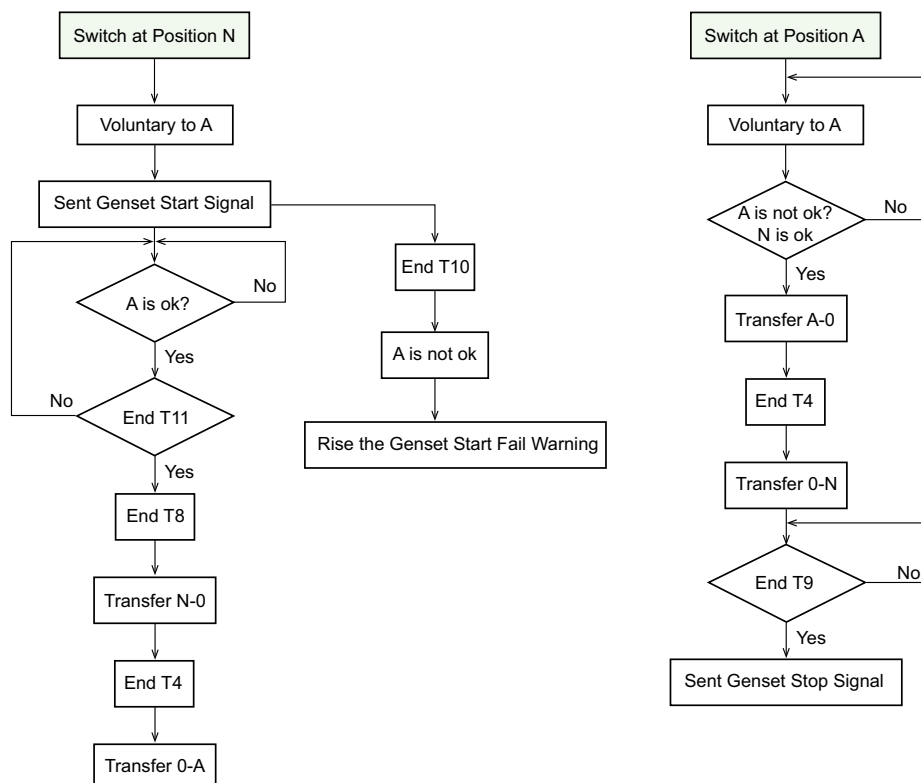

\* T11 is internal fixed time delay

# Control Mode and Transfer Logic Transfer Switching Equipment 32–160 A

## Transfer Logic of Voluntary to N (U-G Application)

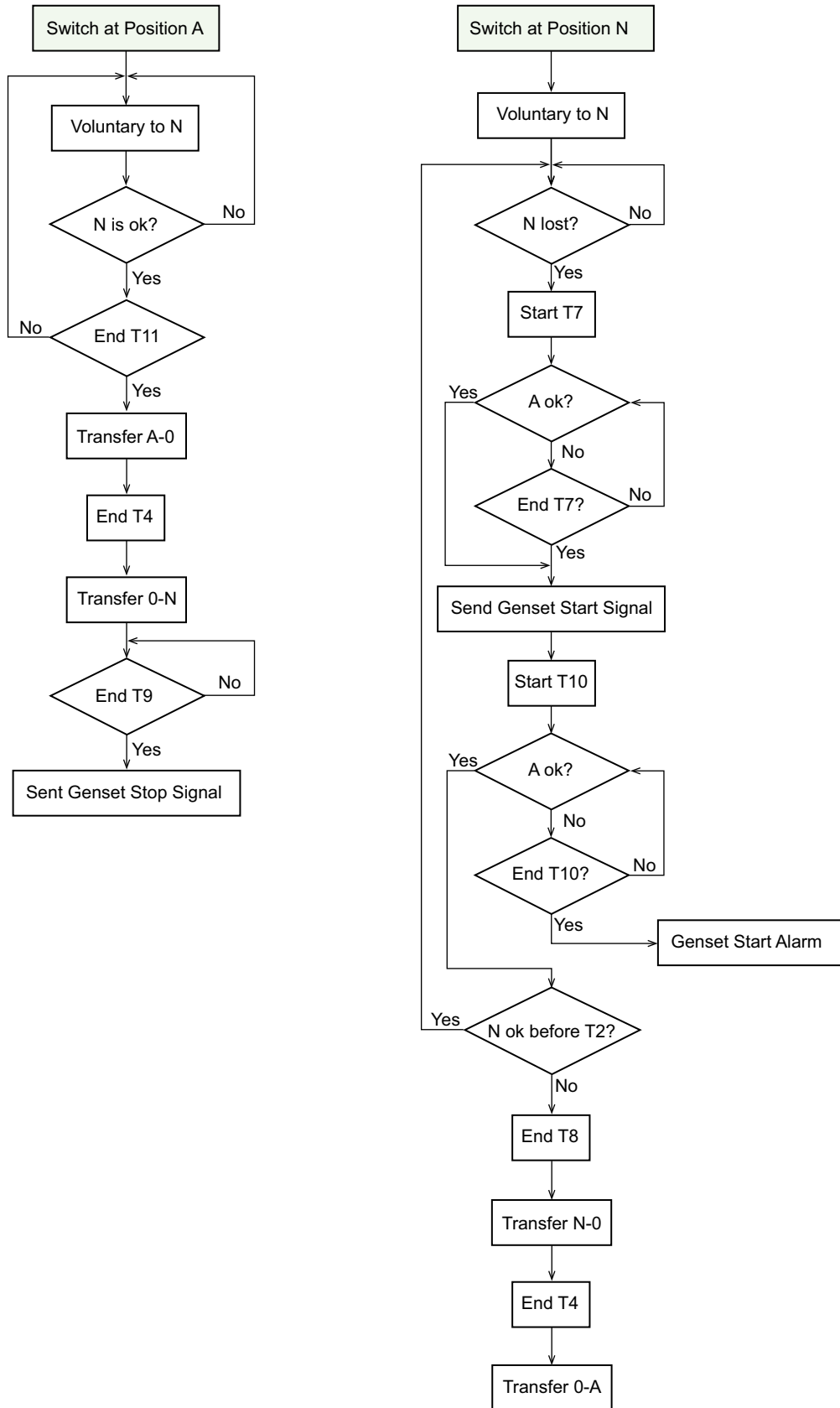

\* T11 is internal fixed time delay

# Control Mode and Transfer Logic

## Transfer Switching Equipment 32–160 A

### Test Mode

The test mode is a procedure to simulate the transfer process with following purpose:

- Test normal transfer actions for ATSE-On load test.
- Test Genset-Off load test
- Test Genset-Transfer functions-On load test

### Ways Test

There are two ways to conduct the test:

- Through Active Automatic HMI.
- Through DI using TPCDIO07 accessories.

No priority difference between HMI command or DI command. ATSE will act upon receiving the command given.

### Default Time for Test

- Default as unlimited test (No time duration, has to stop the test manually).
- If select limited test, the default time duration is 30s.

### Time Range for Test

- 10 s–1800 s with steps of 1 s.
- Time delay can be bypassed by pressing ESC key in Active Automatic HMI.

### Pre-Condition to Start Test Mode

The following conditions are mandatory for the test:

- ATSE is in auto mode.
- ATSE is in normal position while in U to U Application.
- ATSE is in alternate position while in U to U Application.
- ATSE is in normal position while in U to G Application.
- For U-U application, R source shall be available before test. Otherwise, there will be an alarm.

**NOTE:** On load test will not be active, if transfer action damage driving system (for example, both source are out of range, TSE refuses to transfer).

A

# Control Mode and Transfer Logic Transfer Switching Equipment 32–160 A

## Off Load Test

- The purpose of this function is to check the Genset can start, without power interruption.
- NOTE:**
- This test does not check if the switch is able to make the transfer.
  - The test is only available with U-G configuration.
- The offload test should not be proposed, when the ATSE doesn't have Genset output feature.
  - This function will only be accessible for product with HMI, as the Test mode default value is On load.
  - The orders from higher priority will interrupt the test procedure.

## Logic of Off Load Test U-U

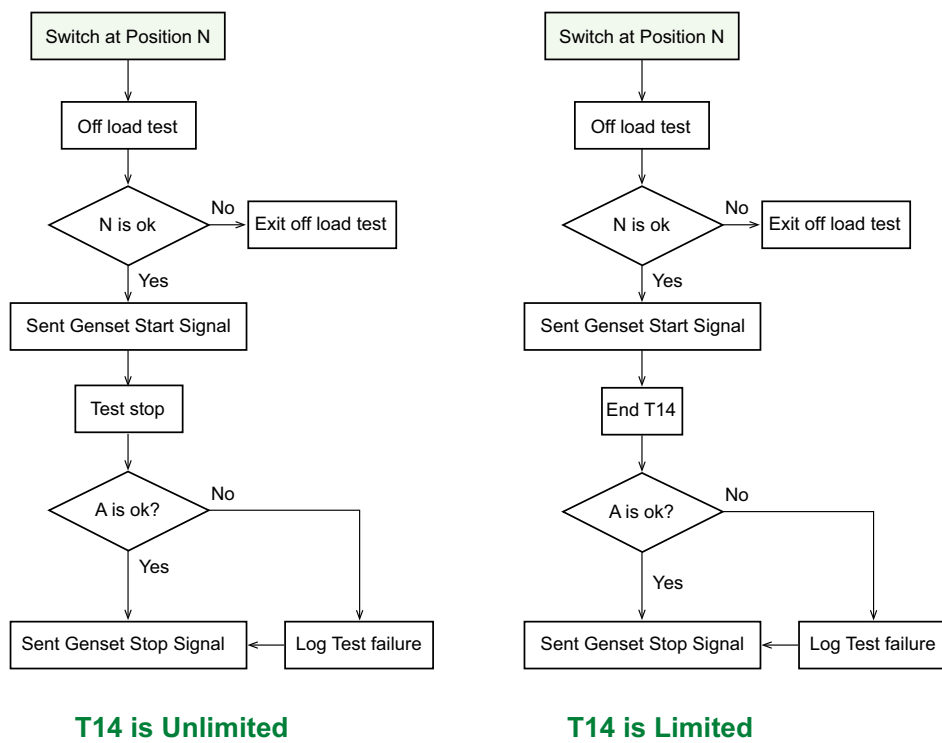



# Control Mode and Transfer Logic Transfer Switching Equipment 32–160 A



## On Load Test

- The purpose of this function is to execute ATSE transfer (when the source is still valid) to make sure the system is still able to execute the transfer. The UU and U-G configuration are both available.
- When the ATSE receive the testing start request:
  - The ATSE shall initiate the transfer to the Alternate source if the Alternate source is in range, and according to the transfer delays (T7, T2...).
  - The ATSE shall log a test start event.
- Two conditions to return to N source:
  - When the ATSE receive the stop request from user.
  - When the Test timer is activated, and the test timer is completed.

## Logic of On Load Test U-U

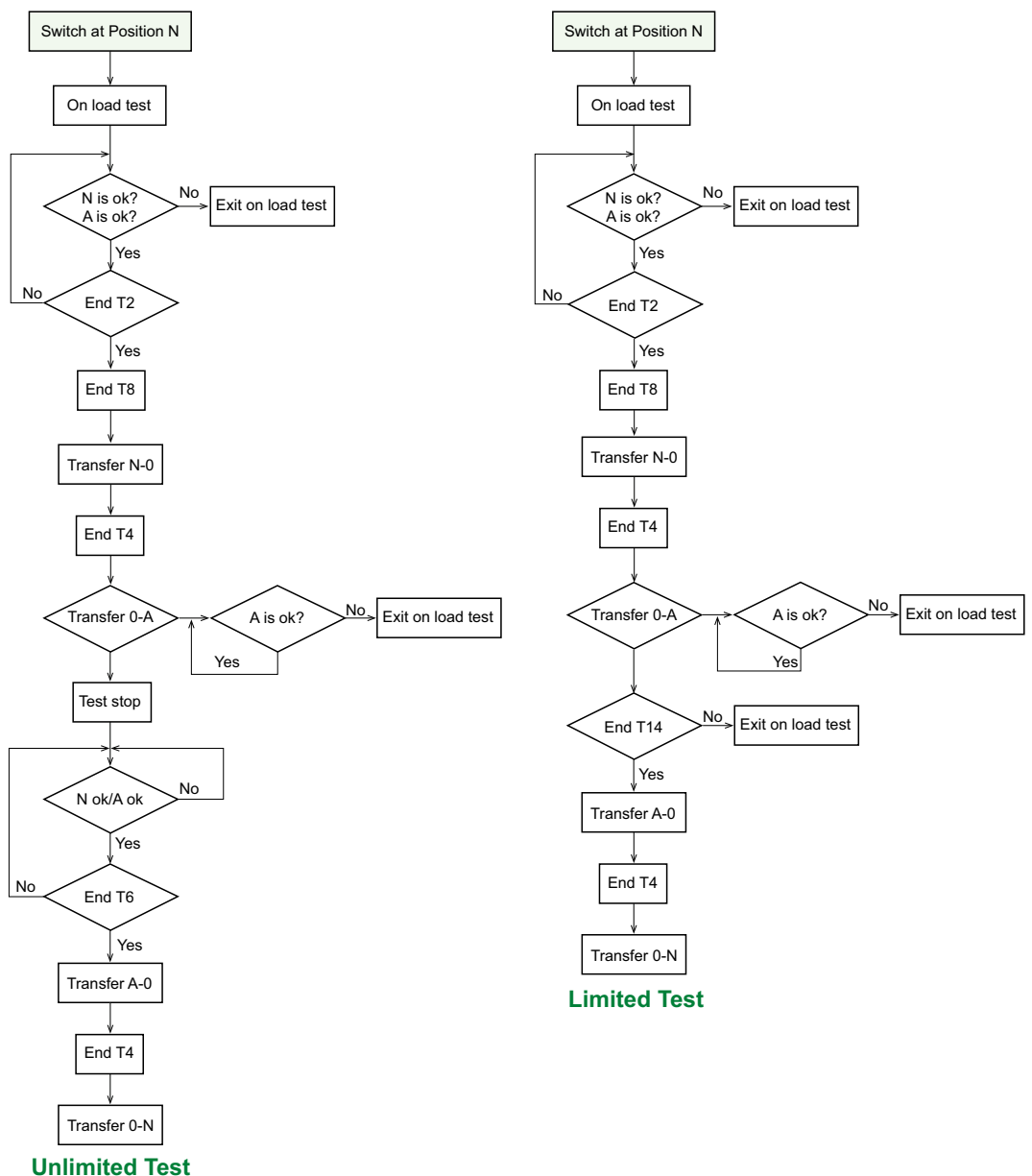

# Control Mode and Transfer Logic Transfer Switching Equipment 32–160 A

## Logic of On Load Test U-G

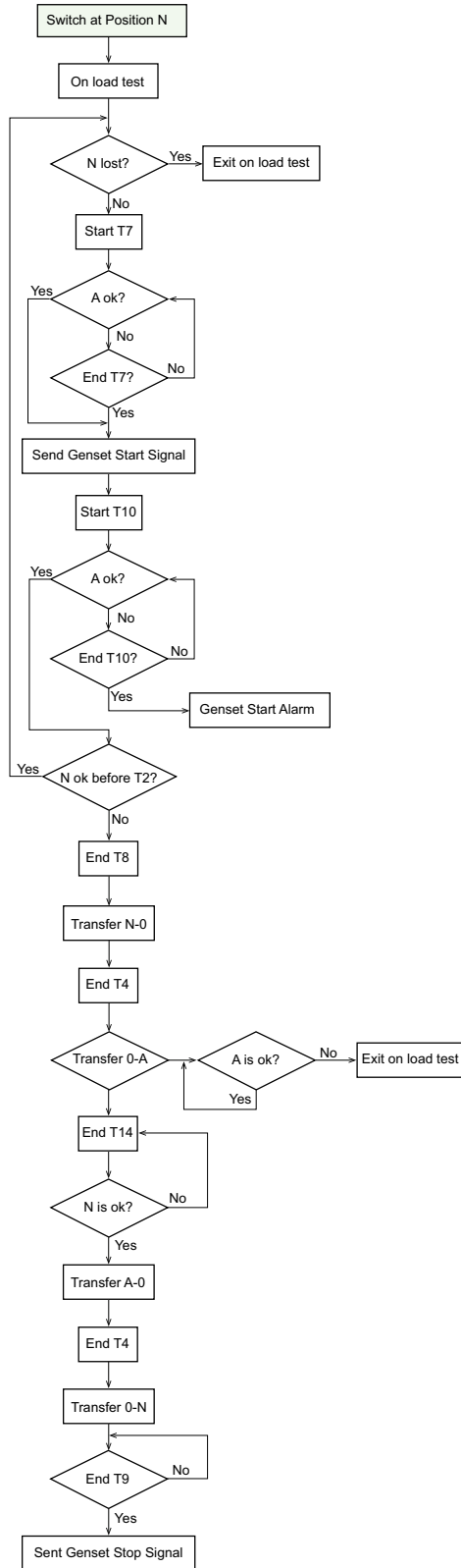

### Limited Test

# Control Mode and Transfer Logic Transfer Switching Equipment 32–160 A

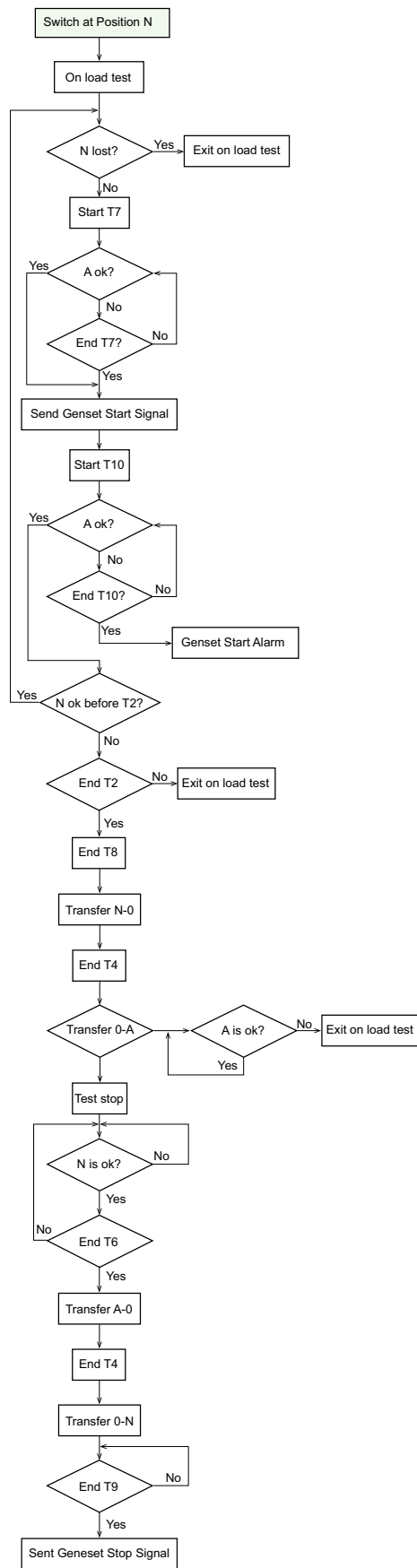

Unlimited Test

# Control Mode and Transfer Logic Transfer Switching Equipment 32–160 A

## Return or Start from Auto Mode at Off Position

When switch is at OFF position, this state is interim, and it happens under two conditions:

- Enter the auto mode from other modes or from power on.
  - End of off delay (T4), ATSE is unable to switch to N or A, due to both power source loss (with 24 V).
- The load shedding will be activated from OFF to A source in both U-U and U-G configuration.

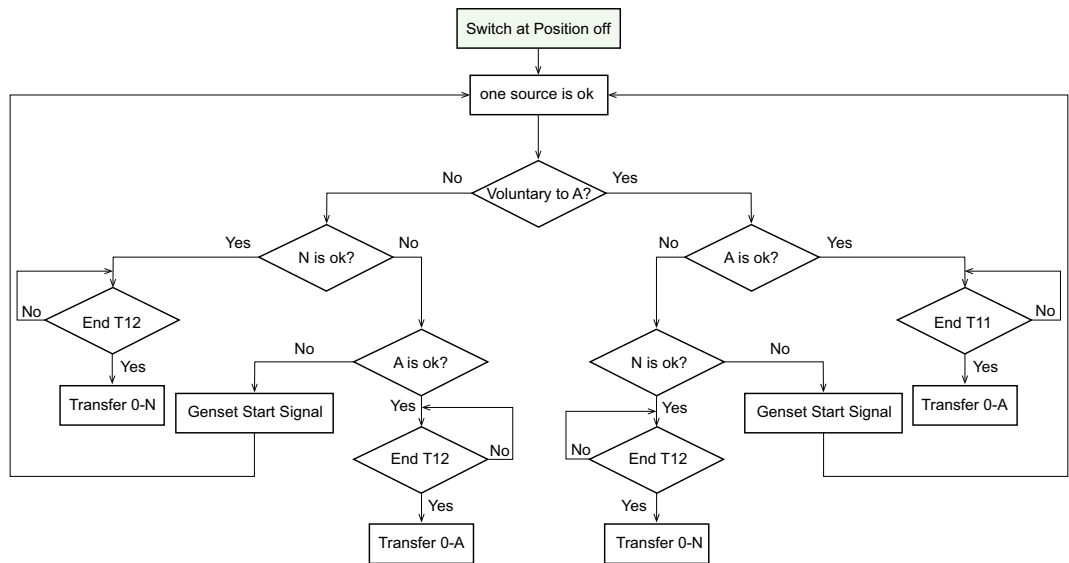

\* T12 is internal fixed time delay.

## Local Control Mode

<b>⚠ CAUTION</b>
<p><b>HAZARD OF EQUIPMENT DAMAGE</b></p> <p>Enable the local control through Active Automatic HMI to exit the auto mode.</p> <p><b>Failure to follow these instructions can result in injury or equipment damage.</b></p>

<b>NOTICE</b>
<p><b>POTENTIAL POWER OUTAGE OF EQUIPMENT</b></p> <p>To re-enter Auto mode, disable local control through Active Automatic HMI or External HMI.</p> <p><b>Failure to follow these instructions can result in equipment damage.</b></p>

The local mode is activated through the HMI (only available for Active Automatic, RS version change to Automatic). It allows locally to change the logical position of the TSE. The switch will refuse to active if the action will damage the driving system. It cannot transfer to unavailable source.

**NOTE:** Local transfer will not be active, if transfer action damage driving system (for example, both overvoltage are out of range, TSE refuses to transfer) or both sources are out of operating voltage of solenoid.

Auto Genset start signal and load shedding signal is not available for this mode. In this case, the target source conformity is verified before transfer and time delays are not considered.

# Control Mode and Transfer Logic Transfer Switching Equipment 32–160 A

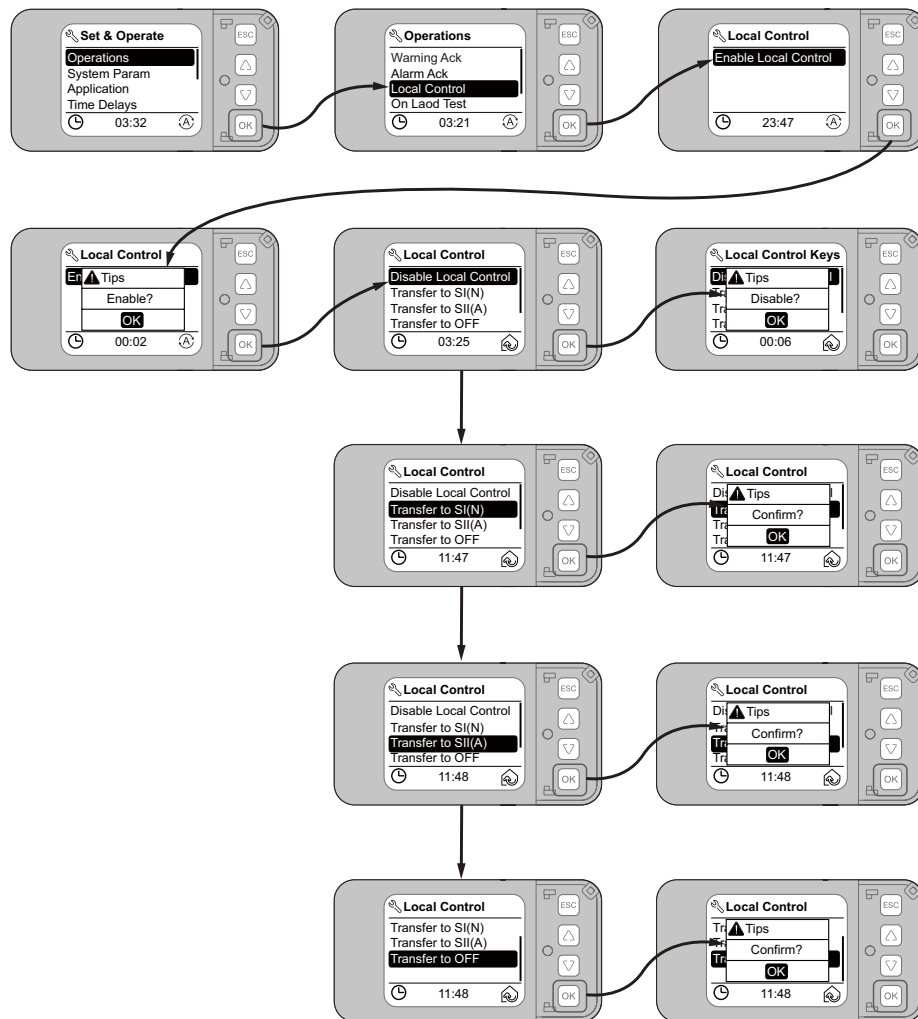

## Local Control to N

The command is sent through HMI. There is no time delay except OFF delay. The switch will transfer to normal after receiving the order to it when normal power is in tolerance.

## Local Control to A

The command is sent through HMI. There is no time delay except OFF delay. The switch will transfer to alternate after receiving the order to it when alternate power is in tolerance.

## Local Control to O

The command is sent through HMI. There shall be no time delay. The switch will transfer to OFF after receiving the order to it.

# Control Mode and Transfer Logic

## Transfer Switching Equipment 32–160 A

### Transfer Inhibit Mode

When the transfer inhibition input is active, the controller can not send any order to TSE. Front face selection buttons are locked and the HMI only display transfer inhibit.

Fire, Force to OFF and Handle mode still works as before. When exit Fire, Force to OFF and Handle mode, transferring blocked by transfer inhibit.

Use this mode only when inhibit signal (from DI) is active and no higher operation mode is running. When ATS transfer is ongoing, wait until transfer completed.

Exit this mode after inhibit signal is inactive.

Accessories are required using TPCDIO07 to extend this function of the TSE.

### Application

- Transfer inhibit occurs when there is power interruption because of short circuit.
- This function can be used to lock the controller by customized signals.
- This function can be used for cooperation with different ATSE.

### Fire Protection Mode

- An emergency stop order to transfer ATSE to off position. All the other transfer mode will be canceled except force to OFF and handle control. There shall be no time delay.
- Exit fire protection after signal disappeared.
- Require accessories TPCDIO10 or TPCDIO11 or TPCDIO13 or TPCDIO14 to extend this function.
- Fire protection will not be activated if transfer action damages driving system.

### Application

- The fire protection signal can transfer ATSE to off position when there is fire emergency.

### Force to OFF Mode

- Transfer ATSE to OFF position with an emergency stop order. All the other transfer mode will be canceled except handle control. There should be no time delay.
- Exit Force after signal disappeared.
- Accessories are required using TPCDIO07 to extend this function of TSE.

### Handle Transfer Mode

- The handle or manual transfer mode is activated from the TSE directly. It deactivates the controller control function except position status (outputs and LEDs), source status LEDs and alarm LED.
- No operation for load shedding and generator, keep the status as before.
- No alarm relay output.

# Automatic Transfer Switching Equipment

Class PC

TransferPacT Active Automatic and Automatic  
Frame 100/2P, 3P, 4P

Minimum electrical Clearance

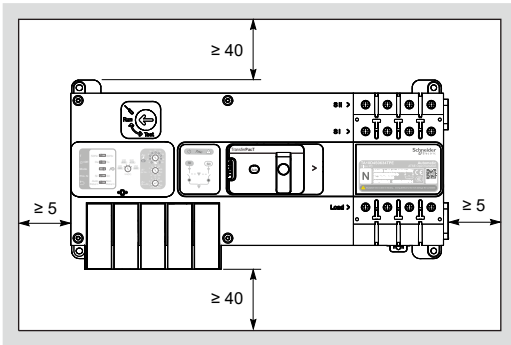

**Bare product**

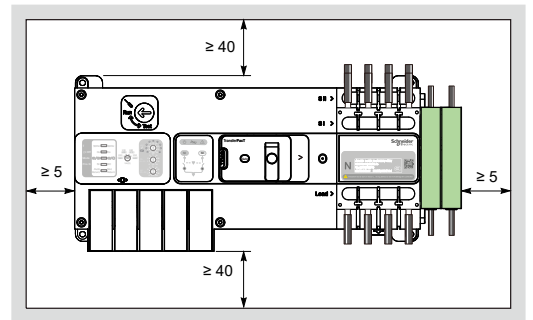

**With Auxiliary Contact**

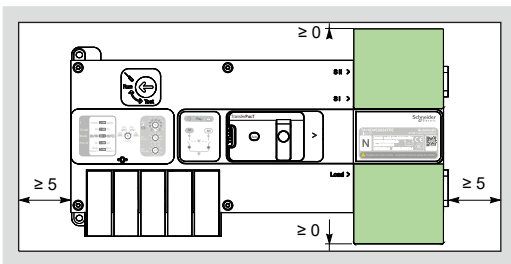

**With Terminal Shield**

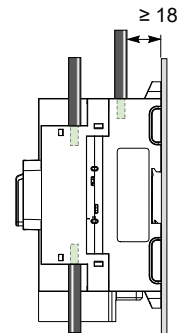
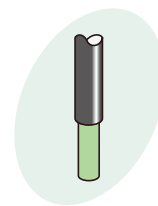

**Cable to base plate**

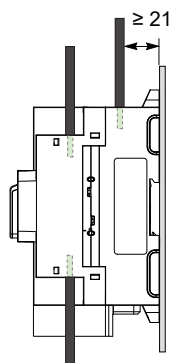
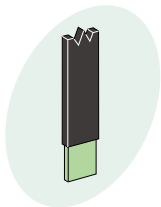

**Busbar to base plate**

# Automatic Transfer Switching Equipment

Class PC

TransferPacT Active Automatic and Automatic  
Frame 160/3P, 4P

Minimum electrical Clearance

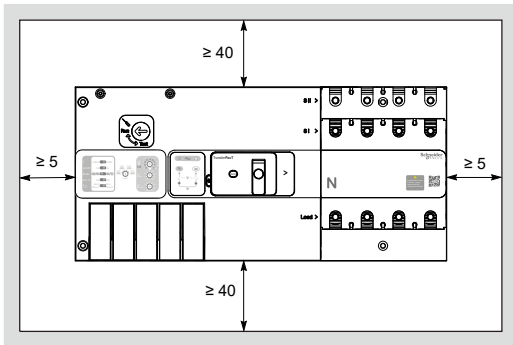

**Bare product**

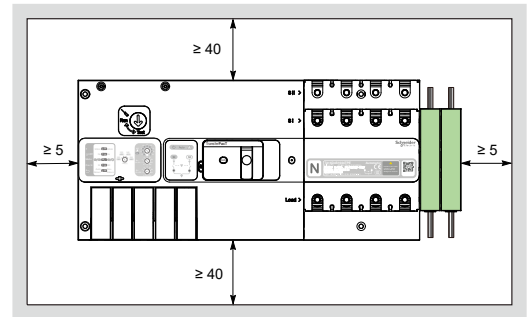

**With Auxiliary Contact**

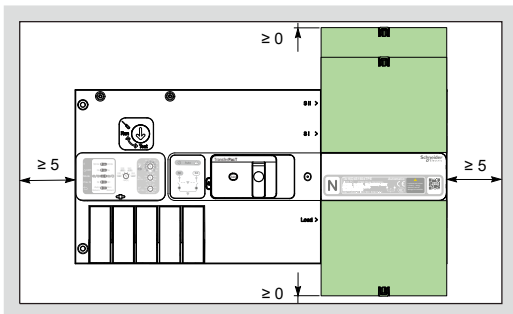

**With Terminal Shield**

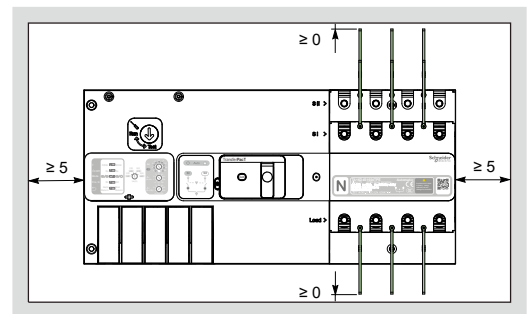

**With Interphase barriers**

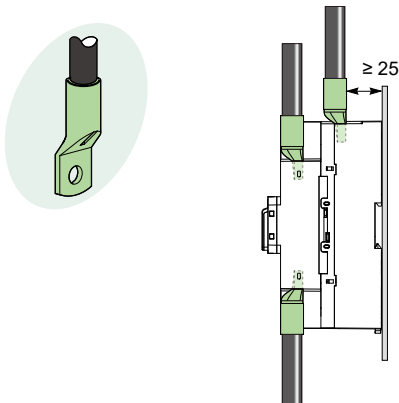

**Crimp lug to base plate**

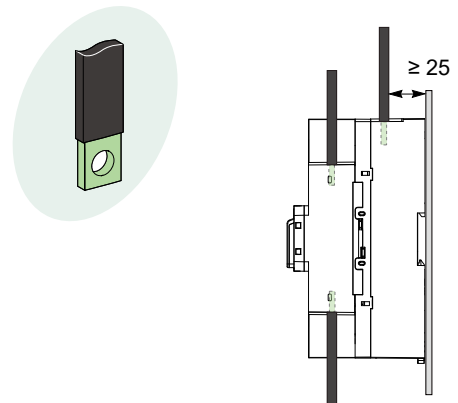

**Busbar to base plate**



# Automatic Transfer Switching Equipment

Class PC

TransferPacT Active Automatic and Automatic  
Frame 100/2P, 3P, 4P

Dimensions

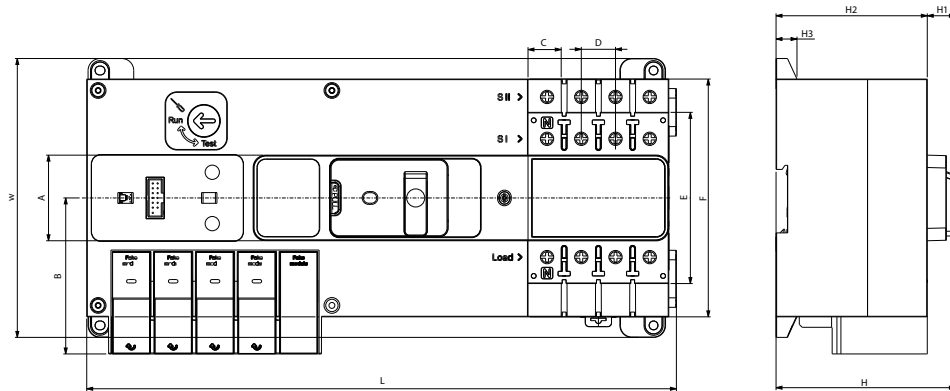

Panel and Front panel cut

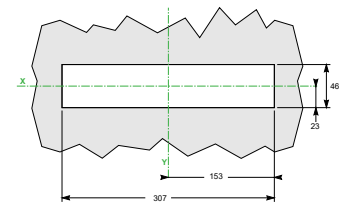
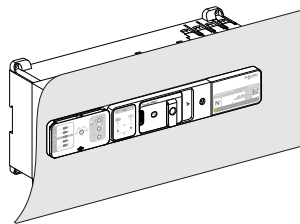
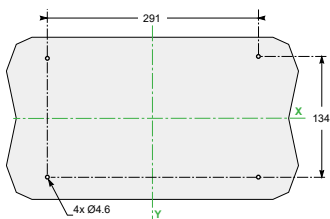

Frame	L	W	H	A	B	C	D	E	F	H1	H2	H3
100	310	147	94	45	82	17.5	18	90	125	15	79.5	11

# Automatic Transfer Switching Equipment

Class PC

TransferPacT Active Automatic&Automatic

Frame 160 / 3P, 4P

## Dimensions

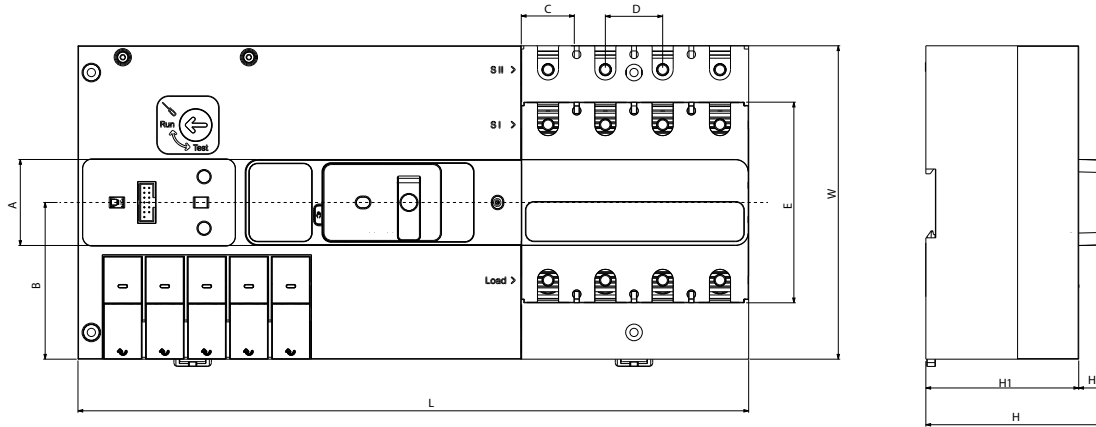

## Panel and Front panel cut

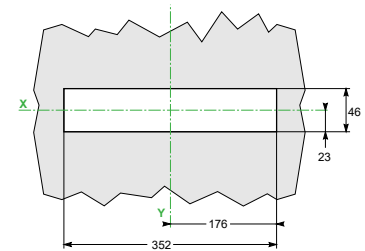
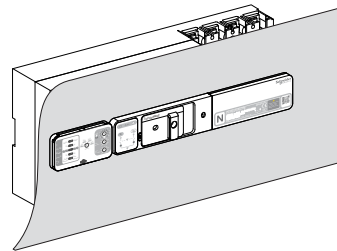
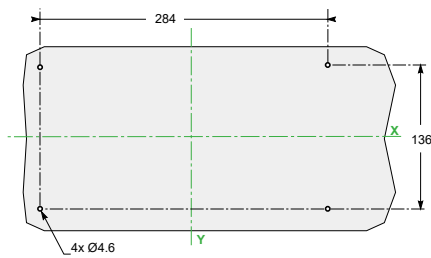

Frame	L	W	H	A	B	C	D	E	F	H1	H2	H3
160	351	164	95	45	82	28	30	105		80	15	

# Automatic Transfer Switching Equipment

## TransfePacT Active Automatic

Class PC

### External HMI

#### Overview

The external HMI is used to display the HMI on the panel. The HMI consists of external HMI base and a LCD screen.

The external HMI must be connected with the function module with commercial reference as TPCDIO15. The connection of the external HMI is done using a cable and an external HMI base and LCD display.

#### Position of External HMI and Switch

Perform the following procedure to connect the external HMI on the panel door:

1. Rotate the external HMI to the back side.
2. Remove the nut of external HMI.
3. Insert the external HMI on the front door.

NOTE: Please make the cutout on the front door as per the dimension given.

4. Insert the nut.
5. Lock the nut.
6. Insert the cable into the external HMI.
7. Insert the other end of the cable into the function module (TPCDIO15).

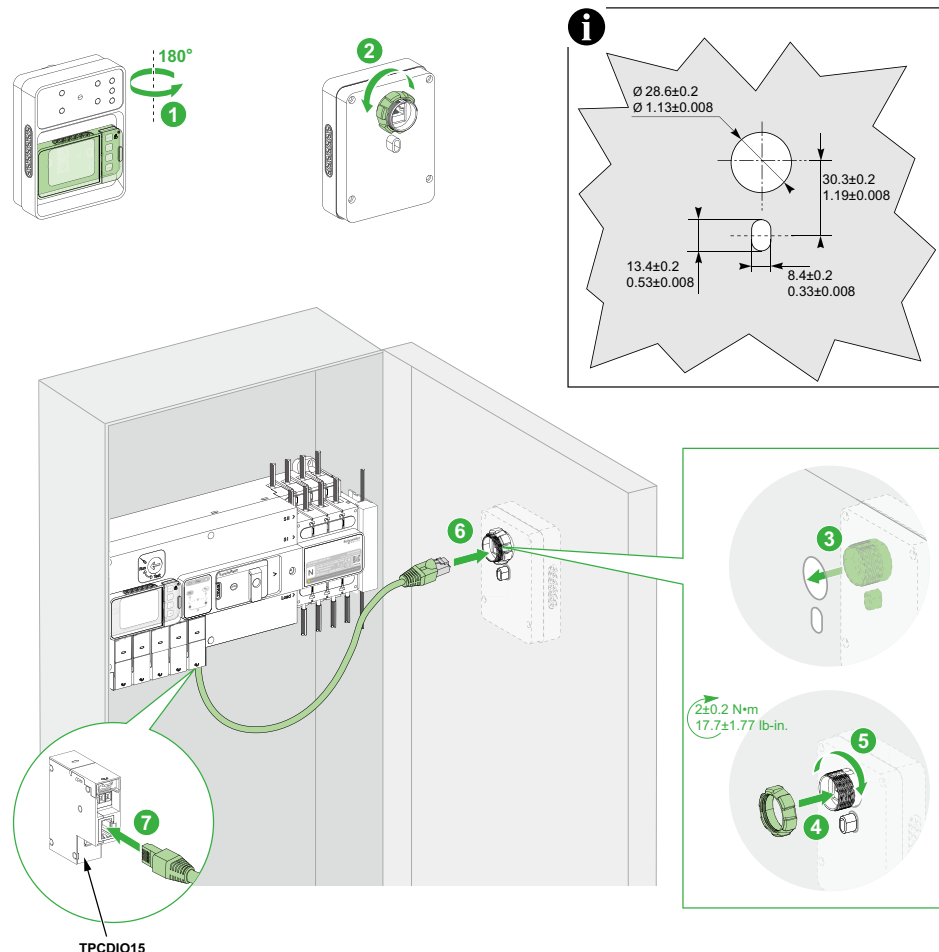

# Automatic Transfer Switching Equipment

## TransferPacT Active Automatic and Automatic

### Auxiliary Contact

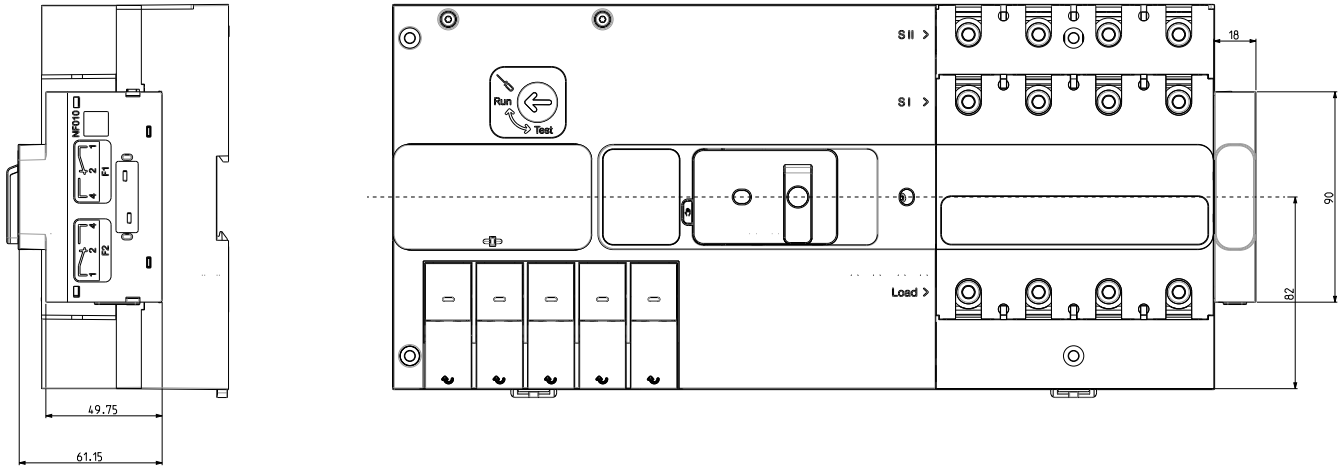

# Automatic Transfer Switching Equipment

Class PC

TransferPacT Active Automatic TransferPacT , Frame 100, Wiring capacity



### Dimensions for Frame 100

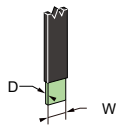
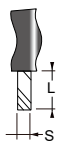
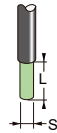

Pole partition	(mm)	18
Cable-Rigid Cu/Al	L (mm)	≤ 13
	S (mm <sup>2</sup> )	≤ 1.5-35
Cable-Flexible Cu/Al	L (mm)	≤ 13
	S (mm <sup>2</sup> )	≤ 1-35
Bar	W (mm)	≤ 10
	D (mm)	≤ 5
Torque	(Nm)	3.5±0.3

### Dimensions for Frame 160

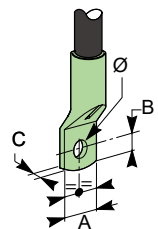
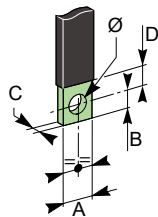

Pole partition	(mm)	30
Bars	A (mm)	≤ 20
	B (mm)	≤ 6
	C (mm)	≤ 6
	D (mm)	12 ≤ D ≤ 14
	Ø (mm)	≥ 6.4
Cable with Crimp Lug	A (mm)	≤ 20
	B (mm)	≤ 6
	C (mm)	≤ 6
	Ø (mm)	≥ 6.4
Torque	(Nm)	8±0.8

# Installation recommendation

## Use at high temperatures

### Power dissipated and resistance per pole

TransferPacT	40	63	80	100	125	160
Rating (A)	40	63	80	100	125	160
Resistance per pole (mΩ)	0.3	0.3	0.3	0.2	0.2	0.2
Power dissipated per pole (W)	0.5	1.2	1.9	2	3.1	5.1

### Temperature derating

TransferPacT	40	63	80	100	125	160
--------------	----	----	----	-----	-----	-----

#### Front connection with bare-cable connectors or lugs

Thermal current I <sub>th</sub> at	60 °C	40	63	80	100	125	160
65 °C	40	63	80	100	125	160	
70 °C	40	63	80	100	125	150	

TransferPacT	100	160
--------------	-----	-----

#### Front connection

Thermal current I <sub>th</sub> at	60 °C	100	160
65 °C	100	160	
70 °C	100	160	

#### Front connection with right-angle terminal extension + bare-cable connectors

Thermal current I <sub>th</sub> at	55 °C	100	160
60 °C	100	160	
65 °C	100	160	
70 °C	100	160	

# Automatic Transfer Switching Equipment

## TransferPacT Active Automatic and Automatic

### Wiring Diagrams for frame 100: 32-100 A

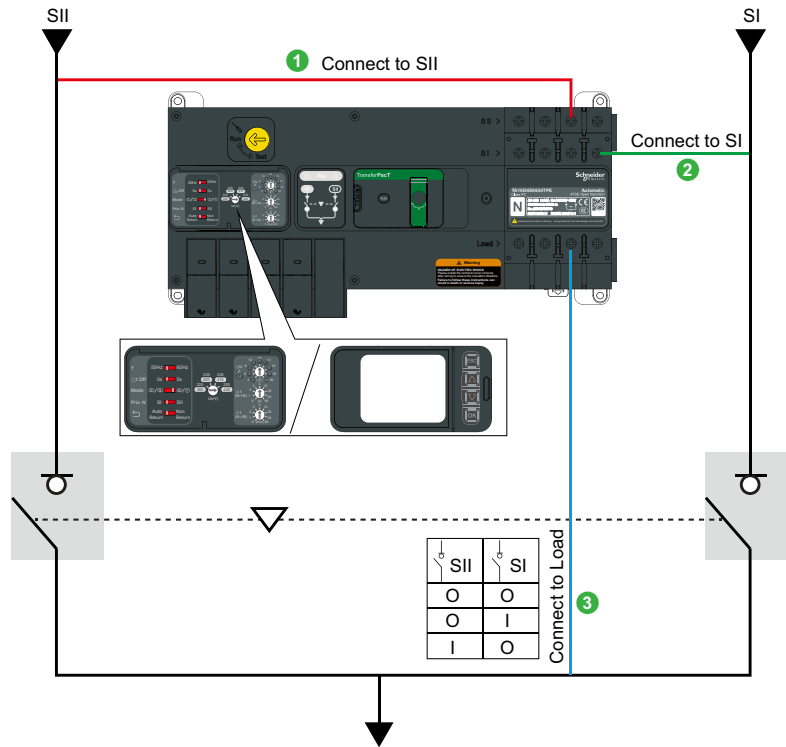

3P/4P

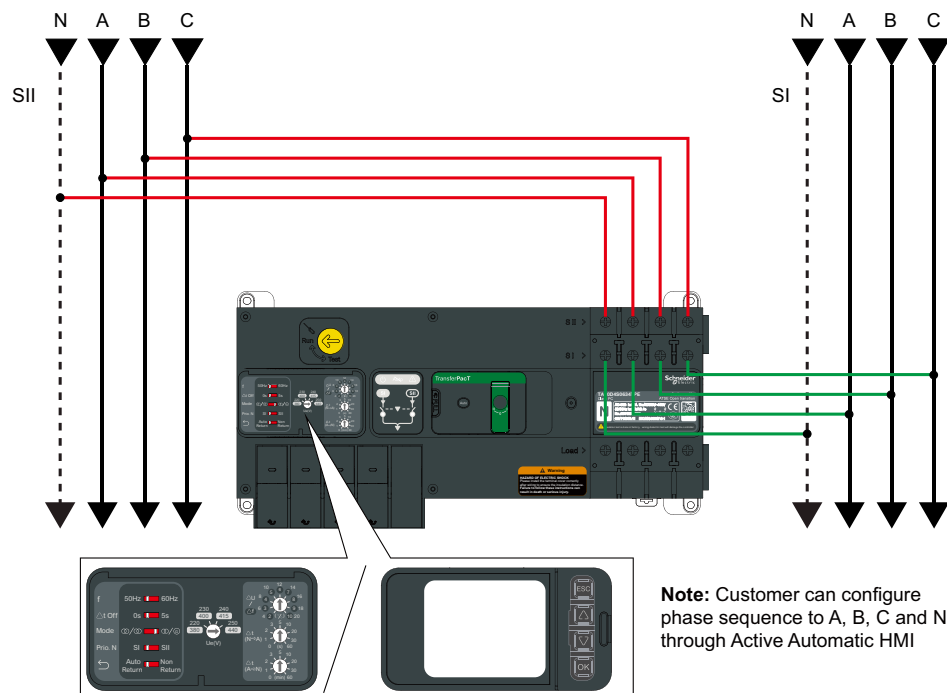

# Automatic Transfer Switching Equipment

## TransferPacT Active Automatic and Automatic

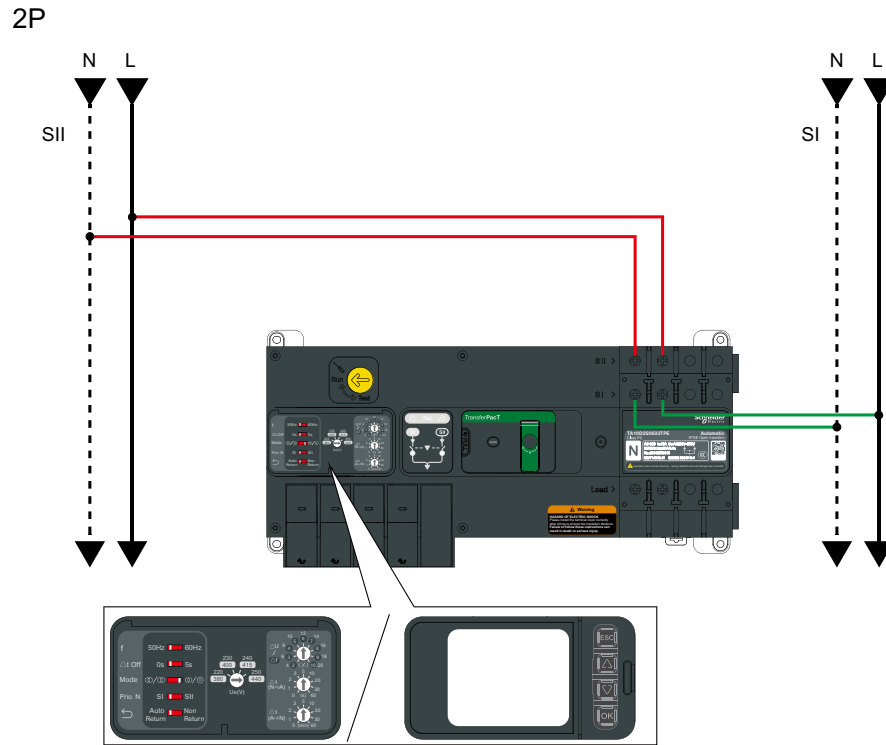



# Automatic Transfer Switching Equipment

## TransferPacT Active Automatic and Automatic

### Wiring Diagrams for frame 160: 80-160 A

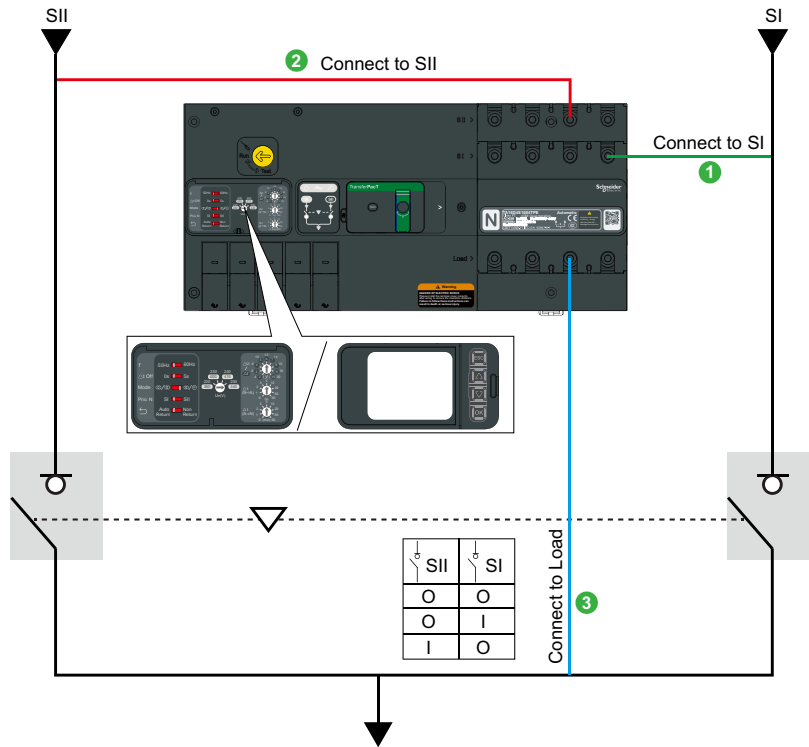

### 3P/4P

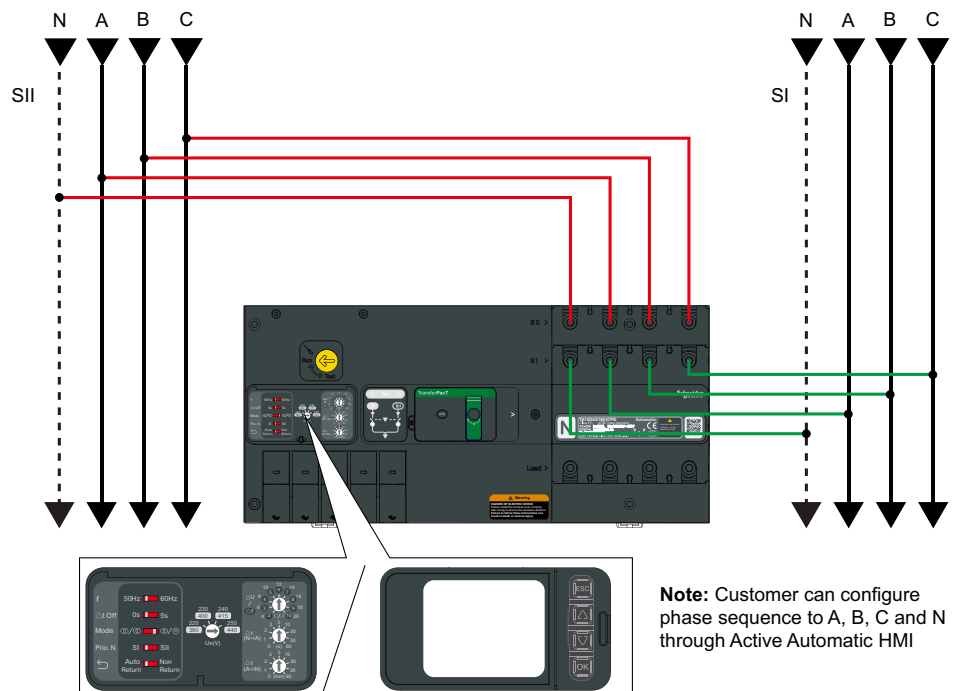

# Automatic Transfer Switching Equipment Function Module

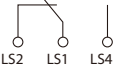
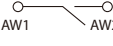
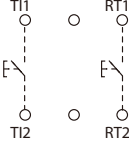
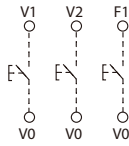
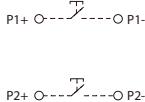
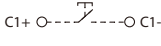
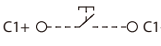
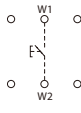
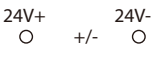
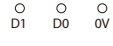
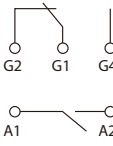
	Maximum Qty per product	Terminal code	terminal definition
 <p>LS2 LS1 LS4</p>	1	LS1,LS2,LS4	loadshedding signal output
 <p>AW1 AW2</p> <p>TPCDIO05</p>		AW1,AW2	Availability warning output
 <p>TI1 RT1 TI2 RT2</p> <p>TPCDIO07</p>	1	TI1,TI2 RT1,RT2	Transfer Inhibit signal input, short to work Remote testing input,short to work
 <p>V1 V2 F1 V0 V0 V0</p> <p>TPCDIO08</p>	1	V0,V1 V0,V2 V0,F1	short to Transfer to Normal short to Transfer to Alternate short to Transfer to OFF
 <p>P1+ P1- P2+ P2-</p> <p>TPCDIO10</p>	1	P1+,P1- P2+,P2-	DC24 V pluse signal,enable fire protetion DC24 V pluse signal,diable fire protection
 <p>C1+ C1-</p> <p>TPCDIO11</p>	1	C1+,C1-	DC24 V constant signal,enable fire protetion
 <p>C1+ C1-</p> <p>TPCDIO13</p>	1	C1+,C1-	AC230 V constant signal,enable fire protetion
 <p>W1 W2</p> <p>TPCDIO14</p>	1	W1,W2	Short to enable fire protetion
 <p>24V+ 24V- +/-</p> <p>TPCDIO15</p>	1	24V+,24V- RJ45	DC 24 V external power port (auxiliary supply) Bus extension
 <p>D1 D0 0V</p> <p>TPCCOM16</p>	2	D1,D0,0V	modbus communication port
 <p>G2 G1 G4 A1 A2</p> <p>TPCDIO17</p>	1	G1,G2,G4 A1,A2	Genset start signal output Alarming output

**NOTE:** for detailed function module terminal definition and default settings, refer to user guide DOCA0214EN-00

# Automatic Transfer Switching Equipment Auxiliary Contact

## TPSAUX32



- (A) SI open
- (B) SI closed
- (C) SII open
- (D) SII closed

Transfer switching equipment is closed at SI:

- F11-F14 is closed
- F11-F12 is opened

Transfer switching equipment is closed at SII:

- F21-F24 is closed
- F21-F22 is opened

Transfer switching equipment is at OFF position:

- F11-F12 and F21-F22 are closed
- F11-F14 and F21-F24 are opened

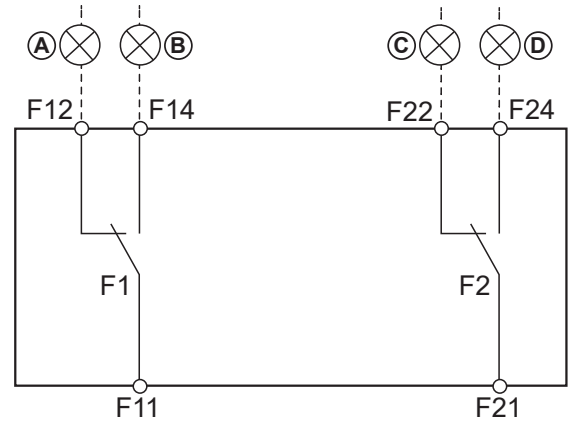

## TPSAUX33



Transfer switching equipment is at OFF position:

F12-F22 is closed

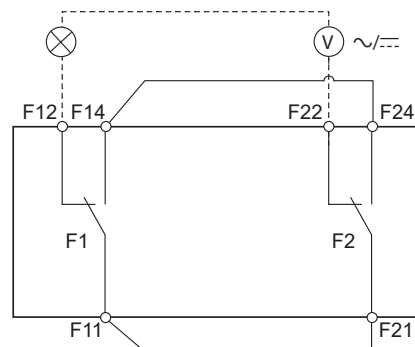

Transfer switching equipment is not at OFF position:

F11-F14 and F21-F24 are closed

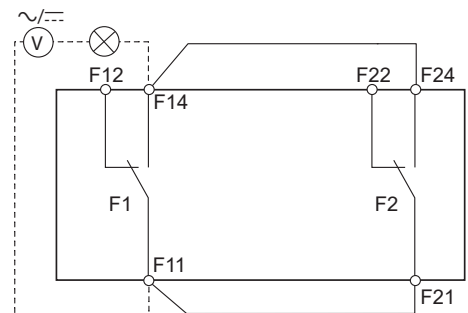

**NOTE:** terminal capacity for auxiliary contact is AC250 V 2 A.

# Coding Principle

The commercial reference of TransferPacT Automatic Transfer Switching Equipment is coded with significant features to explain the type of frame rating, transition, controller type, rated voltage, rated current and number of poles



TA1 8DAL160ATPE-ISO.png

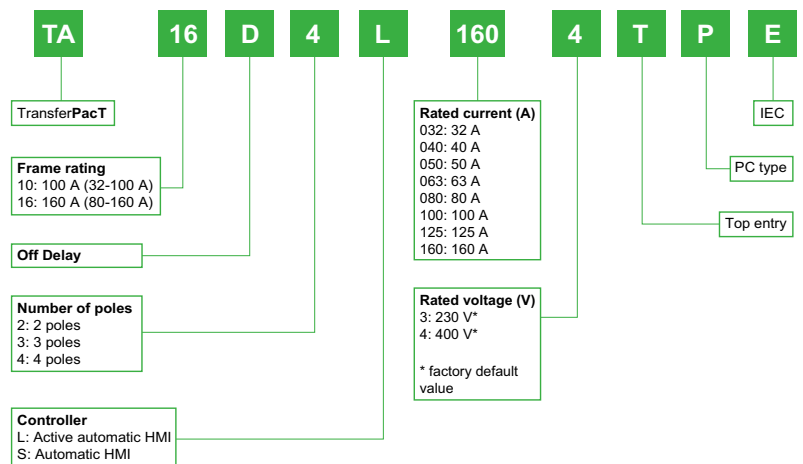

# References of TransferPacT Active Automatic and Automatic 32-160 A



## TransferPacT Active Automatic

TA10D3L0324TPE\_ISO.png



	2P	3P	4P
32A	TA10D2L0323TPE	TA10D3L0324TPE	TA10D4L0324TPE
40A	TA10D2L0403TPE	TA10D3L0404TPE	TA10D4L0404TPE
50A	TA10D2L0503TPE	TA10D3L0504TPE	TA10D4L0504TPE
63A	TA10D2L0633TPE	TA10D3L0634TPE	TA10D4L0634TPE
80A	TA10D2L0803TPE	TA10D3L0804TPE	TA10D4L0804TPE
100A	TA10D2L1003TPE	TA10D3L1004TPE	TA10D4L1004TPE
80A		TA16D3L0804TPE	TA16D4L0804TPE
100A		TA16D3L1004TPE	TA16D4L1004TPE
125A		TA16D3L1254TPE	TA16D4L1254TPE
160A		TA16D3L1604TPE	TA16D4L1604TPE

TA16D4L1004TPE\_ISO.png



## TransferPacT Automatic

TA10D3S0324TPE\_ISO.png



	2P	3P	4P
32A	TA10D2S0323TPE	TA10D3S0324TPE	TA10D4S0324TPE
40A	TA10D2S0403TPE	TA10D3S0404TPE	TA10D4S0404TPE
50A	TA10D2S0503TPE	TA10D3S0504TPE	TA10D4S0504TPE
63A	TA10D2S0633TPE	TA10D3S0634TPE	TA10D4S0634TPE
80A	TA10D2S0803TPE	TA10D3S0804TPE	TA10D4S0804TPE
100A	TA10D2S1003TPE	TA10D3S1004TPE	TA10D4S1004TPE
80A		TA16D3S0804TPE	TA16D4S0804TPE
100A		TA16D3S1004TPE	TA16D4S1004TPE
125A		TA16D3S1254TPE	TA16D4S1254TPE
160A		TA16D3S1604TPE	TA16D4S1604TPE

TA16D4S1004TPE\_ISO.png



## TransferPacT Automatic Function modules

TPCDIO06\_ISO.png



For Active Automatic and Automatic HMI	
Load shedding and Availability warning	TPCDIO05
Transfer inhibit and Remote testing	TPCDIO07
Voluntary Remote control	TPCDIO08
Fire Protection 24 Vdc pulse	TPCDIO10
Fire Protection 24 Vdc constant	TPCDIO11
Fire Protection 230 Vac constant	TPCDIO13
Fire Protection Dry contact	TPCDIO14
Genset start and Alarm	TPCDIO17
For Active Automatic HMI only (* Native equipped for TransferPacT active automatic. no need to order except for renewal or replace)	
BUS Extension and 24 VDC auxiliary supply	TPCDIO15
Modbus RTU (Serial Port)	TPCCOM16

## TransferPacT Automatic spare part

TPCCIF01\_ISO.png



Active Automatic HMI	TPCCIF01
----------------------	----------



TPCCIF02\_ISO.png





Automatic HMI	TPCCIF02
---------------	----------

# References of TransferPacT Active Automatic and Automatic 32-160 A

## TransferPacT Active Automatic External HMI

TPCCIF04_ISO.png		1x	External HMI	<b>TPCCIF04</b>
	TPCOTH18_ISO.eps		1x	HMI Cable 1 m
			HMI Cable 2 m	<b>TRV00820</b>
			HMI Cable 3 m	<b>TRV00830</b>
TPCOTH37_ISO.png		1x	IP54 cover (for outdoor installation)	<b>TPCOTH37</b>

## Connection accessory

TPSISO29_ISO.png			Interphase barrier frame 160 (set of 9)	<b>TPSISO29</b>
			Terminal shield for frame 100 (set of 2)	<b>TPSISO30</b>
			Terminal shield for frame 160 (set of 3)	<b>TPSISO31</b>
TPSCON35_ISO.png			Load extension Bars for frame 100 (set of 4)	<b>TPSCON35</b>
			Load extension Bars for frame 160 (set of 4)	<b>TPSCON36</b>

## Auxiliary contacts

TPSAUX32_ISO.png			OF for Source position	<b>TPSAUX32</b>
			OF for Off position	<b>TPSAUX33</b>

# Circuit breaker/Transfer Switching Equipment coordination

Upstream: Acti9 iC60, C120, NG125

Downstream: TransferPacT Automatic TA10D, TA16D

Ue: ≤415 V AC



Load side	TSE		TA10D					TA16D				
	Rating (A)		32	40	50	63	80	100	80	100	125	160
	Ith (A) 60°C		32	40	50	63	80	100	80	100	125	160
	Icw (kA)		3	3	3	3	3	3	5.5	5.5	5.5	5.5
	Icm (kAp)		15	15	15	15	15	15	20	20	20	20
	Icu											
Supply side	Rating 415 V		TSE conditional short-circuit current and related making capacity:									
<b>Circuit breaker:</b>												
iC60N	≤ 32	10	T	T	T	T	T	T	T	T	T	T
B-C-D Curves	40	10		T	T	T	T	T	T	T	T	T
	50	10			T	T	T	T	T	T	T	T
	63	10				T	T	T	T	T	T	T
iC60H	≤ 32	15	T	T	T	T	T	T	T	T	T	T
B-C-D Curves	40	15		T	T	T	T	T	T	T	T	T
	50	15			T	T	T	T	T	T	T	T
	63	15				T	T	T	T	T	T	T
iC60L	≤ 25	25	T	T	T	T	T	T	T	T	T	T
B-C-D-K-Z Curves	32	20	T	T	T	T	T	T	T	T	T	T
	40	20		T	T	T	T	T	T	T	T	T
	50	15			T	T	T	T	T	T	T	T
	63	15				T	T	T	T	T	T	T
C120N	63	10				T	T	T	T	T	T	T
B-C-D Curves	80	10					T	T	T	T	T	T
1P 240V	100	10								T	T	T
2,3,4P 415V	125	10									T	T
C120H	63	15				T	T	T	T	T	T	T
B-C-D Curves	80	15					T	T	T	T	T	T
1P 240V	100	15								T	T	T
2,3,4P 415V	125	15									T	T
NG125N	≤ 32	25	T	T	T	T	T	T	T	T	T	T
B-C-D Curves	40	25		T	T	T	T	T	T	T	T	T
	50	25			T	T	T	T	T	T	T	T
	63	25				T	T	T	T	T	T	T
	80	25					T	T	T	T	T	T
	100	25								T	T	T
	125	25									T	T
NG125H	≤ 32	36	T	T	T	T	T	T	T	T	T	T
C- Curve	40	36		T	T	T	T	T	T	T	T	T
	50	36			T	T	T	T	T	T	T	T
	63	36				T	T	T	T	T	T	T
	80	36					T	T	T	T	T	T
NG125L	≤ 32	50	T	T	T	T	T	T	T	T	T	T
C- Curve	40	50		T	T	T	T	T	T	T	T	T
	50	50			T	T	T	T	T	T	T	T
	63	50				T	T	T	T	T	T	T
	80	50					T	T	T	T	T	T

- T : Protection of the Transfer Switching Equipment is ensured but combination not very relevant
- T : Transfer Switching Equipment is totally coordinated up to the Icu of the circuit breaker installed on supply side
- 36/75 : Transfer Switching Equipment is protected up to 36 kA rms / 75 kA peak
- : Protection of the Transfer Switching Equipment is not ensured.

# Circuit-breaker/Transfer Switching Equipment coordination

Upstream: ComPacT NSXm

Downstream: TransferPacT Automatic TA10D, TA16D

Ue: ≤440 V AC

Load side		TSE		TA10D				TA16D					
		Rating (A)		32	40	50	63	80	100	80	100	125	160
		lth (A) 60°C		32	40	50	63	80	100	80	100	125	160
		l <sub>cw</sub> (kA)		3	3	3	3	3	3	5.5	5.5	5.5	5.5
		l <sub>cm</sub> (kAp)		15	15	15	15	15	15	20	20	20	20
Supply side		l <sub>cu</sub> (kA)											
Circuit breaker:		415 V	440 V	TSE conditional short-circuit current and related making capacity:									
NSXm E TMD Micrologic 4.1	16	10	l <sub>r</sub> ≤ 32	T	T	T	T	T	T	T	T	T	T
			l <sub>r</sub> ≤ 40		T	T	T	T	T	T	T	T	T
			l <sub>r</sub> ≤ 50			T	T	T	T	T	T	T	T
			l <sub>r</sub> ≤ 63			T	T	T	T	T	T	T	T
			l <sub>r</sub> ≤ 80					T	T	T	T	T	T
			l <sub>r</sub> ≤ 100							T		T	T
			l <sub>r</sub> ≤ 125										T
												T	
NSXm B TMD Micrologic 4.1	25	20	l <sub>r</sub> ≤ 32	T	T	T	T	T	T	T	T	T	T
			l <sub>r</sub> ≤ 40		T	T	T	T	T	T	T	T	T
			l <sub>r</sub> ≤ 50			T	T	T	T	T	T	T	T
			l <sub>r</sub> ≤ 63			T	T	T	T	T	T	T	T
			l <sub>r</sub> ≤ 80					T	T	T	T	T	T
			l <sub>r</sub> ≤ 100							T		T	T
			l <sub>r</sub> ≤ 125										T
												T	
NSXm F TMD Micrologic 4.1	36	35	l <sub>r</sub> ≤ 32	T	T	T	T	T	T	T	T	T	T
			l <sub>r</sub> ≤ 40		T	T	T	T	T	T	T	T	T
			l <sub>r</sub> ≤ 50			T	T	T	T	T	T	T	T
			l <sub>r</sub> ≤ 63			T	T	T	T	T	T	T	T
			l <sub>r</sub> ≤ 80					T	T	T	T	T	T
			l <sub>r</sub> ≤ 100							T		T	T
			l <sub>r</sub> ≤ 125										T
												T	
NSXm N TMD Micrologic 4.1	50	50	l <sub>r</sub> ≤ 32	36/75	36/75	36/75	36/75	36/75	36/75	T	T	T	T
			l <sub>r</sub> ≤ 40		36/75	36/75	36/75	36/75	36/75	T	T	T	T
			l <sub>r</sub> ≤ 50			36/75	36/75	36/75	36/75	T	T	T	T
			l <sub>r</sub> ≤ 63				36/75	36/75	36/75	T	T	T	T
			l <sub>r</sub> ≤ 80					36/75	36/75	T	T	T	T
			l <sub>r</sub> ≤ 100						36/75		T	T	T
			l <sub>r</sub> ≤ 125										T
												T	
NSXm N TMD Micrologic 4.1	70	65	l <sub>r</sub> ≤ 32	36/75	36/75	36/75	36/75	36/75	36/75	T	T	T	T
			l <sub>r</sub> ≤ 40		36/75	36/75	36/75	36/75	36/75	T	T	T	T
			l <sub>r</sub> ≤ 50			36/75	36/75	36/75	36/75	T	T	T	T
			l <sub>r</sub> ≤ 63				36/75	36/75	36/75	T	T	T	T
			l <sub>r</sub> ≤ 80					36/75	36/75	T	T	T	T
			l <sub>r</sub> ≤ 100						36/75		T	T	T
			l <sub>r</sub> ≤ 125										T
												T	

- T : Protection of the Transfer Switching Equipment is ensured but combination not very relevant
- T : Transfer Switching Equipment is totally coordinated up to the l<sub>cu</sub> of the circuit breaker installed on supply side
- 36/75 : Transfer Switching Equipment is protected up to 36 kA rms / 75 kA peak
- : Protection of the Transfer Switching Equipment is not ensured.



# Circuit-breaker/Transfer Switching Equipment coordination

Upstream: ComPacT NSX100-250

Downstream: TransferPacT Automatic TA10D, TA16D

Ue: ≤440 V AC



Load side		TSE		TA10D						TA16D					
		Rating (A)		32	40	50	63	80	100	80	100	125	160		
		lth (A) 60°C		32	40	50	63	80	100	80	100	125	160		
		l <sub>cw</sub> (kA)		3	3	3	3	3	3	5.5	5.5	5.5	5.5		
		l <sub>cm</sub> (kAp)		15	15	15	15	15	15	20	20	20	20		
Supply side		l <sub>cu</sub> (kA)													
Circuit breaker	415 V	440 V	l <sub>r</sub>	TSE conditional short-circuit current and related making capacity:											
	NSX100B NSX160B TMD/TMG/ Micrologic	25	20	l <sub>r</sub> ≤ 32	T	T	T	T	T	T	T	T	T	T	T
l <sub>r</sub> ≤ 40					T	T	T	T	T	T	T	T	T	T	
l <sub>r</sub> ≤ 50						T	T	T	T	T	T	T	T	T	T
l <sub>r</sub> ≤ 63							T	T	T	T	T	T	T	T	T
l <sub>r</sub> ≤ 80										T		T	T	T	T
l <sub>r</sub> ≤ 100											T		T	T	T
l <sub>r</sub> ≤ 125														T	T
NSX250B  TMD/TMG/ Micrologic	25	20	l <sub>r</sub> ≤ 32	T	T	T	T	T	T	T	T	T	T	T	
			l <sub>r</sub> ≤ 40		T	T	T	T	T	T	T	T	T	T	
			l <sub>r</sub> ≤ 50			T	T	T	T	T	T	T	T	T	T
			l <sub>r</sub> ≤ 63				T	T	T	T	T	T	T	T	T
			l <sub>r</sub> ≤ 80							T		T	T	T	T
			l <sub>r</sub> ≤ 100								T		T	T	T
			l <sub>r</sub> ≤ 125											T	T
NSX100F NSX160F TMD/TMG/ Micrologic	36	35	l <sub>r</sub> ≤ 32	T	T	T	T	T	T	T	T	T	T	T	
			l <sub>r</sub> ≤ 40		T	T	T	T	T	T	T	T	T	T	
			l <sub>r</sub> ≤ 50			T	T	T	T	T	T	T	T	T	T
			l <sub>r</sub> ≤ 63				T	T	T	T	T	T	T	T	T
			l <sub>r</sub> ≤ 80							T		T	T	T	T
			l <sub>r</sub> ≤ 100								T		T	T	T
			l <sub>r</sub> ≤ 125											T	T
NSX250F  TMD/TMG/ Micrologic	36	35	l <sub>r</sub> ≤ 32	25/52	25/52	25/52	25/52	25/52	25/52	25/52	T	T	T	T	
			l <sub>r</sub> ≤ 40		25/52	25/52	25/52	25/52	25/52	25/52	T	T	T	T	
			l <sub>r</sub> ≤ 50			25/52	25/52	25/52	25/52	25/52	T	T	T	T	
			l <sub>r</sub> ≤ 63				25/52	25/52	25/52	25/52	T	T	T	T	
			l <sub>r</sub> ≤ 80					25/52	25/52	25/52	T	T	T	T	
			l <sub>r</sub> ≤ 100						25/52	25/52		T	T	T	
			l <sub>r</sub> ≤ 125										T	T	
NSX100N/H NSX160N/H TMD/TMG/ Micrologic	50/ 70	50/ 65	l <sub>r</sub> ≤ 32	36/75	36/75	36/75	36/75	36/75	36/75	36/75	T	T	T	T	
			l <sub>r</sub> ≤ 40		36/75	36/75	36/75	36/75	36/75	36/75	T	T	T	T	
			l <sub>r</sub> ≤ 50			36/75	36/75	36/75	36/75	36/75	T	T	T	T	
			l <sub>r</sub> ≤ 63				36/75	36/75	36/75	36/75	T	T	T	T	
			l <sub>r</sub> ≤ 80					36/75	36/75	36/75		T	T	T	
			l <sub>r</sub> ≤ 100							36/75		T	T	T	
			l <sub>r</sub> ≤ 125										T	T	
NSX250N/H  TMD/TMG/ Micrologic	50/ 70	50/ 65	l <sub>r</sub> ≤ 32	25/52	25/52	25/52					T	T	T	T	
			l <sub>r</sub> ≤ 40		25/52	25/52	25/52	25/52	25/52	25/52	T	T	T	T	
			l <sub>r</sub> ≤ 50			25/52	25/52	25/52	25/52	25/52	T	T	T	T	
			l <sub>r</sub> ≤ 63				25/52	25/52	25/52	25/52	T	T	T	T	
			l <sub>r</sub> ≤ 80					25/52	25/52	25/52		T	T	T	
			l <sub>r</sub> ≤ 100							25/52		T	T	T	
			l <sub>r</sub> ≤ 125										T	T	
l <sub>r</sub> ≤ 160											T				

# Circuit-breaker/Transfer Switching Equipment coordination

Upstream: ComPacT NSX100-250

Downstream: TransferPacT Automatic TA10D, TA16D

Ue: ≤440 V AC

Load side			TSE		TA10D						TA16D			
			Rating (A)		32	40	50	63	80	100	80	100	125	160
			Ith (A) 60°C		32	40	50	63	80	100	80	100	125	160
			Icw (kA)		3	3	3	3	3	3	5.5	5.5	5.5	5.5
			Icm(kAp)		15	15	15	15	15	15	20	20	20	20
Supply side			TSE conditional short-circuit current and related making capacity:											
Circuit breaker	415V	440V	Ir											
	NSX100S/L/R NSX160S/L/R TMD/TMG/ Micrologic	100/ 150/ 200	90/ 150/ 200	Ir ≤ 32	36/75	36/75	36/75	36/75	36/75	36/75	36/75	65/143	65/143	65/143
Ir ≤ 40					36/75	36/75	36/75	36/75	36/75	36/75	65/143	65/143	65/143	65/143
Ir ≤ 50						36/75	36/75	36/75	36/75	36/75	65/143	65/143	65/143	65/143
Ir ≤ 63							36/75	36/75	36/75	65/143	65/143	65/143	65/143	
Ir ≤ 80								36/75	36/75	65/143	65/143	65/143	65/143	
Ir ≤ 100									36/75	65/143	65/143	65/143	65/143	
Ir ≤ 125											65/143	65/143	65/143	
Ir ≤ 160													65/143	
NSX250S/L/R  TMD/TMG/ Micrologic	100/ 150/ 200	90/ 150/ 200	Ir ≤ 32	25/52	25/52	25/52	25/52	25/52	25/52	25/52	65/143	65/143	65/143	65/143
			Ir ≤ 40		25/52	25/52	25/52	25/52	25/52	25/52	65/143	65/143	65/143	65/143
			Ir ≤ 50			25/52	25/52	25/52	25/52	25/52	65/143	65/143	65/143	65/143
			Ir ≤ 63				25/52	25/52	25/52	65/143	65/143	65/143	65/143	
			Ir ≤ 80					25/52	25/52	65/143	65/143	65/143	65/143	
			Ir ≤ 100						25/52	65/143	65/143	65/143	65/143	
			Ir ≤ 125								65/143	65/143	65/143	
			Ir ≤ 160										65/143	

**T** : Protection of the Transfer Switching Equipment is ensured but combination not very relevant

**T** : Transfer Switching Equipment is totally coordinated up to the Icu of the circuit breaker installed on supply side

**36/75** : Transfer Switching Equipment is protected up to 36 kA rms / 75 kA peak

: Protection of the Transfer Switching Equipment / circuit breaker is not ensured.

# Fuses/Transfer Switching Equipment coordination

Upstream: gG Fuse

Downstream: TransferPacT Automatic TA10D, TA16D

Ue: ≤440 V AC



Load side	TSE	TA10D						TA16D				
		Rating (A)	32	40	50	63	80	100	80	100	125	160
Supply side	Rating (A)	32	40	50	63	80	100	80	100	125	160	
	Ith (A) 60°C	32	40	50	63	80	100	80	100	125	160	
Fuse type	Rating (A)	3	3	3	3	3	3	5.5	5.5	5.5	5.5	
gG fuse link without overload relay	Rating (A)	15	15	15	15	15	15	20	20	20	20	
	25	T	T	T	T	T	T	T	T	T	T	
	32		T	T	T	T	T	T	T	T	T	
	40			T	T	T	T	T	T	T	T	
	50				T	T	T	T	T	T	T	
	63						T		T	T	T	
	80						T		T	T	T	
	100									T	T	
	125										T	
gG fuse link with overload relay	160										T	
	≤ 50	T	T	T	T	T	T	T	T	T	T	
	63	T	T	T	T	T	T	T	T	T	T	
	80		T	T	T	T	T	T	T	T	T	
	100			T	T	T	T	T	T	T	T	
	125				80/176	80/176	80/176	80/176	T	T	T	T
	160					36/75	36/75	36/75	50/105	50/105	50/105	50/105
200								36/75	36/75	36/75		

**T** : Protection of the Transfer Switching Equipment is ensured but combination not very relevant

**T** : Transfer Switching Equipment is totally coordinated up to the Icu of the circuit breaker installed on supply side

**36/75** : Transfer Switching Equipment is protected up to 36 kA rms / 75 kA peak

: Protection of the Transfer Switching Equipment is not ensured.

Important Notice : Current limitation characteristics can be significantly different from one manufacturer to another This table can not dispense to check selected fuse characteristics



## TransferPacT FXM

### Contents

Switching devices .....	B-2
TransferPacT FXM100 to 630 .....	B-4
MTSE/Manual source-changeover systems .....	B-8
References of TransferPacT FXM.....	B-9
Order form for manual source-changeover systems .....	B-10



# Switching devices

## M

### Complete Source-changeover Assembly

(or MTSE: Manual Transfer Switching Equipment)

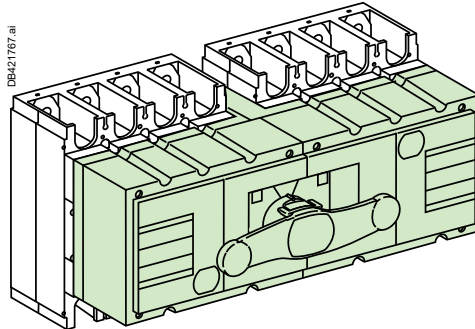

#### Definition of Class PC

Transfer switch equipment based on mechanical switching devices, that do not need electrical power to hold the main contacts open or closed and capable of making, carrying, and breaking currents under normal circuit conditions including operating overload conditions, and making and withstanding short-circuit currents.

#### Definition of Derived TSE

TSE based on switching devices that have certain tests required for compliance with IEC 60947-6-1 as defined in Table 9, covered by IEC 60947-3 for Class PC, IEC 60947-2 or IEC 60947-6-2 for Class CB, or IEC 60947-4-1 for Class CC

#### Definition of MTSE (Manual Transfer Switching Equipment)

manually operated transfer switching equipment, transfer switching equipment operated manually and non-electrically.

#### TransferPacT FXM is a class PC, derived MTSE (complete source-changeover assembly)

These assemblies provide an easy way to implement source changeover functions with:

- A single 3-position rotary handle that controls the two switch-disconnectors (Normal source ON, OFF, Replacement source ON)
- A smaller size, taking up less room in the switchboard.

A complete source changeover assembly can be ordered with a single catalog number.

# Switching devices

## Complete source changeover assembly

	TransferPacT FXM100 to 250			TransferPacT FXM320 to 630		
	Normal ON	OFF	Replacement ON	Normal ON	OFF	Replacement ON
Locking by padlocks	<input type="radio"/>	<input checked="" type="radio"/>	<input type="radio"/>	<input type="radio"/>	<input checked="" type="radio"/>	<input type="radio"/>
Locking by keylock	-	<input checked="" type="radio"/>	-	-	<input checked="" type="radio"/>	-
Door locking <sup>[1]</sup>	<input checked="" type="radio"/>	-	<input checked="" type="radio"/>	<input checked="" type="radio"/>	-	<input checked="" type="radio"/>
Door lock defeat <sup>[1]</sup>	<input checked="" type="radio"/> [2]	-	<input checked="" type="radio"/> [2]	<input checked="" type="radio"/> [2]	-	<input checked="" type="radio"/> [2]
Door locking device padlocked <sup>[1]</sup>	-	<input checked="" type="radio"/>	-	-	<input checked="" type="radio"/>	-
Lead-sealable handle	<input type="radio"/>	<input checked="" type="radio"/>	<input type="radio"/>	<input type="radio"/>	<input checked="" type="radio"/>	<input type="radio"/>

Standard.  By simple modification of the standard rotary handle.

[1] With extended rotary control. [2] Using a special tool.



# TransferPacT FXM100 to 630

## (complete source-changeover assembly)

3114\_image\_2.eps



Complete source-changeover assembly.

PB110866\_60.eps

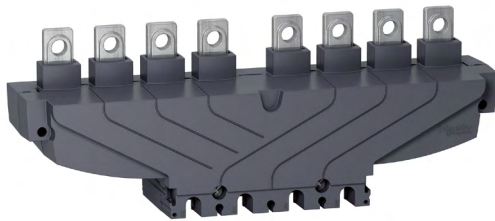

Coupling accessory.

### FXM

Number of poles

#### Electrical characteristics as defined by IEC 60947-1 / 60947-6-1 and EN 60947-1 / 60947-6-1

Conventional thermal current (A)	<b>I<sub>th</sub></b>	at 60 °C
Conventional thermal current in enclosure	<b>I<sub>the</sub></b>	at 60 °C
Rated insulation level (V)	<b>U<sub>i</sub></b>	AC 50/60 Hz
Impulse-withstand voltage (kV)	<b>U<sub>imp</sub></b>	
Rated operational voltage (V)	<b>U<sub>e</sub></b>	AC 50/60 Hz DC
Rated operational voltage AC20 and DC20 (V)		AC 50/60 Hz
Rated operational current (A)	<b>I<sub>e</sub></b>	<b>Electrical AC 50/60 Hz</b> 220-240 V 380-415 V 440-480 V 500-525 V 660-690 V <b>Electrical DC</b> 125 V (2P in series) 250 V (4P in series)

Rated duties

Uninterrupted duty

Intermittent duty

Short-circuit making capacity (kA peak)	<b>I<sub>cm</sub></b>	Min. (switch-disconnector alone)
		Max. (with upstream protection circuit breaker)

Short-time withstand current (A rms)

**I<sub>cw</sub>**1 s  
3 s  
20 s  
30 s

Suitability for isolation

Durability (category A) (O - C-O cycles)

Mechanical

<b>Electrical AC 50/60 Hz</b>
440 V
500 V
690 V

**Electrical DC**

250 V

Positive contact indication

Visible break

Emergency-off switch-disconnector

Degree of pollution

#### Upstream protection

See the "Complementary technical information".



# TransferPacT FXM100 to 630 (complete source-changeover assembly)

B

FXM100		FXM160		FXM200		FXM250		FXM320		FXM400		FXM500		FXM630	
3-4		3-4		3-4		3-4		3-4		3-4		3-4		3-4	
100		160		200		250		320		400		500		630	
100		160		200		250		320		400		500		630	
750		750		750		750		750		750		750		750	
8		8		8		8		8		8		8		8	
690		690		690		690		690		690		690		690	
250		250		250		250		250		250		250		250	
750		750		750		750		750		750		750		750	
<b>AC22A</b>	<b>AC23A</b>	<b>AC22A</b>	<b>AC23A</b>	<b>AC22A</b>	<b>AC23A</b>	<b>AC22A</b>	<b>AC23A</b>	<b>AC22A</b>	<b>AC23A</b>	<b>AC22A</b>	<b>AC23A</b>	<b>AC22A</b>	<b>AC23A</b>	<b>AC22A</b>	<b>AC23A</b>
100	100	160	160	200	200	250	250	320	320	400	400	500	500	630	630
100	100	160	160	200	200	250	250	320	320	400	400	500	500	630	630
100	100	160	160	200	200	250	250	320	320	400	400	500	500	630	630
100	100	160	160	200	200	250	250	320	320	400	400	500	500	630	630
<b>DC22A</b>	<b>DC23A</b>	<b>DC22A</b>	<b>DC23A</b>	<b>DC22A</b>	<b>DC23A</b>	<b>DC22A</b>	<b>DC23A</b>	<b>DC22A</b>	<b>DC23A</b>	<b>DC22A</b>	<b>DC23A</b>	<b>DC22A</b>	<b>DC23A</b>	<b>DC22A</b>	<b>DC23A</b>
100	100	160	160	200	200	250	250	320	320	400	400	500	500	550	550
100	100	160	160	200	200	250	250	320	320	400	400	500	500	550	630
100	100	160	160	200	200	250	250	320	320	400	400	500	500	550	630
○		○		○		○		○		○		○		○	
Class 120 - 60 %		Class 120 - 60 %		Class 120 - 60 %		Class 120 - 60 %		Class 120 - 60 %		Class 120 - 60 %		Class 120 - 60 %		Class 120 - 60 %	
30		30		30		30		50		50		50		50	
330		330		330		330		330		330		330		330	
8500		8500		8500		8500		20000		20000		20000		20000	
4900		4900		4900		4900		11500		11500		11500		11500	
2200		2200		2200		2200		4900		4900		4900		4900	
1800		1800		1800		1800		4000		4000		4000		4000	
○		○		○		○		○		○		○		○	
15000		15000		15000		15000		10000		10000		10000		10000	
<b>AC22A</b>	<b>AC23A</b>	<b>AC22A</b>	<b>AC23A</b>	<b>AC22A</b>	<b>AC23A</b>	<b>AC22A</b>	<b>AC23A</b>	<b>AC22A</b>	<b>AC23A</b>	<b>AC22A</b>	<b>AC23A</b>	<b>AC22A</b>	<b>AC23A</b>	<b>AC22A</b>	<b>AC23A</b>
1500	1500	1500	1500	1500	1500	1500	1500	1500	1500	1500	1500	1500	1500	1500	1500
1500	1500	1500	1500	1500	1500	1500	1500	1500	1500	1500	1500	1500	1500	1500	1500
1500	1500	1500	1500	1500	1500	1500	1500	1500	1500	1500	1500	1500	1500	1500	1500
<b>DC22A</b>	<b>DC23A</b>	<b>DC22A</b>	<b>DC23A</b>	<b>DC22A</b>	<b>DC23A</b>	<b>DC22A</b>	<b>DC23A</b>	<b>DC23A</b>	<b>DC23B</b>	<b>DC23A</b>	<b>DC23B</b>	<b>DC23A</b>	<b>DC23B</b>	<b>DC23A</b>	<b>DC23B</b>
1500	1500	1500	1500	1500	1500	1500	1500	1000	-	1000	-	1000	-	1000	200
○		○		○		○		○		○		○		○	
-	-	-	-	-	-	-	-	-	-	-	-	-	-	-	-
-	-	-	-	-	-	-	-	-	-	-	-	-	-	-	-
3	3	3	3	3	3	3	3	3	3	3	3	3	3	3	3
-	-	-	-	-	-	-	-	-	-	-	-	-	-	-	-

# TransferPacT FXM100 to 630

## (complete source-changeover assembly)

### FXM

#### Installation

Fixed, front connection

Fixed, rear connection

On symmetrical rails

On a backplate

#### Connection

By cables To bare cable connectors

By cables with lugs Directly to terminals

To spreaders

To vertical-connection adapters via cable-lug adapters

Flat-facing bars Directly to terminals

To spreaders

Edgewise bars To vertical-connection adapters

#### Indication and measurement auxiliaries

Auxiliary contacts

Voltage-presence indicator

Current-transformer module

Ammeter module

#### Control, locking and interlocking

Control Direct front rotary handle

Extended front rotary handle

Direct lateral rotary handle

Extended lateral rotary handle

Interlocking By keylock

Mechanical

Complete source-changeover assembly

Operating torque (Nm) (typical value for 3-4 poles with front handle)

#### Installation and connection accessories

Bare cable connectors

Rear connectors

Terminal extensions

Spreaders

One-piece spreader

Terminal shrouds

Terminal shields

Interphase-barrier

Front panel escutcheons

Coupling accessories(downstream, outgoing pitch for FXM100-250 is 35mm, FXM 320-630 is 45mm)

Tightening torque for electrical connections (Nm)

#### Dimensions and weights

Overall dimensions H x W x D (mm) 3 poles

4 poles

Approximate weight (kg) 3 poles

4 poles



# MTSE/Manual source-changeover systems

## TransferPacT FXM

Class PC

### Complete manual source-changeover assembly

TransferPacT FXM with direct rotary handle

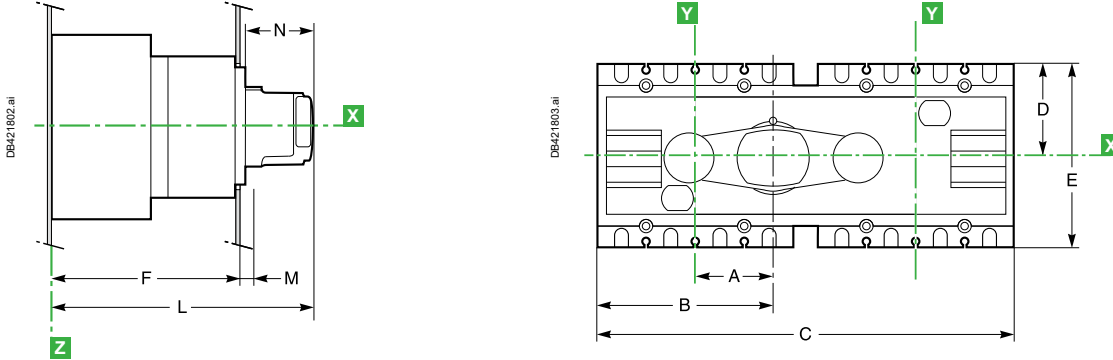

#### Front-panel cutout

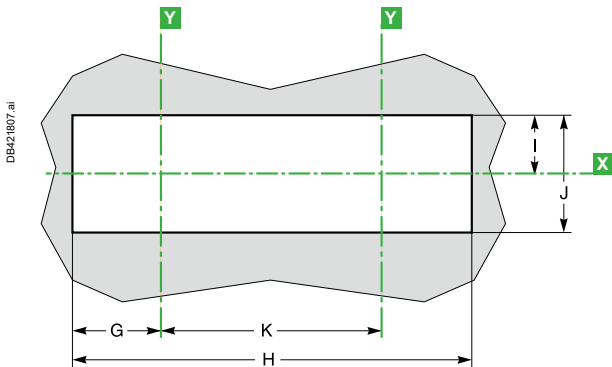

#### Dimensions (mm)

Type	A	B	C	D	E	F	G	H	I	J	K	L	M	N
FXM 100 to 250 A	60.4	130.4	296	68	136	131	61.8	279.3	42	84	156	186.5	5.5	50
FXM 320 to 630 A	82.5	175	395	102.5	205	155	87	383.7	64	128	210	213	8	50

### TransferPacT FXM with extended handle

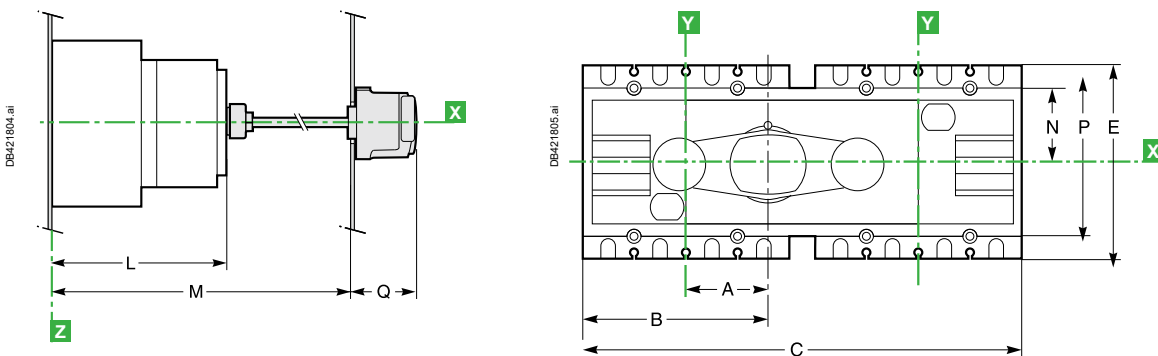

#### Dimensions (mm)

Type	A	B	C	E	K	L	M	N
FXM 100 to 250 A	60.4	130.4	295	136	156	138.5	631	50
FXM 320 to 630 A	82.5	175	395	205	210	162.5	658	75

#### Dimensions (mm)

Type	P	Mmax	Mmin	Q
FXM 100 to 250 A	100	567.5	195	64
FXM 320 to 630 A	150	593	220.5	64

**Note:** lines X and Y indicate the axes of symmetry of the switch-disconnector. Reference plane Z corresponds to the back of the switch-disconnector.

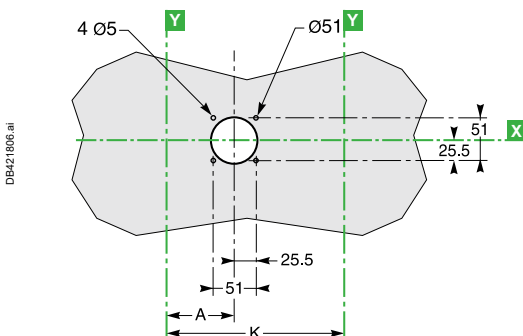

# References of TransferPacT FXM

B

## TransferPacT FXM (complete source-changeover assembly)

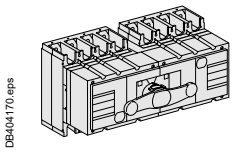

	3P	4P
FXM100	31140	31141
FXM160	31144	31145
FXM200	31142	31143
FXM250	31146	31147
FXM320	31148	31149
FXM400	31150	31151
FXM500	31152	31153
FXM630	31154	31155

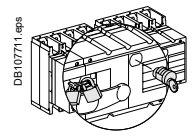

<b>Locking for TransferPacT FXM</b>		
Handle locking by 1 to 3 padlocks (in OFF position)		<b>Built in</b>
By keylock	Keylocking device	<b>31097</b>
	+ Ronis 1351B.500 keylock	<b>41940</b>
	or + Profalux KS5 B24 D4Z keylock	<b>42888</b>

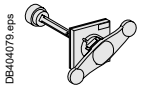

<b>Rotary handle</b>		
Extended front control for complete source changeover assembly		<b>31055</b>

## Connection accessories

### Downstream coupling accessories

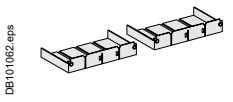

<b>Short terminal shields (1 pair) + "Normal" source/"Replacement" source</b>		
	INS250/INS250	<b>3/4P</b>
	INS320 to INS630/INS320 to INS630	<b>LV429359</b>
		<b>LV432620</b>

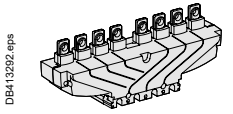

<b>Long terminal shields (1 piece)</b>		
INS250	Long terminal shield	<b>LV429518</b>
INS320 to INS630	Long terminal shield, 45 mm (1 piece)	<b>LV432594</b>
	Long terminal shield for spreaders, 52.5 mm (1 piece)	<b>LV432596</b>

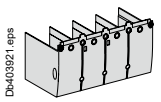

# Order form for manual source-changeover systems

To indicate your choices, check the applicable square boxes  and enter the appropriate information in the rectangles .

Complete source-changeover assembly			
INS250-100 A	<input type="checkbox"/>	INS250-160 A	<input type="checkbox"/>
INS250-200 A	<input type="checkbox"/>	INS250-250 A	<input type="checkbox"/>
INS320	<input type="checkbox"/>	INS400	<input type="checkbox"/>
INS500	<input type="checkbox"/>	INS630	<input type="checkbox"/>

## ATS, RTS and MTS based on ComPacT and MasterPacT range

### Contents

Manual, Remote and Automatic Transfer Switch .....	C-2
Switching devices .....	C-4
TransferPacT .....	C-10
TransferPacT controllers.....	C-18
Manual source-changeover systems .....	C-28
Source-changeover systems.....	C-37
Standard configurations .....	C-45
Remote-operated source-changeover systems .....	C-47
Source-changeover systems with UA controllers .....	C-59
Source-changeover systems with BA controllers.....	C-61
Remote-operated source-changeover systems.....	C-62
References of source-changeover systems for 2 devices ...	C-71
Order form for source-changeover systems for 2 devices ....	C-77

# Manual, Remote and Automatic Transfer Switch

Schneider Electric offers source change-over systems based on ComPacT and MasterPacT devices. They are made of up to 3 circuit breakers or switch-disconnectors linked by an electrical interlocking system that may have different configurations. Moreover, a mechanical interlocking system must be added to protect against electrical malfunctions or incorrect manual operations. In addition, a controller can be used for automatically control the source transfer. The following pages present the different solutions for mechanical and electrical interlocking and associated controllers.

## M

### Manual source-changeover system (or MTSE: Manual Transfer Switching Equipment)

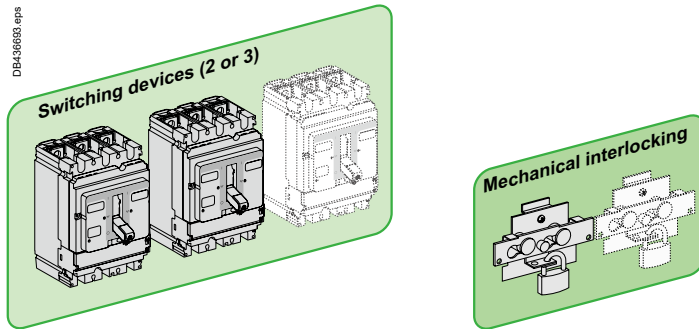

## R/A

### Remote-operated source-changeover system (or RTSE: Remote Transfer Switching Equipment)

### Automatic source-changeover system (or ATSE: Automatic Transfer Switching Equipment)

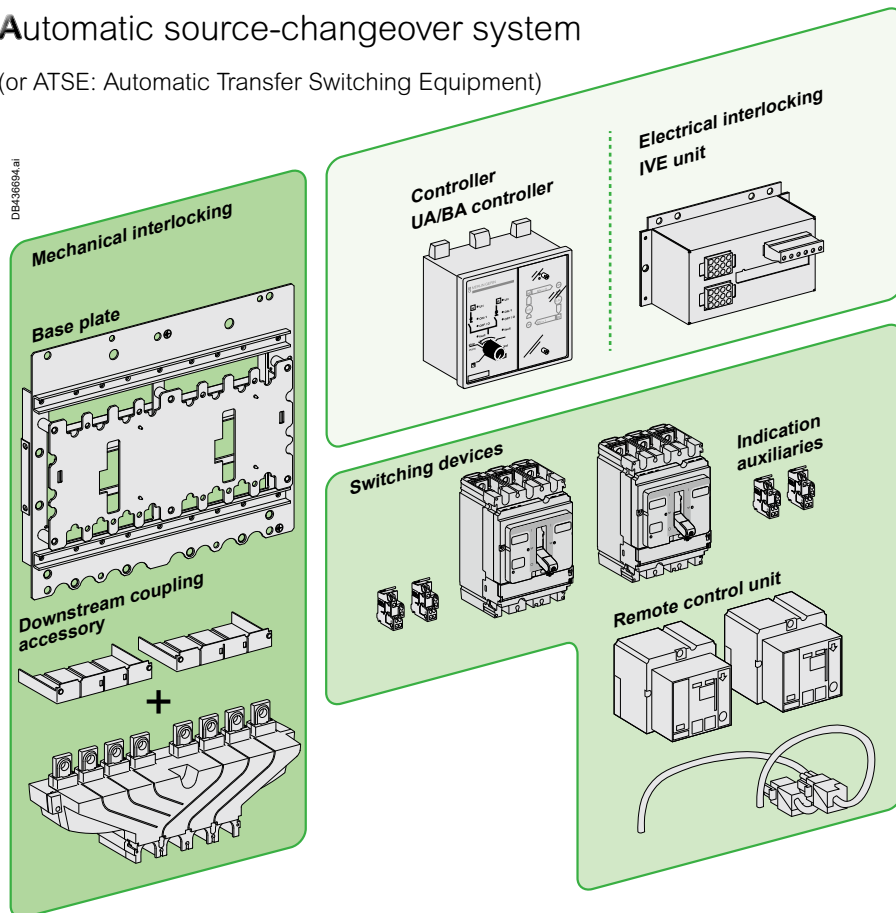



# Manual, Remote and Automatic Transfer Switch

## Switching devices

	Class PC	Class CB
ComPacT INS/INV	C-4	-
ComPacT NSX	C-5	C-8
ComPacT NS	C-5	C-9
MasterPacT MTZ1	C-5	C-9
MasterPacT MTZ2/MTZ3	C-5	C-9

## Mechanical interlocking

Mechanical interlocks	C-10
Keylocks with captive keys	C-12
Cables or connecting rods	C-15

## TransferPacT

### Electrical interlocking

Electrical interlocking	
IVE unit + base plate	C-16
IVE unit, Operating sequences	C-17

### TransferPacT controller

With automatic controller	
Controller selection	C-18
Controller installation	C-19
BA controller	C-20
BA controller, Operating sequences	C-21
UA controller	C-22
UA controller, Operating sequences, Forced operation mode	C-23
UA controller, Operating sequences, Special-tariff mode	C-24
UA controller, Operating sequences, Test mode and automatic operation	C-25
UA/BA controller, Operating sequences	C-26

## Information

IEC 60947-6-1 applies to transfer switching equipment (TSE) to be used in power systems for transferring a load supply between a normal and an alternate source (other power supply or generator).

TSE is classified according to

- The method of controlling the transfer
  - Manually transfer switching equipment (MTSE)
  - Automatic transfer switching equipment (ATSE)
- their short circuit capability
  - Class PC: TSE that is capable of making and withstanding, but not intended for breaking short-circuit currents. Switch and switch-disconnectors are the most useful products used.
  - Class CB: TSE that is capable of making, withstanding, it's intended for breaking short-circuit currents and is provided with over-current releases. Circuit breakers (air circuit breaker or moulded-case circuit breaker) are the most useful products used.

# Switching devices

## Class PC

Range	ComPacT INS	ComPacT INS/INV
Types of devices	INS40 to INS80 INS100 to INS160	INS250 to INS630 INV100 to INV630
Mixing possibilities	All devices, not possible with a complete assembly source-changeover	All devices, not possible with a complete assembly source-changeover
<b>Electrical characteristics</b>		
Current rating	40 to 160 A	100 to 630 A
Insulating voltage $U_i$ (V AC)	750	800
Rated operational voltage		
Positive break indication	■	■
Number of poles (N and R devices must have the same number of poles)	3, 4	3, 4
Operating temperature	-25 °C and +70 °C	-25 °C and +70 °C
<b>Additional indication and control auxiliaries</b>		
Indication contacts	OF	OF
Voltage releases		
MX shunt		
MN undervoltage		
Voltage presence indicator	■	■
Voltage transformer		
Ammeter module	■	■
Insulation monitoring module		
<b>Installation and connection</b>		
Fixed front connected	■	■
Fixed rear connected	■	■
Withdrawable, plug-in or drawout		
<b>Installation and connection accessories</b>		
Downstream coupling accessory		■
Bare-cable connectors	■	■
Terminal extensions	■	■
Terminal shields and inter-phase barriers	■	■
Front panel escutcheons		■
Locking		
by padlock	■	■
by keylock	■	■

# Switching devices

## Class PC

Range	ComPacT NSX		ComPacT NS	MasterPacT	
Types of devices	NSX100 to NSX250	NSX400 to NSX630	NS630b to NS1600	MTZ1 06 to 16	MTZ2 08 to 40 MTZ3 40 to 63
Mixing possibilities	all devices	all devices	all devices	all mixing possibilities	all mixing possibilities
	NSX100NA to NSX250NA	NSX100NA to NSX630NA	NS630bNA to NSX1600NA	(fixed, drawout or fixed + drawout) HA	(fixed, drawout or fixed + drawout) NA/HA/HA10
	fixed/fixed or plug-in/plug-in	fixed/fixed or plug-in/plug-in	fixed/fixed or plug-in/plug-in		

### Electrical characteristics

Current rating	15 to 250 A	15 to 630 A	250 to 1600 A	600 to 1600 A	800 to 6300 A
Insulating voltage $U_i$ (V AC)	750	750	750	1000	1000
Rated operational voltage					
Positive break indication	■	■		■	■
Number of poles (N and R devices must have the same number of poles)	3, 4	3, 4	3, 4	3, 4	3, 4
Operating temperature	-25 °C to +70 °C (50 °C for 440 V - 60 Hz)		-25 °C to +70 °C (50 °C for 440 V - 60 Hz)	-25 °C to +70 °C	

### Control characteristics

Control voltage	AC	48 V - 50 Hz 110/130, 220/240, 380/440 V - 50/60 Hz	48 V - 50 Hz 110/130, 220/240, 380/440 V - 50/60 Hz		48 to 415 V - 50/60 Hz 440 V - 60 Hz	
	DC	24-250 V	24-250 V	24-250 V	24-250 V	24-250 V
Maximum consumption	AC	500 VA	500 VA	180 VA	180 VA	180 VA
	DC	500 W	500 W	180 W	180 W	180 W
Minimum switching time		800 ms	800 ms	800 ms	800 ms	800 ms

### Protection and measurement

Earth-leakage protection	by Vigi module	■	■			
	by control unit			■	■	■
	by add-on VigiPact relay	■	■	■	■	■
Current measurements				■	■	■
Voltage, frequency, power measurements, etc.				■	■	■

### Additional indication and control auxiliaries

Indication contacts	OF + SDE (+ SDV)	3 OF + SDE (+ SDV)	2 OF + SDE	2 OF + SDE	2 OF + SDE
Voltage releases	MX shunt	■	■	■	■
	MN undervoltage	■	■	■	■
Voltage presence indicator	■	■			
Voltage transformer	■	■			
Ammeter module	■	■			
Insulation monitoring module	■	■			

### Installation and connection

Fixed front connected				■	■
Fixed rear connected	■ (long rear connections)	■ (long rear connections)	■ (vertical or horizontal)	■ (vertical or horizontal)	■ (vertical or horizontal)
Withdrawable, plug-in or drawout	■ (plug-in on base)	■ (plug-in on base)	■ (drawout)	■ (drawout)	■ (drawout)

### Installation and connection accessories

Downstream coupling accessory	■	■			
Bare-cable connectors	■	■	■		
Terminal extensions	■	■			
Terminal shields and inter-phase barriers		■	■		
Front panel escutcheons	■	■	■	■	■
Locking	by padlock	■	■	■	■
	by keylock	■	■	■	■



# Switching devices

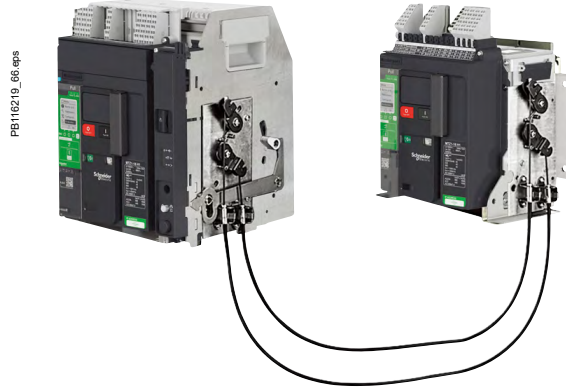

ComPacT NSX and ComPacT NS class PC and CB	NSX100 to 250		NSX400 to NSX630		NS630b to NS1600	
Number of poles	3, 4		3, 4		3, 4	
Rated current In (A)	100 to 250		400 to 630		630 to 1600	
Mechanical durability (O <sub>N</sub> -C <sub>R</sub> -O <sub>R</sub> -C <sub>N</sub> cycles)	20000 - 40000 - 50000		15000		8000	
Electrical durability at In (O <sub>N</sub> -C <sub>R</sub> -O <sub>R</sub> -C <sub>N</sub> cycles) for ≤ 440 V and 480 V NEMA <sup>[2]</sup>	10000 - 20000 - 30000		4000 - 6000		2000	
Electrical durability at In (O <sub>N</sub> -C <sub>R</sub> -O <sub>R</sub> -C <sub>N</sub> cycles) for U = 500 V to 690 V <sup>[2]</sup>	5000 - 7500 - 10000		2000 - 3000		1500	
MasterPacT class PC and CB	MTZ1 06 to 10	MTZ1 12 to 16	MTZ2 08 to 16	MTZ2 20	MTZ2 25 to 40	MTZ3 40 to 63
Number of poles	3, 4	3, 4	3, 4	3, 4	3, 4	3, 4
Rated current In (A)	630 to 1600	1250 to 1600	800 to 1600	2000	2500 to 4000	4000 to 6300
Mechanical durability <sup>[1]</sup> (O <sub>N</sub> -C <sub>R</sub> -O <sub>R</sub> -C <sub>N</sub> cycles)	8000	8000	10000	10000	10000	5000
Electrical durability at In (O <sub>N</sub> -C <sub>R</sub> -O <sub>R</sub> -C <sub>N</sub> cycles) <sup>[1]</sup> for ≤ 440 V and 480 V NEMA <sup>[2]</sup>	6000	6000 MTZ1 16: 3000	10000	8000	5000	1500
Electrical durability at In (O <sub>N</sub> -C <sub>R</sub> -O <sub>R</sub> -C <sub>N</sub> cycles) <sup>[1]</sup> for U = 500 V to 690 V <sup>[2]</sup>	3000	2000 MTZ1 16: 1000	10000	6000	2500	1500

[1] Mechanical and electrical durability not applicable to MasterPacT H3 and L versions.

[2] Electrical durability tests carried out with a power factor of 0.8 as per IEC 947-2.

**Note:**

ON: opening of N source

CR: closing of R source

OR: opening of R source

CN: closing of N source



# Switching devices

## Class CB

Range		ComPacT NSX	
Types of devices		NSX100 to NSX250	NSX400 to NSX630
Mixing possibilities		all devices NSX100 to NSX250 N/H/L fixed/fixed or plug-in/plug-in	all devices NSX100 to NSX630 N/H/L fixed/fixed or plug-in/plug-in
<b>Electrical characteristics</b>			
Current rating		15 to 250 A	15 to 630 A
Insulating voltage $U_i$ (V AC)		750	750
Rated operational voltage			
Positive break indication		■	■
Number of poles (N and R devices must have the same number of poles)		3, 4	3, 4
Operating temperature		-25 °C to +70 °C (50 °C for 440 V - 60 Hz)	
<b>Motor mechanism</b>			
Control voltage	AC	48 V - 50 Hz 110/130, 220/240, 380/440 V - 50/60 Hz	48 V - 50 Hz 110/130, 220/240, 380/440 V - 50/60 Hz
	DC	24-250 V	24-250 V
Maximum consumption	AC	500 VA	500 VA
	DC	500 W	500 W
Minimum switching time		800 ms	800 ms
<b>Protection and measurement</b>			
Earth-leakage protection	by Vigi module	■	■
	by control unit		
	by add-on VigiPact relay	■	■
Current measurements			
Voltage, frequency, power measurements, etc.			
<b>Additional indication and control auxiliaries</b>			
Indication contacts		OF + SDE (+ SDV)	3 OF + SDE (+ SDV)
Voltage releases	MX shunt	■	■
	MN undervoltage	■	■
Voltage presence indicator		■	■
Voltage transformer		■	■
Ammeter module		■	■
Insulation monitoring module		■	■
<b>Installation and connection</b>			
Fixed front connected			
Fixed rear connected		■ (long rear connections)	■ (long rear connections)
Withdrawable, plug-in or drawout		■ (plug-in on base)	■ (plug-in on base)
<b>Installation and connection accessories</b>			
Downstream coupling accessory		■	■
Bare-cable connectors		■	■
Terminal extensions		■	■
Terminal shields and inter-phase barriers		■	■
Front panel escutcheons		■	■
Locking	by padlock	■	■
	by keylock	■	■
<b>ComPacT NSX</b>			
		<b>NSX100-250</b>	<b>NSX400 to NSX630</b>
Rated current $I_n$ (A)		100 to 250	400 to 630
Mechanical durability ( $O_N-C_R-O_R-C_N$ cycles) <sup>[1]</sup>		20000 - 40000 - 50000	15000
Electrical durability at $I_n$ ( $O_N-C_R-O_R-C_N$ cycles) <sup>[1]</sup> for $\leq 440$ V and 480 V NEMA <sup>[2]</sup>		10000 - 20000 - 30000	4000 - 6000
Electrical durability at $I_n$ ( $O_N-C_R-O_R-C_N$ cycles) <sup>[1]</sup> for $U = 500$ V to 690 V <sup>[2]</sup>		5000 - 7500 - 10000	2000 - 3000

[1] Mechanical and electrical durability not applicable to MasterPacT H3 and L1 versions, please refer to the MasterPacT NT/NW catalog.

[2] Electrical durability tests carried out with a power factor of 0.8 as per IEC 947-2.

**Note:**

ON: opening of N source  
 CR: closing of R source  
 OR: opening of R source  
 CN: closing of N source

# Switching devices

## Class CB

ComPacT NS	MasterPacT MTZ1	MasterPacT MTZ2/MTZ3				
NS630b to NS1600 all devices NS630b to 1600 N/H/L fixed/fixed or plug-in/plug-in	MTZ1 06 to 16 all mixing possibilities (fixed, drawout or fixed + drawout) H1/H2/H3/L1	MTZ2 08 to 40 and MTZ3 40 to 63 all mixing possibilities (fixed, drawout or fixed + drawout) N1/H1/H2/H3/L1/H10 for MTZ2 H1/H2 for MTZ3				
250 to 1600 A 750	600 to 1600 A 1000	800 to 6300 A 1000				
3, 4	■ 3, 4	■ 3, 4				
	-25 °C to +70 °C					
	48 to 415 V - 50/60 Hz 440 V - 60 Hz	48 to 415 V - 50/60 Hz 440 V - 60 Hz				
24-250 V 180 VA 180 W 800 ms	24-250 V 180 VA 180 W 800 ms	24-250 V 180 VA 180 W 800 ms				
■	■	■				
■	■	■				
■	■	■				
2 OF + SDE ■ ■	2 OF + SDE ■ ■	2 OF + SDE ■ ■				
■ (vertical or horizontal) ■ (drawout)	■ (vertical or horizontal) ■ (drawout)	■ (vertical or horizontal) ■ (drawout)				
■		■				
■	■	■				
■	■	■				
■	■	■				
ComPacT NS	MasterPacT MTZ1/MTZ2/MTZ3					
NS630b to NS1600	MTZ1 06 to 10	MTZ1 12 to 16	MTZ2 08 to 16	MTZ2 20	MTZ2 25 to 40	MTZ3 40 to 63
630 to 1600	630 to 1600	1250 to 1600	800 to 1600	2000	2500 to 4000	4000 to 6300
8000	8000	8000	10000	10000	10000	5000
2000	6000	6000	10000	8000	5000	1500
1500	3000	3000	10000	6000	2500	1500



# TransferPacT

## Mechanical interlocking

Range	ComPact		ComPact
Models	INS40 to INS80 INS100 to INS160	INS250 to INS630 INV250 to INV630	NSX100 to NSX250 NSX400 to NSX630
Current rating (A)	40 to 160	100 to 630	100 to 630
Type of device	Class PC	Class PC	Class PC and Class CB

Interlocking by toggles

<b>M</b>			
----------	--	--	--

Interlocking by rotary handles

<b>M</b>			
----------	--	--	--

Interlocking by keylocks with captive keys

<b>M</b>			
----------	--	--	--

Interlocking by a base plate

<b>A</b>			
----------	--	--	--



# TransferPacT

## Mechanical interlocking

Range	ComPacT	MasterPacT	
Models	NS630b to NS1600	MTZ1 06 to 16	MTZ2 08 to 40 and MTZ3 40 to 63
Current rating (A)	630b to 1600	630 to 1600	800 to 6300
Type of device	Class PC and Class CB	Class PC and Class CB	Class PC and Class CB

### Interlocking by extended rotary handles



### Interlocking via device keylocks by captive keys

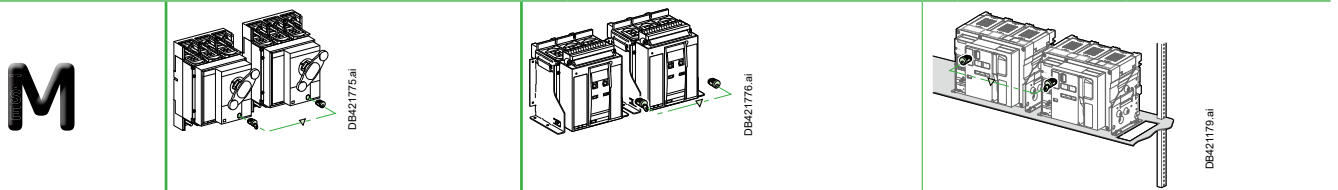

### Mechanical interlocking using connecting rods

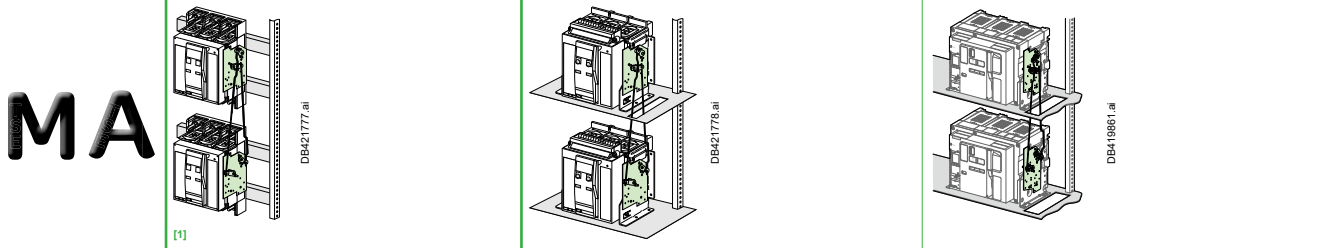

### Mechanical interlocking by cables

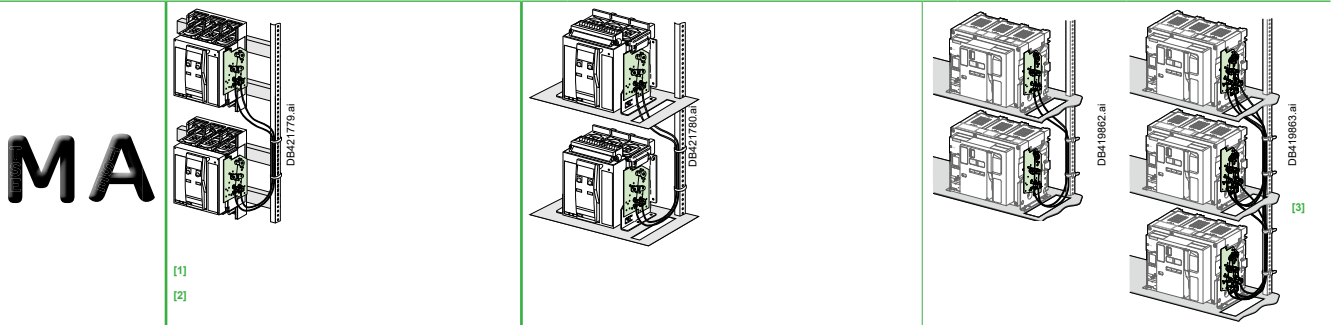

### Mechanical interlocking by cables

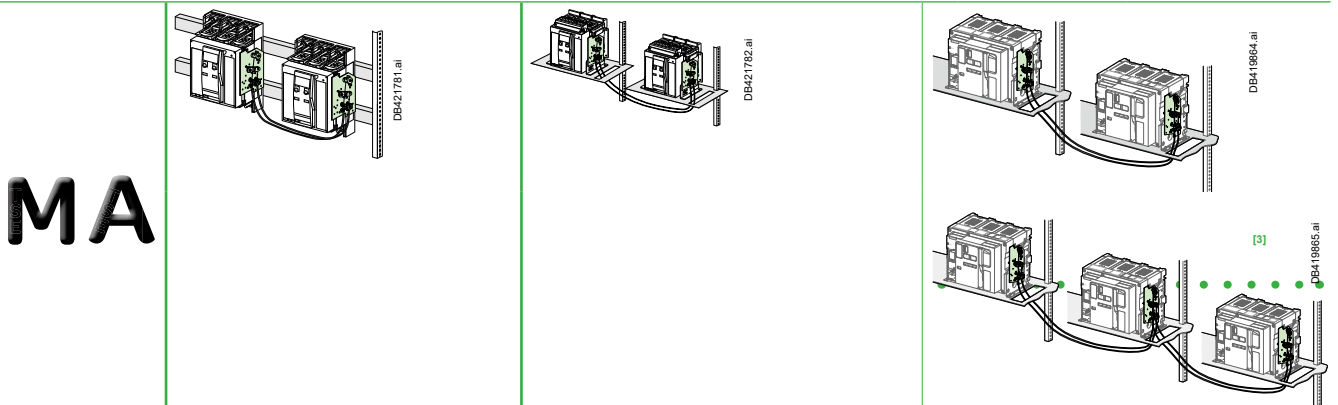

[1] Implemented with NS630b to NS1600 electrically-operated devices only.  
 [2] For source-changeover systems using cables, always respect the installation conditions specified on.  
 [3] Not compatible with automatic controller.

**Note:** for other cases, please consult us.



# TransferPacT

## Mechanical interlocking



PB113435.eps

Interlocking of two or three toggle-controlled devices.



PB113415-N.eps

Interlocking of two devices by rotary handles.

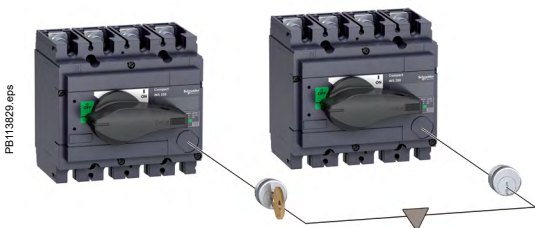

PB113829.eps

Interlocking with keylocks.

### Interlocking of two or three toggle-controlled devices

#### Interlocking system

Two devices can be interlocked using this system. Two identical interlocking systems can be used to interlock three devices installed side by side.

Authorized positions:

- one device closed (ON), the others open (OFF)
- all devices open (OFF).

The system is locked using one or two padlocks (Ø5 to 8 mm).

This system can be expanded to more than three devices.

There are two interlocking-system models:

- one for ComPacT INS/INV
- one for ComPacT NSX100 to NSX250
- one for ComPacT NSX400 to NSX630.

#### Combinations of Normal and Replacement devices

All toggle-controlled fixed or plug-in ComPacT NSX100 to NSX630 circuit breakers and switch-disconnectors of the same frame size can be interlocked. The devices must be either all fixed or all plug-in versions.

### Interlocking of two devices by rotary handles

#### Interlocking system

Interlocking involves padlocking the rotary handles on two devices which may be either circuit breakers or switch-disconnectors.

Authorized positions:

- one device closed (ON), the other open (OFF)
- both devices open (OFF).

The system is locked using up to three padlocks (Ø5 to 8 mm).

There are two interlocking-system models:

- one for ComPacT INS/INV
- one for ComPacT NSX100 to NSX250
- one for ComPacT NSX400 to NSX630.

#### Combinations of Normal and Replacement devices

All rotary-handle fixed or plug-in ComPacT NSX100 to NSX630 circuit breakers and switch-disconnectors of the same frame size can be interlocked. The devices must be either all fixed or all plug-in versions.

### Interlocking of devices by keylocks (captive keys)

Interlocking using keylocks is very simple and makes it possible to interlock two or more devices that are physically distant or that have very different characteristics, for example medium-voltage and low-voltage devices or a ComPacT NSX100 to NSX630 switch-disconnector and circuit breaker.

#### Interlocking system

Each device is equipped with an identical keylock and the key is captive on the closed (ON) device. A single key is available for all devices. It is necessary to first open (OFF position) the device with the key before the key can be withdrawn and used to close another device.

A system of wall-mounted captive key boxes makes a large number of combinations possible between many devices.

#### Combinations of Normal and Replacement devices

All rotary-handle ComPacT NSX100 to NSX630 circuit breakers and switch-disconnectors can be interlocked between each other or with any other device equipped with the same type of keylock.

# TransferPacT

## Mechanical interlocking

### Interlocking of two devices by base plate

#### Interlocking system

A base plate designed for two ComPacT NSX devices can be installed horizontally or vertically on a mounting rail. Interlocking is carried out on the base plate by a mechanism located behind the devices. In this way, access to the device controls and trip units is not blocked.

#### Combinations of Normal and Replacement devices

All rotary-handle and toggle-controlled ComPacT NSX100 to NSX630 circuit breakers and switch-disconnectors can be interlocked. Devices must be either all fixed or all plug-in versions, with or without earth-leakage protection or measurement modules.

An adaptation kit is required to interlock:

- two plug-in devices
- a ComPacT NSX100 to NSX250 with an NSX400 to NSX630.

Connection to the downstream installation can be made easier using a coupling accessory.

#### Downstream coupling accessory

This accessory simplifies connection to bars and cables with lugs. It may be used to couple two switch-disconnectors and circuit breakers of the same size, ComPacT INS/INV100 to 630 and ComPacT NSX100 to 630.

Pitch between outgoing terminals:

- ComPacT INS250 and INV100 to 250: 35 mm
- ComPacT INS/INV320 to INS/INV630: 45 mm
- ComPacT NSX100 to NSX250: 35 mm
- ComPacT NSX400 to NSX630: 45 mm.

For ComPacT NSX circuit breakers, the downstream coupling accessory can be used only with **fixed versions**.

#### Connection and insulation accessories

The coupling accessory can be fitted with the same connection and insulation accessories as the circuit breakers and switch-disconnectors.

Possible uses	Downstream coupling	
	Possible mounting	Outgoing pitch (mm)
<b>Manual source-changeover systems</b>		
INS250 (100 to 250 A) with rotary handle	■	35
NSX100 to NSX250 with rotary handle	■	35
NSX100 to NSX250 on base plate with toggle control	■	35
INS400 to INS630 (320 to 630 A) with rotary handle	■	45
NSX400 to NSX630 with rotary handle	■	45
NSX400 to NSX630 on base plate with toggle control	■	45

**Note:** for usage of PowerTag NSX on NSX mounted on interlocking plate, please consult us.



Interlocking on a base plate.

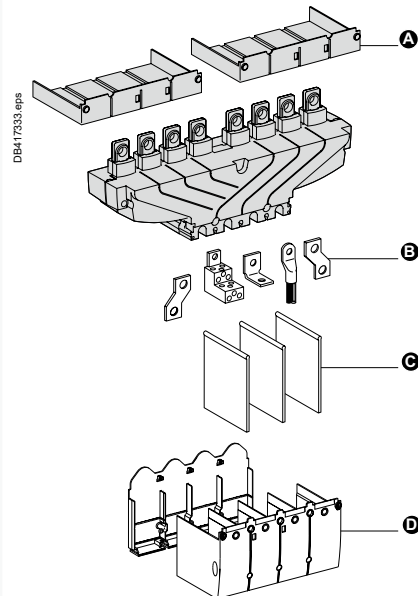

- A** Short terminal shields
- B** Terminals
- C** Interphase barriers
- D** Long terminal shields



# TransferPacT

## Mechanical interlocking

For implementing the mechanical interlocking, two different possibilities are offered:

- interlocking with rods
- interlocking with cables.

Note: for mechanical interlocking application with connecting rods and cables, pushbutton cover is mandatory to prevent wrong mechanical close order.

Commercial references for pushbutton cover:

- MasterPacT MTZ1 : LV833897
- MasterPacT MTZ2 and MTZ3 : LV848536
- ComPacT NS630b to 1600: 33897

### Interlocking with rods

#### Interlocking of two ComPacT NS630b to 1600 devices using connecting rods

Both devices must be installed one above the other.

For ComPacT NS, only associations between similar type devices are allowed (2 fixed or 2 drawout devices).

#### Installation

This function requires:

- an adaptation fixture on the right side of each circuit breaker or switch-disconnector
- a set of connecting rods with no-slip adjustments.

The adaptation fixtures, connecting rods and circuit breakers or switch-disconnectors are supplied separately, ready for assembly.

The maximum vertical distance between the fixing plates is 900 mm.

#### Possible combinations of "S1" and "S2" source circuit breakers

Combinations are possible between ComPacT NS devices and between ComPacT NS devices with MasterPacT MTZ1 devices (either 2 fixed or 2 withdrawable/drawout devices).

#### Interlocking of two MasterPacT MTZ using connecting rods

Both devices must be installed one above the other.

For MasterPacT MTZ1 only associations between similar type devices are allowed (2 fixed or 2 drawout devices).

For MasterPacT MTZ2 and MTZ3, all mixed associations between fixed type and drawout type devices are possible.

PB110491\_R\_34.eps

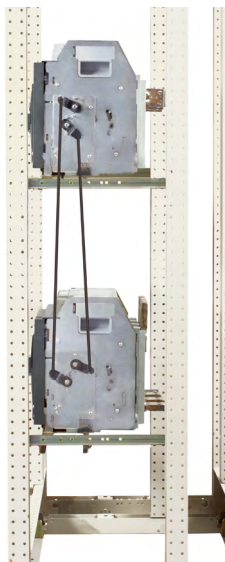

Interlocking of two MasterPacT MTZ1, MTZ2/MTZ3 circuit breakers using connecting rods.

	Source 2							
	Fixed			Drawout				
	NS630b to NS1600	MTZ1	MTZ2	MTZ3	NS630b to NS1600	MTZ1	MTZ2	MTZ3
<b>Source 1</b>								
<b>Fixed</b>								
NS630b to NS1600	●	●						
MTZ1	●	●						
MTZ2			●	●			●	●
MTZ3			●	●			●	●
<b>Drawout</b>								
NS630b to NS1600					●	●		
MTZ1					●	●		
MTZ2			●	●			●	●
MTZ3			●	●			●	●

#### Installation

This function requires:

- an adaptation fixture on the right side of each circuit breaker or switch-disconnector
- a set of connecting rods with no-slip adjustments
- a mechanical operation counter CDM (mandatory).

The adaptation fixtures, connecting rods, circuit breakers and switch-disconnectors are supplied separately, ready for assembly.

The maximum vertical distance between the fixing plates is 900 mm.

# TransferPacT

## Mechanical interlocking

### Interlocking with cables

#### Interlocking of two ComPacT NS630b to 1600 devices using cables

For cable interlocking, the circuit breakers may be mounted one above the other or side-by-side.

The interlocked devices may be fixed or drawout, three-pole or four-pole, and have different ratings and sizes.

#### Installation

This function requires:

- an adaptation fixture on the right side of each device
- a set of cables with no-slip adjustments.

The maximum distance between the fixing plates (vertical or horizontal) is 2000 mm.

#### Possible combinations of “S1” and “S2” source circuit breakers

All mixed associations between ComPacT NS 630b to 1600 and MasterPacT MTZ1 or MTZ2 or MTZ3 fixed type and drawout type devices are possible.

#### Interlocking of two or three MasterPacT MTZ using cables

For cable interlocking, the circuit breakers can be installed either one above the other or side-by-side. All mixed associations between MasterPacT MTZ1, MTZ2, MTZ3 fixed type and drawout type devices are possible.

**Note:** mechanical interlocking for 3 devices is only possible with MTZ2 and MTZ3.

#### Interlocking between two MasterPacT MTZ1, MTZ2, MTZ3 devices

This function requires:

- an adaptation fixture on the right side of each device
- a set of cables without slip adjustments
- a mechanical operation counter CDM (mandatory).

The maximum distance between the fixing plates (vertical or horizontal) is 2000 mm.

#### Interlocking between three MasterPacT MTZ2, MTZ3 devices

This function requires:

- a specific adaptation fixture installed on the right side of each device
- two sets of cables without slip adjustments
- a mechanical operation counter CDM (mandatory).

The maximum distance between the fixing plates (vertical or horizontal) is 1000 mm.

#### Installation

The adaptation fixtures, sets of cables and circuit breakers or switch-disconnectors are supplied separately, ready for assembly.

Installation conditions for cable interlocking systems:

- cable length: 2.5 m
- cable bending radius: greater than 100 mm
- maximum number of curves: 3.

**Note:** for cable length higher than 2.5 m please consult us before ordering the circuit breakers for a customized solution.

#### Choice criteria

In applications where the continuity of service is critical<sup>[1]</sup> (data centers, airports, hospitals, marine, oil&gas, process industry, etc.), mechanical interlocking by rods and drawout devices are strongly recommended.

Mechanical interlocking by rods is preferred as less energy is consumed by friction, so it has less effect on the circuit breaker closing energy.

In terms of breaker mounting type, the drawout version is preferred as :

- it provides mechanical isolation of the circuit breaker from possible external stress on the terminals by having a flexible connection at cluster level
- it allows simple and total access for periodic maintenance
- it allows quick replacement of the device if necessary.

When not possible, cable interlocking or fixed versions can be used, but the installation rules detailed in the 2 sections below must be strictly respected and mainly:

- the busbars or the cables used for power connection must apply no stress on the circuit breaker terminals.

Their weight must be supported by the switchboard frame.

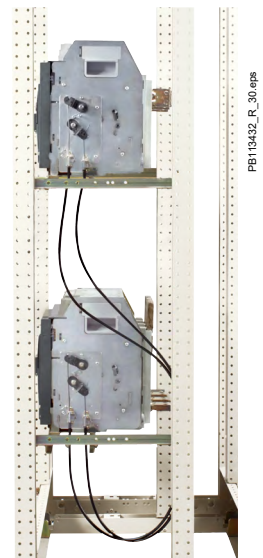

Interlocking of two MasterPacT circuit breakers using cables.

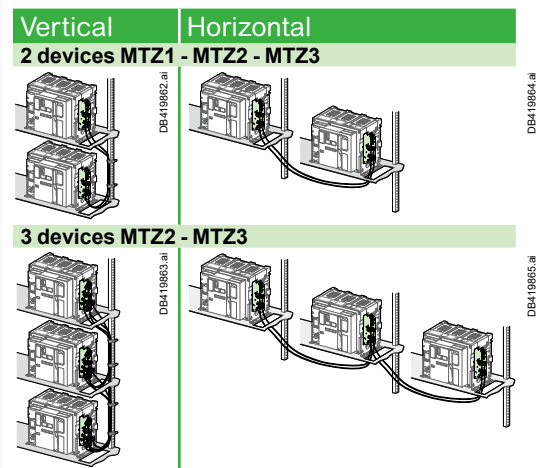

<sup>[1]</sup> For more details please contact your local support.

**Note:** for more details on installation rules, please also refer to “MasterPacT MTZ User Guide”.

# TransferPacT

## Electrical interlocking - IVE unit

Electrical interlocking is used with a mechanical interlocking system. Moreover, the relays controlling the closing order to the "N" and "R" circuit breakers must be mechanically and/or electrically interlocked to prevent them from giving simultaneous closing commands.

Electrical interlocking is carried out by an electrical control device.

For ComPacT NSX up to 630 A, electrical interlocking is implemented by the IVE unit integrating control circuits and an external terminal block in accordance with the page C-38 of the chapter "Electric diagrams" of this catalog.

The integrated control circuits implement the time delays required for correct source transfer.

For ComPacT NS630b to NS1600 and MasterPacT, this function can be implemented in one of two ways:

- Using the IVE unit
- By an electrician based on the diagrams in accordance with the pages C-42 to C-47 of the chapter "Electric diagrams" of this catalog.

### Characteristics of the IVE unit

- External connection terminal block:
  - Inputs: circuit breaker control signals
  - Outputs: status of the SDE contacts on the "N" and "R" source circuit breakers.
- 2 connectors for the two "N" and "R" source circuit breakers:
  - Inputs:
    - Status of the OF contacts on each circuit breaker (ON or OFF)
    - Status of the SDE contacts on the "N" and "R" source circuit breakers
  - Outputs: power supply for operating mechanisms.
- Control voltage:
  - 24 to 250 V DC
  - 48 to 415 V 50/60 Hz - 440 V 60 Hz.

The IVE unit control voltage must be same as that of the circuit breaker operating mechanisms.



IVE unit.

### IVE unit

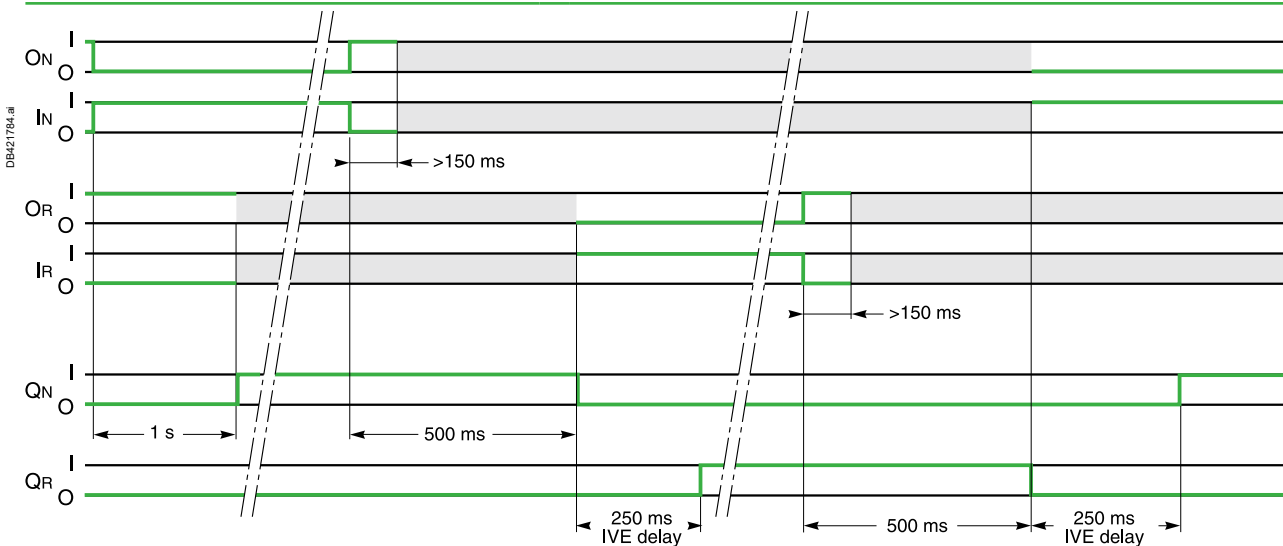

### Symbols

- |   |   |
|---|---|
| QN: "Normal" ComPacT circuit breaker equipped for remote operation (motor mechanism)      | IN: Circuit breaker QN closing order    |
| QR: "Replacement" ComPacT circuit breaker equipped for remote operation (motor mechanism) | IR: Circuit breaker QR closing order    |
| ON: Circuit breaker QN opening order  | L1: Faulty "Normal" indication LED      |
| OR: Circuit breaker QR opening order  | L2: Faulty "Replacement" indication LED |

### Key

- O: OFF (circuit open)
- I: ON (circuit closed)
- : either ON or OFF.

**Note:** following all trips (overload, short-circuit, earth-leakage fault, voluntary trip), a manual reset on the front of the motor mechanism is required.

# TransferPacT

## Electrical interlocking - IVE unit

### Necessary equipment

**For ComPacT NSX100 to NSX630, each circuit breaker must be equipped with:**

- A motor mechanism
- An OF contact
- An SDE contact

The components are supplied ready for assembly and the circuit breakers prewired. The prewiring must not be modified.

**For ComPacT NS630b to NS1600, each circuit breaker must be equipped with:**

- A motor mechanism
- An available OF contact
- A CE connected-position contact (carriage switch) on withdrawable circuit breakers
- An SDE contact

**For MasterPacT MTZ, each circuit breaker must be equipped with:**

- A remote-operation system made up of:
  - MCH gear motor
  - MX or MN opening release
  - XF closing release
  - PF "ready to close" contact
- CDM mechanical operation counter (mandatory)
- An available OF contact
- One to three CE connected-position contacts (carriage switches) on drawout circuit breakers (depending on the installation).

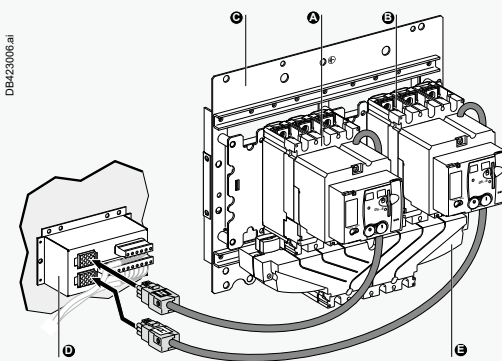

ComPacT NSX

- A** Circuit breaker QS1 equipped with a motor mechanism and auxiliary contacts, connected to the N source
- B** Circuit breaker QS2 equipped with a motor mechanism and auxiliary contacts, connected to the R source
- C** Base plate with mechanical interlocking
- D** Electrical interlocking unit IVE
- E** Coupling accessory (downstream connection)

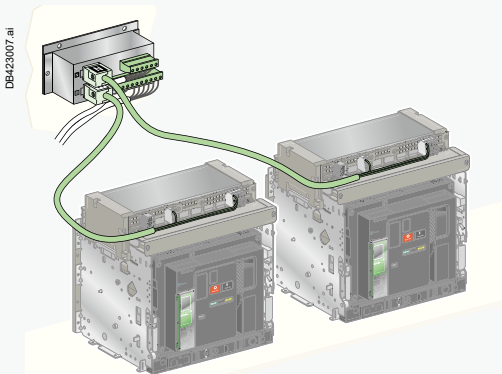

MasterPacT MTZ

# TransferPacT controllers

## Controller selection

By combining a remote-operated source-changeover system with an integrated BA or UA automatic controller, it is possible to automatically control source transfer according to user-selected sequences. These controllers can be used on source-changeover systems comprising 2 circuit breakers. For source-changeover systems comprising 3 circuit breakers, the automatic control diagram must be prepared by the installer as a complement to diagrams provided in the “electrical diagrams” section of this catalog.



BA controller.



UA controller.

Controller		BA	UA				
Compatible circuit breakers		All ComPact NS, ComPact NSX and MasterPacT circuit breakers					
<b>4-position switch</b>							
Automatic operation		●	●				
Forced operation on “Normal” source		●	●				
Forced operation on “Replacement” source		●	●				
Stop (both “Normal” and “Replacement” sources off)		●	●				
<b>Automatic operation</b>							
Monitoring of the “Normal” source and automatic transfer		●	●				
Generator set startup control			●				
Delayed shutdown (adjustable) of generator set			●				
Load shedding and reconnection of non-priority circuits			●				
Transfer to the “Replacement” source if one of the phases of the “Normal” phase is absent			●				
<b>Test</b>							
By opening the P25M circuit breaker supplying the controller		●					
By pressing the test button on the front of the controller			●				
<b>Indications</b>							
Circuit breaker status indication on the front of the controller: on, off, fault trip		●	●				
Automatic mode indicating contact		●	●				
<b>Other functions</b>							
Selection of type of “Normal” source: single-phase or three-phase (for example, 220 V single-phase or 220 V three-phase)			●				
Voluntary transfer to “Replacement” source (e.g. energy management commands)		●	●				
During peak-tariff periods (energy management commands) forced operation on “Normal” source if “Replacement” source not operational			●				
Additional contact (not part of controller). Transfer to “Replacement” source only if contact is closed (e.g. used to test the frequency of UR).		●	●				
Setting of maximum startup time for the replacement source			●				
<b>Power supply</b>							
Control voltages <sup>[1]</sup>	110 V	●	●				
	220 to 240 V 50/60 Hz	●	●				
	380 to 415 V 50/60 Hz and 440 V 60 Hz	●	●				
<b>Operating thresholds</b>							
Undervoltage	0.35 Un ≤ voltage ≤ 0.7 Un	●	●				
Phase failure	0.5 Un ≤ voltage ≤ 0.7 Un		●				
Voltage presence	voltage ≥ 0.85 Un	●	●				
<b>IP degree of protection (EN 60529) and IK degree of protection against external mechanical impacts (EN 50102)</b>							
Front	IP40	●	●				
Side	IP30	●	●				
Connectors	IP20	●	●				
Front	IK07	●	●				
<b>Characteristics of output contacts (dry, volt-free contacts)</b>							
Rated thermal current (A)	8						
Minimum load	10 mA at 12 V						
Output contacts:	Position of the Auto/Stop switch	●	●				
	Load shedding and reconnection order		●				
	Generator set start order.		●				
<b>Utilisation category (IEC 947-5-1)</b>		<b>AC</b>				<b>DC</b>	
		AC12	AC13	AC14	AC15	DC12	DC13
Operational current (A)	24 V	8	7	5	5	8	2
	48 V	8	7	5	5	2	-
	110 V	8	6	4	4	0.6	-
	220/240 V	8	6	4	3	-	-
	250 V	-	-	-	-	0.4	-
	380/415 V	5	-	-	-	-	-
	440 V	4	-	-	-	-	-
	660/690 V	-	-	-	-	-	-

[1] The controller is powered by the ACP control plate. The same voltage must be used for the ACP plate, the IVE unit and the circuit breaker operating mechanisms. If this voltage is the same as the source voltage, then the “Normal” and “Replacement” sources can be used directly for the power supply. If not, an isolation transformer must be used.



# TransferPacT controllers

## Controller installation

### TransferPacT ACP control plate

The control plate provides in a single unit:

- protection for the BA or UA controller with two highly limiting P25M circuit breakers (infinite breaking capacity) for power drawn from the AC source
- control of circuit breaker ON and OFF functions via two relay contactors
- connection of the circuit breakers to the BA or UA controller via a built-in terminal block.

#### Control voltages

- 110 V 50/60 Hz.
- 220 to 240 V 50/60 Hz.
- 380 to 415 V 50/60 Hz and 440 V 60 Hz.

The same voltage must be used for the TransferPacT ACP control plate, the controller and the circuit breaker operating mechanisms.

#### Installation

Connection between the TransferPacT ACP control plate and the IVE unit may use:

- wiring done by the installer
- prefabricated wiring (optional).

### Installation of the BA and UA controllers

The BA and UA controllers may be installed in one of two manners:

- directly mounted on the TransferPacT ACP control plate
- mounted on the front panel of the switchboard
- if the length of the connection between the controller and the control plate (ACP) is less than or equivalent to 1 m, the connecting cable **ref. 29368** can be ordered as an optional extra. Cables longer than 1 m, but not longer than 2 m will be the responsibility of the installer.



TransferPacT ACP control plate.

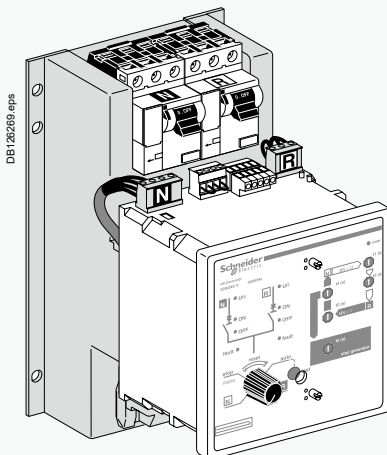

Mounting on the TransferPacT ACP control plate.

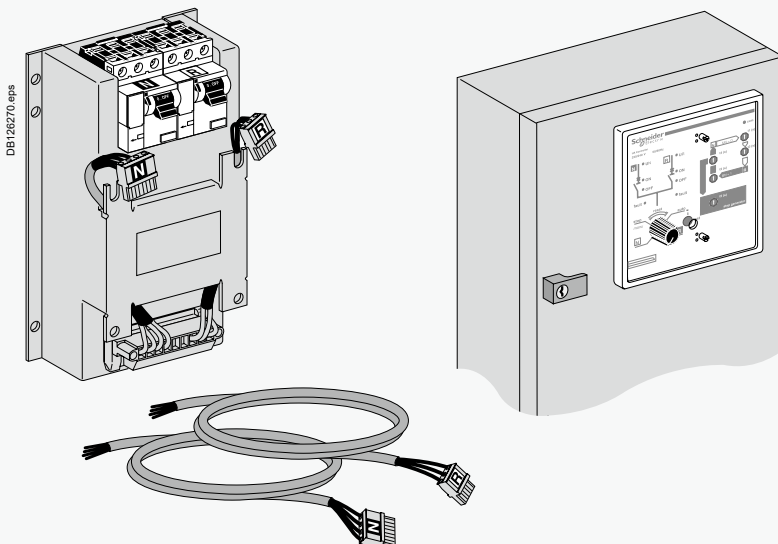

Mounting on the front panel of the switchboard.

# TransferPacT controllers

## BA controller

The BA controller is used to create simple source-changeover systems that switch from one source to another depending on the presence of voltage  $U_N$  on the "Normal" source. It is generally used to manage two permanent sources and can control ComPact NS, ComPact NSX and MasterPacT MTZ circuit breakers and switch-disconnectors.

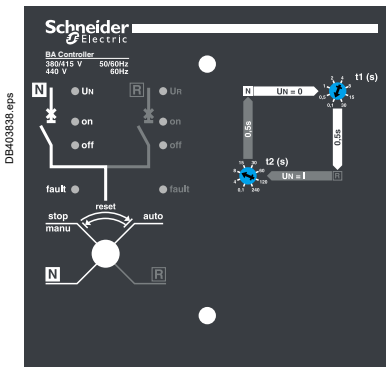

Front of the BA controller.

### Operating modes

A four-position switch may be used to select:

- automatic operation
- forced operation on the "Normal" source
- forced operation on the "Replacement" source
- stop (both "Normal" and "Replacement" sources off).

### Setting the time delays

Time delays are set on the front of the controller.

**t1.** delay between detection that the "Normal" source has failed and the transmission of the order to open the "Normal" source circuit breaker (adjustable from 0.1 to 30 seconds).

**t2.** delay between detection that the "Normal" source has returned and the transmission of the order to open the "Replacement" source circuit breaker (adjustable from 0.1 to 240 seconds).

### Circuit breaker commands and status indications

The status of the circuit breakers is indicated on the front of the controller.

- ON, OFF, fault.

A built-in terminal block may be used to connect the following input/output signals:

- inputs:
  - voluntary order to transfer to source R (e.g. for special tariffs, etc.)
  - additional control contact (not part of the controller). Transfer to the "Replacement" source takes place only if the contact is closed (e.g. used to test the frequency of UR, etc.)
- outputs:
  - indication of operation in automatic or stop mode via changeover contacts.

### Test

It is possible to test the operation of the BA controller by turning OFF (opening) the P25M circuit breaker for the "Normal" source and thus simulating a failure of voltage  $U_N$ .

# TransferPacT controllers

## BA controller

### Operating sequences

Switch set to Auto (automatic operation and special-tariff mode)

Switch set to the "N" position (forced operation on the "Normal" source)

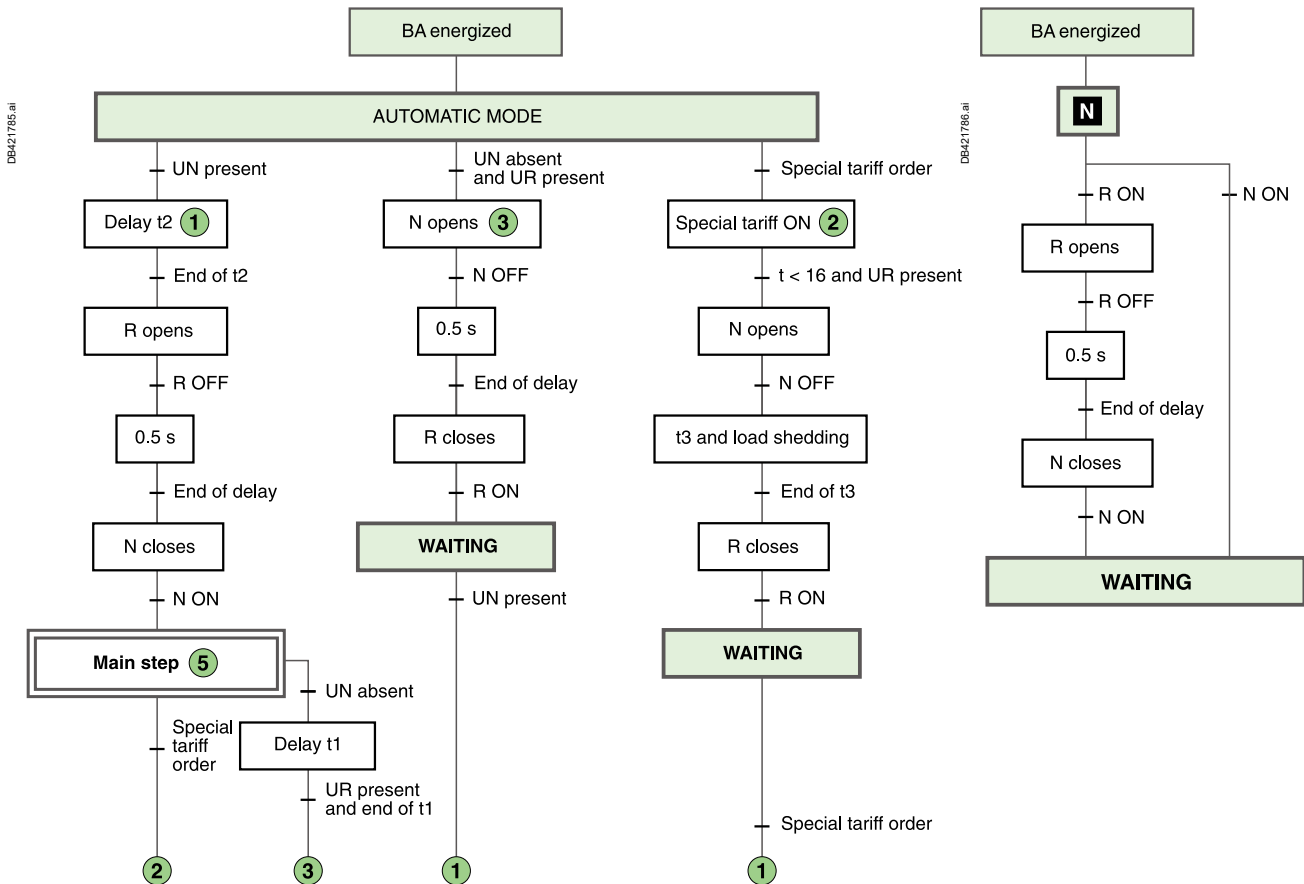

Switch set to the "R" position (forced operation on the "Replacement" source)

Switch set to the "Stop" position



**Key**

- UN: "Normal" source voltage
- UR: "Replacement" source voltage
- N: "Normal" source circuit breaker
- R: "Replacement" source circuit breaker

① The number sends to the indicated step when the condition is true.

**WAITING** The system exits this mode when the operating mode is modified or when an external event occurs (e.g. failure or return of UN).



# TransferPacT controllers

## UA controller

The UA controller is used to create a source-changeover system integrating the following automatic functions:

- transfer from one source to another depending on the presence of voltage UN on the “Normal” source
- startup of an engine generator set
- shedding and reconnection of non-priority circuits
- transfer to the “Replacement” source if one of the phases on the “Normal” source fails.

The UA controller can control ComPact NS, ComPact NSX and MasterPacT MTZ devices.

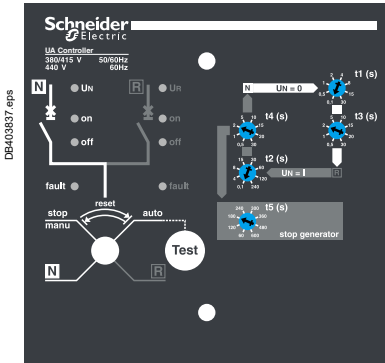

Front of the UA controller.

### Operating modes

A four-position switch may be used to select:

- automatic operation
- forced operation on the “Normal” source
- forced operation on the “Replacement” source
- stop (both “Normal” and “Replacement” sources off, then manual operation).

### Setting the time delays

Time delays are set on the front of the controller.

- t1.** delay between detection that the “Normal” source has failed and the transmission of the order to open the “Normal” source circuit breaker (adjustable from 0.1 to 30 seconds).
- t2.** delay between detection that the “Normal” source has returned and the transmission of the order to open the “Replacement” source circuit breaker (adjustable from 0.1 to 240 seconds).
- t3.** delay following opening of QN with load shedding and before closing of QR (adjustable from 0.5 to 30 seconds).
- t4.** delay following opening of QR with load reconnection and before closing of QN (adjustable from 0.5 to 30 seconds).
- t5.** delay for confirmation that UN is present before shutting down the engine generator set (adjustable from 60 to 600 seconds).
- t6.** delay before startup of the engine generator set (120 or 180 seconds).

### Commands and indications

Circuit breaker status indications on the front of the controller:

- ON, OFF, fault.

A built-in terminal block may be used to connect the following input/output signals:

- inputs:
  - voluntary order to transfer to source R (e.g. for special tariffs, etc.)
  - additional control contact (not part of the controller). Transfer to the “Replacement” source takes place only if the contact is closed (e.g. used to test the frequency of UR, etc.)
- outputs:
  - control of an engine generator set (ON / OFF)
  - shedding of non-priority circuits
  - indication of operation in automatic mode via changeover contacts.

### Distribution-system settings

Three switches are used to:

- select the type of “Normal” source, whether single-phase or three-phase (e.g. 240 V single-phase or 240 V three-phase)
- select whether to remain (or not) on the “Normal” source if the “Replacement” source is not operational during operation on special tariffs
- select the maximum permissible startup time for the engine generator set during operation on special tariffs (120 or 180 seconds).

### Test

A pushbutton on the front of the controller may be used to test transfer from the “Normal” source to the “Replacement” source, then the return to the “Normal” source. The test lasts approximately three minutes.

### COM communications option

Using the internal bus protocol, this option may be used to remote the following information:

- circuit breaker status (ON, OFF, fault trip)
- presence of the “Normal” and “Replacement” voltages
- presence of an order for forced operation (e.g. special tariffs)
- settings and configuration information
- status of non-priority circuits (loads shed or not)
- position of the switch (stop, auto, forced operation on the “Normal” source, forced operation on the “Replacement” source).

# TransferPacT controllers

## UA controller

### Operating sequences, forced operation mode

Switch set to the "R" position  
(forced operation on the "Replacement" source)

Switch set to the "N" position  
(forced operation on the "Normal" source)

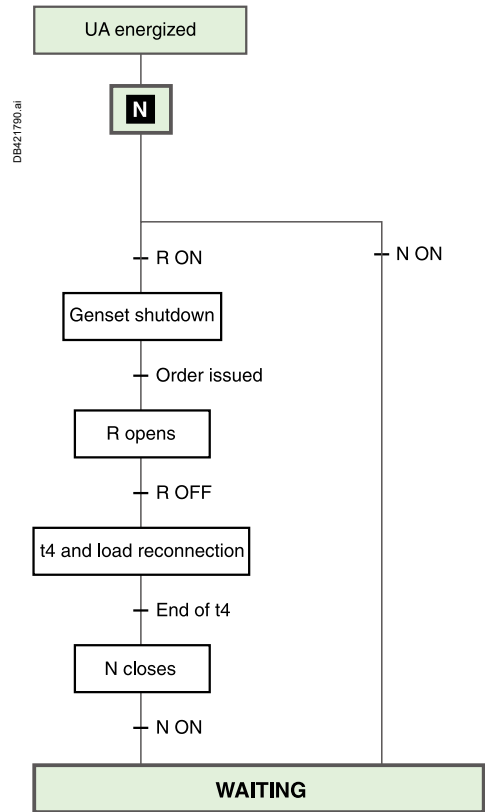
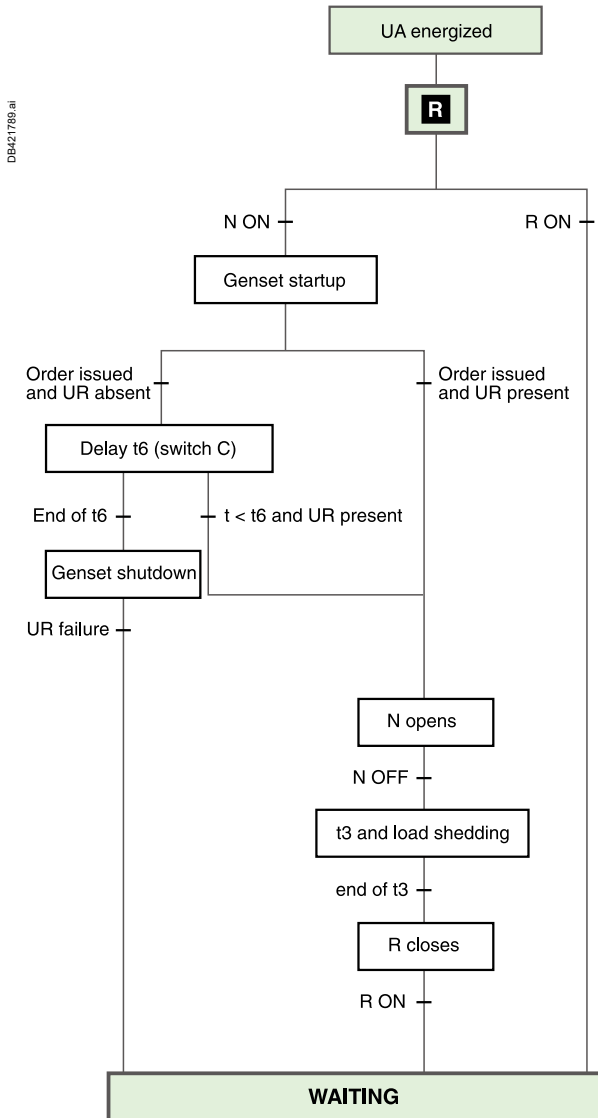

**WAITING** The system exits this mode when the operating mode is modified or when an external event occurs (e.g. failure or return of UN).

When the UA controller is not energized, the output for generator set startup is activated).

**Key**

- UN: "Normal" source voltage
- UR: "Replacement" source voltage
- N : "Normal" source circuit breaker
- R: "Replacement" source circuit breaker

Switch set to the "Stop" position

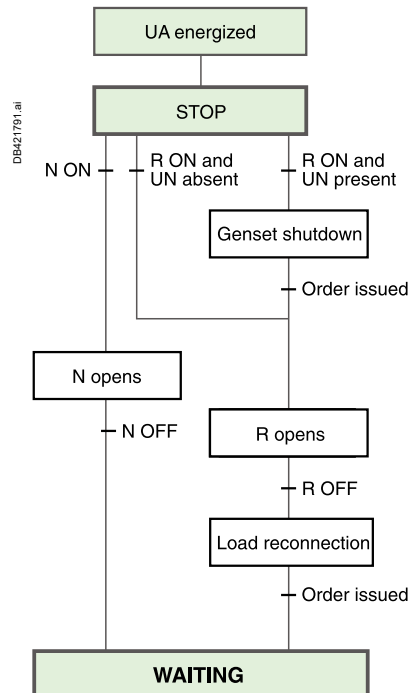

# TransferPacT controllers

## UA controller

### Operating sequences, special-tariff mode

Switch set to the "Auto" position (special-tariff mode)

**WAITING** The system exits this mode when the operating mode is modified or when an external event occurs (e.g. failure or return of UN).

When the UA controller is not energized, the output for generator set startup is activated.

DB42.792.ai

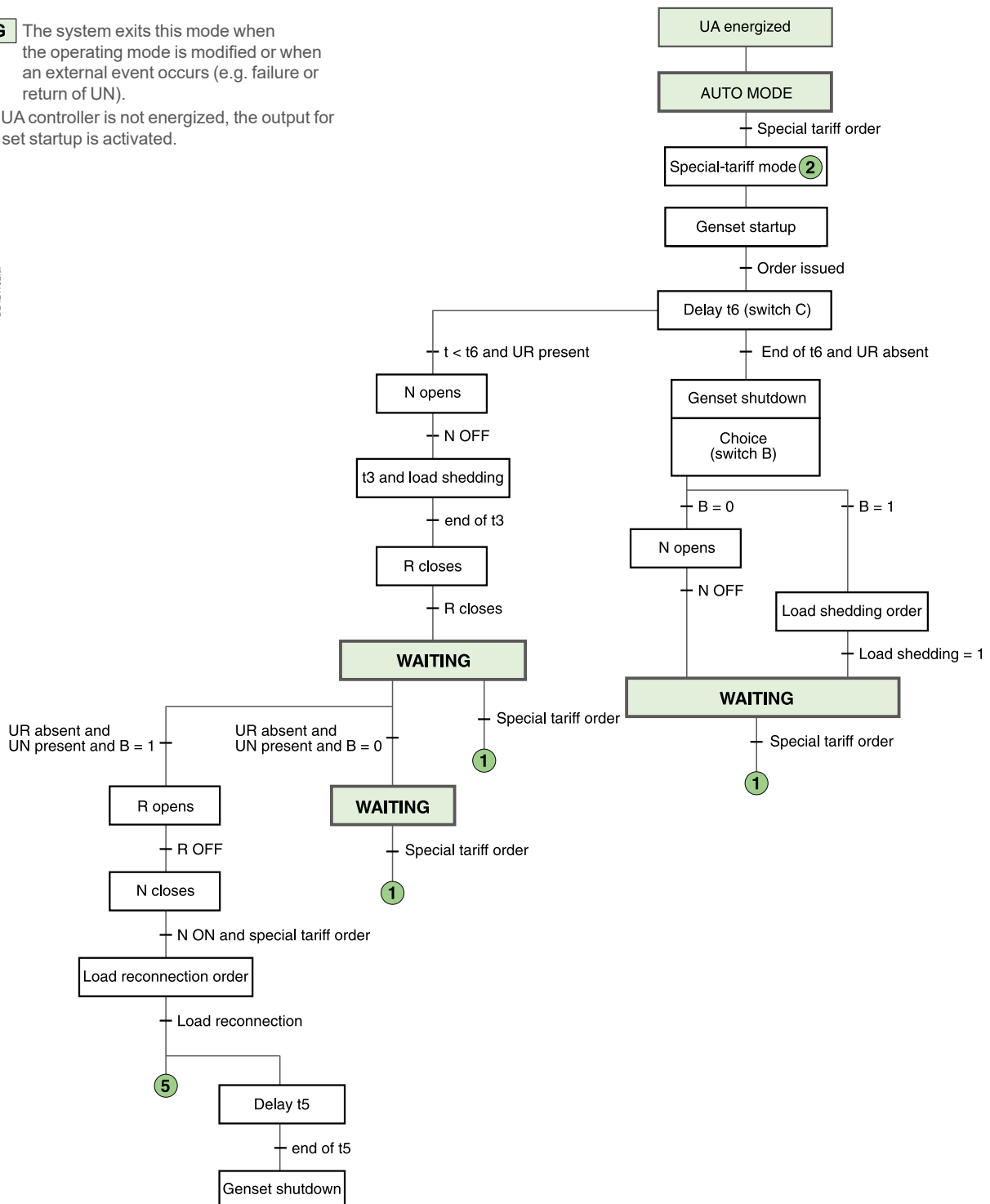

**Key**

- UN: "Normal" source voltage
- UR: "Replacement" source voltage
- N: "Normal" source circuit breaker
- R: "Replacement" source circuit breaker
- B: Penalties accepted (N ON), i.e. B = 1

① The number sends to the indicated step when the condition is true.

# TransferPacT controllers

## UA controller

### Operating sequences, test mode and automatic operation

Switch set to the "Auto" position (automatic operation and test mode).

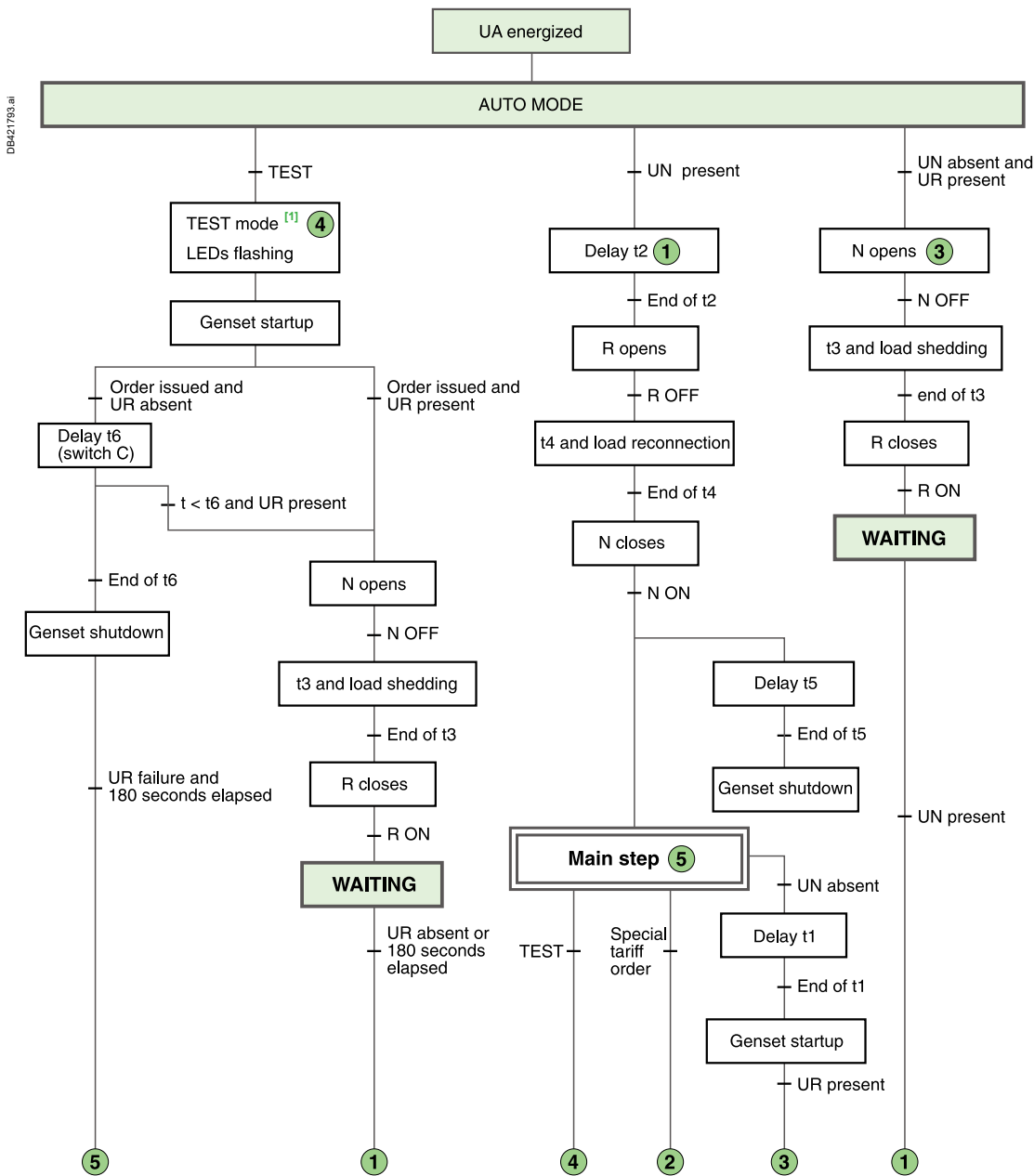

**WAITING** The system exits this mode when the operating mode is modified or when an external event occurs (e.g. failure or return of UN).

When the UA controller is not energized, the output for generator set startup is activated).

**Key**

- UN: "Normal" source voltage
- UR: "Replacement" source voltage
- N: "Normal" source circuit breaker
- R: "Replacement" source circuit breaker
- B: Penalties accepted (N ON), i.e. B = 1

**[1]** The test lasts 180 seconds.

**1** The number sends to the indicated step when the condition is true.



# TransferPacT controllers

## UA/BA controller

### BA controller

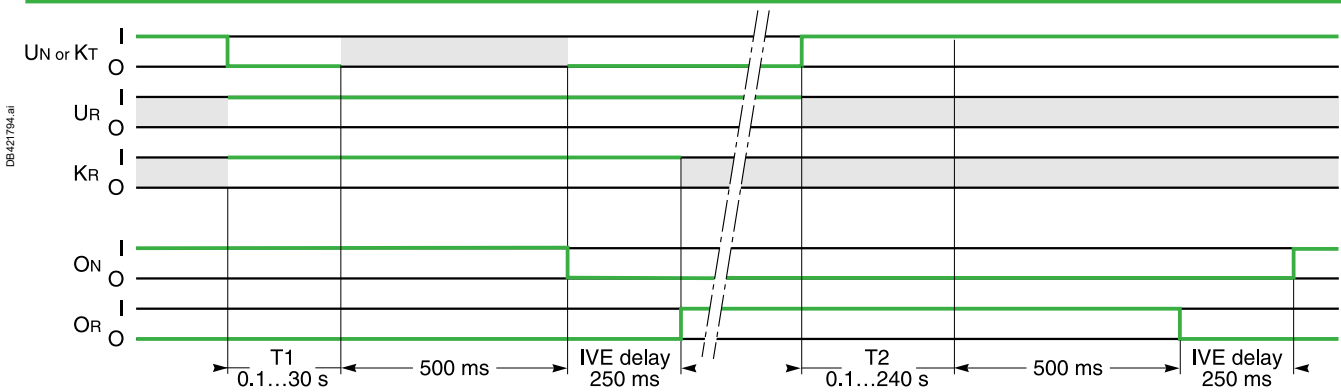

**Inputs**

- UN: "Normal" source voltage
- UR: "Replacement" source voltage
- KT: order for forced-operation on R
- KR: additional check before transfer

**Outputs**

- QN: "Normal" source circuit breaker
- QR: "Replacement" source circuit breaker

### UA controller

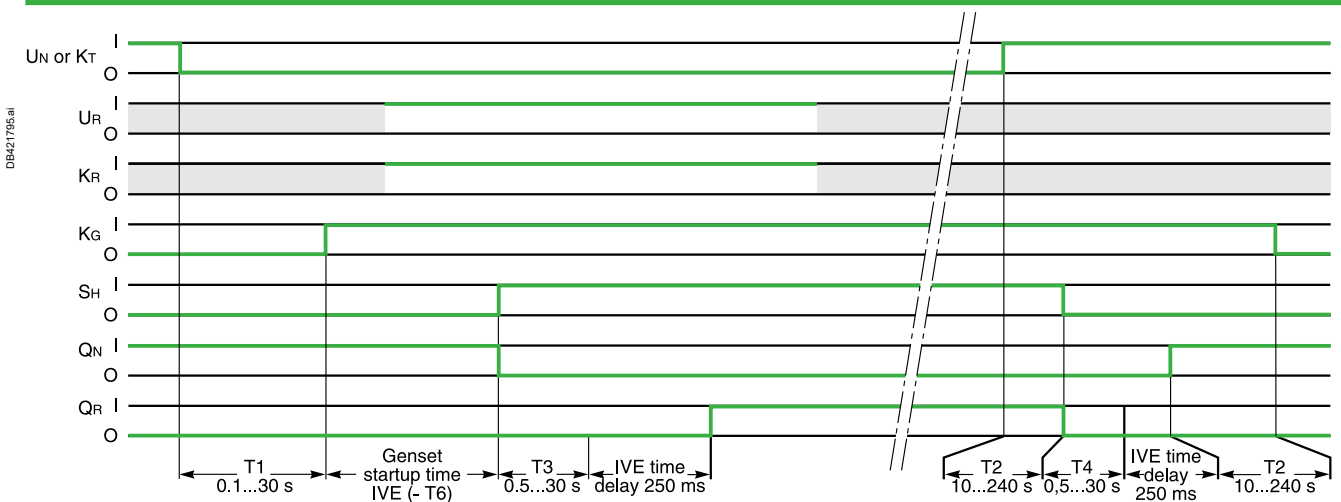

**Inputs**

- UN: "Normal" source voltage
- UR: "Replacement" source voltage
- KT: order for forced-operation on R

**Outputs**

- KG: order to the genset
- SH: load-shedding order
- QN: "Normal" source circuit breaker
- QR: "Replacement" source circuit breaker

**Key**

- O: OFF (circuit open)
- I: ON (circuit closed)
- : either ON or OFF.

**Important**

If UR is not ON when the transfer order is issued (KT or UN), the sequence is not carried out. If KR status is not ON when the transfer order is issued (KT or UN), the transfer sequence is carried out later when KR status becomes I.





# Manual source-changeover systems

## ComPacT INS/INV

### Class PC

#### Interlocking of direct rotary handles

(ComPacT INS/INV250 - 100 to 250 A / ComPacT INS/INV320/400/500/630)

#### Dimensions

#### Front-panel cutout

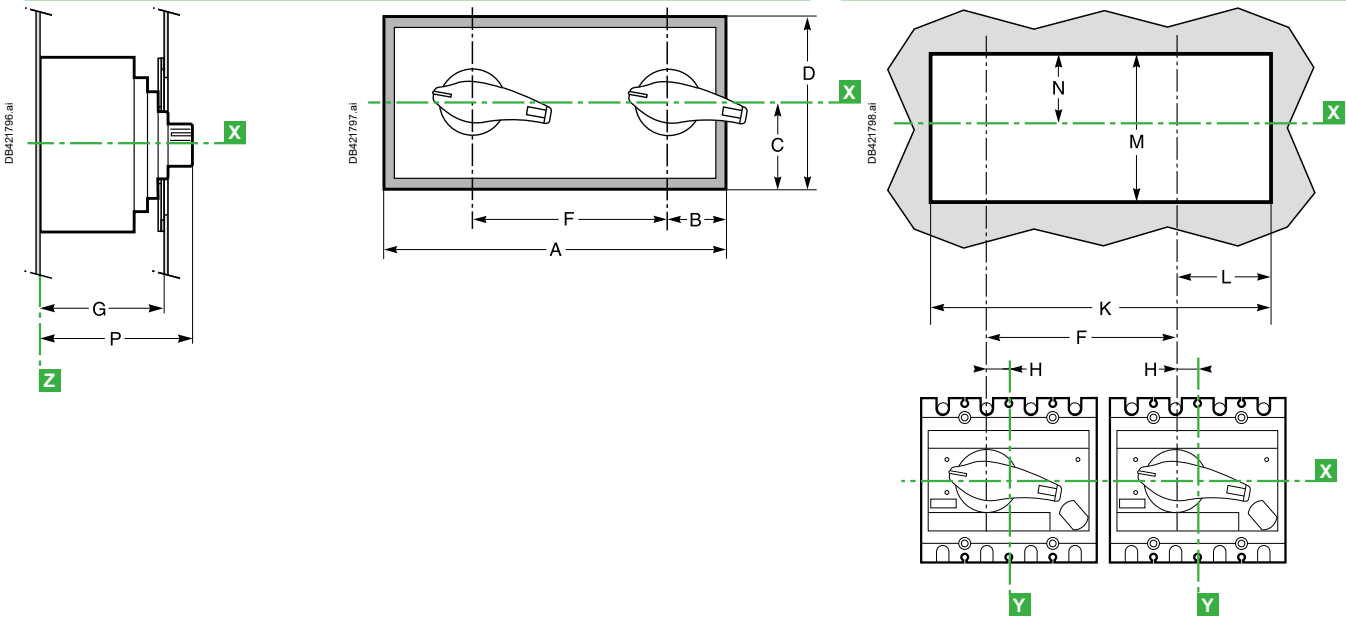

#### Dimensions (mm)

Type	A	B	C	D	F	G	H	K	L	M	N	P
INS/INV250 - 100 to 250 A	325	90	87.5	175	156	106	17.5	295	75.5	150	75	131
INS/INV320/400/500/630	416	115	100	200	210	130	22.5	386	100	175	74.5	160.4

Note: X and Y are the symmetry planes for a 3-pole device.

#### Interlocking of extended rotary handles

(ComPacT INS40/63/80/100/125/160 / ComPacT INS/INV250 - 100 to 250 A / ComPacT INS/INV320/400/500/630)

#### Dimensions

#### Front-panel cutout

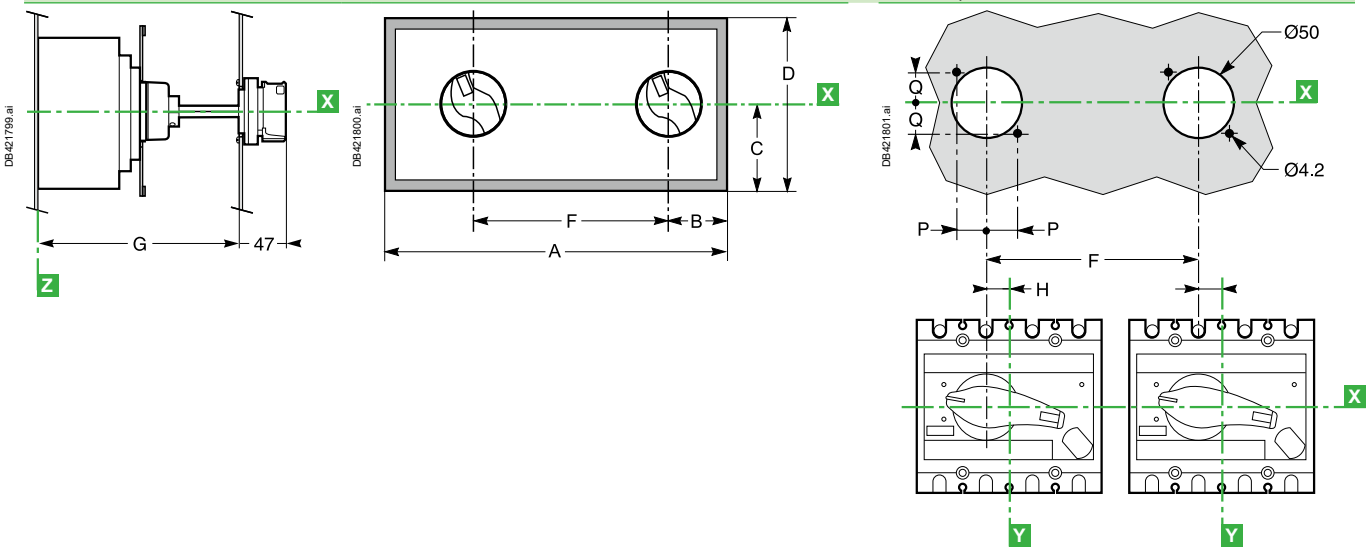

#### Dimensions (mm)

Type	A	B	C	D	F	G min	G max	H	P	Q
INS40/63/80	325	90	87.5	175	156	155	396	0	25.5	25.5
INS100/125/160	325	90	87.5	175	156	200	441	0	25.5	25.5
INS/INV250 - 100 to 250 A	325	90	87.5	175	156	185	600	17.5	25.5	25.5
INS320/400/500/630	416	115	100	200	210	204	600	22.5	30.8	30.8

# Manual source-changeover systems

## ComPacT NSX

Class PC and CB

### Interlocking of direct rotary handles (ComPacT NSX100 to NSX630 and ComPacT NSX100 NA to NSX630 NA)

Dimensions

Front-panel cutout

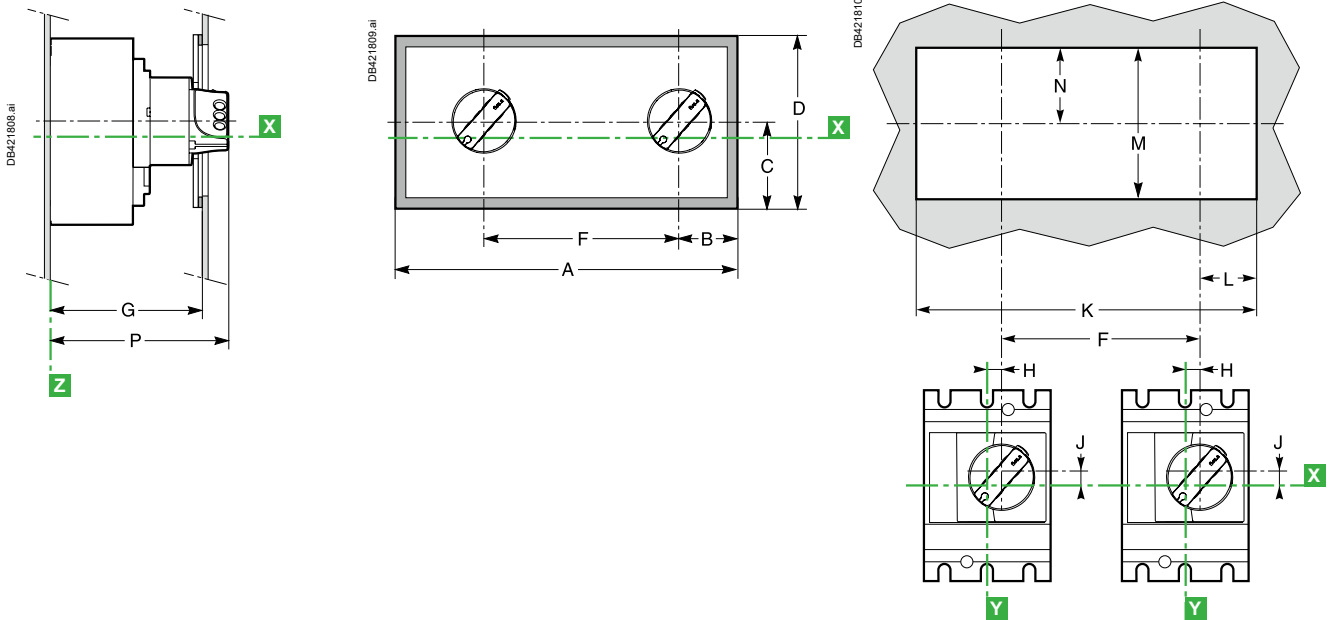

Dimensions (mm)

	A	B	C	D	F	G	H	J	K	L	M	N	P
NSX100/160/250 and NA	325	90	87.5	175	156	133	9.25	9	295	75.5	150	75	155
NSX400/630 and NA	416	115	100	200	210	157	5	24.6	386	100	175	74.5	179

### Interlocking of extended rotary handles (ComPacT NSX100 to NSX630 and ComPacT NSX100 NA to NSX630 NA)

Dimensions

Front-panel cutout

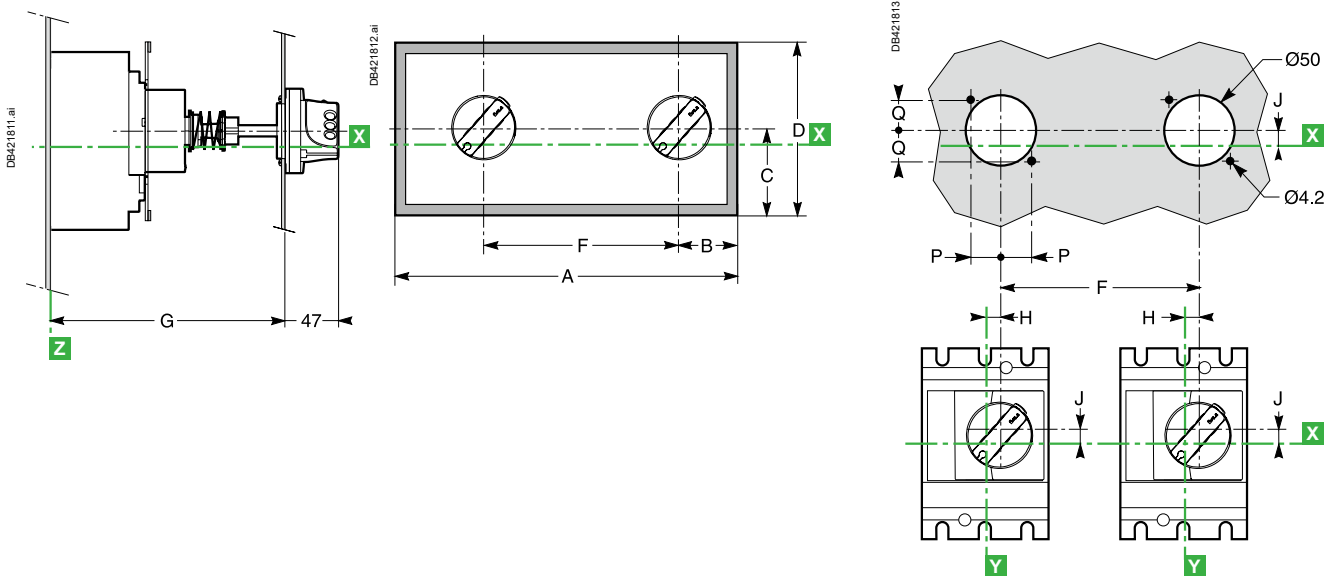

Dimensions (mm)

Type	A	B	C	D	F	G min	G max	H	J	P	Q
NSX100/160/250 and NA	325	90	87.5	175	156	171	600	9.25	9	25.5	25.5
NSX400/630 and NA	416	115	100	200	210	195	600	5	24.6	30.8	30.8



# Manual source-changeover systems

## ComPacT NSX

Class PC and CB

### Interlocking of toggles (ComPacT NSX100 to NSX630 and ComPacT NSX100 NA to NSX630 NA)

#### Dimensions 3 poles 4 poles

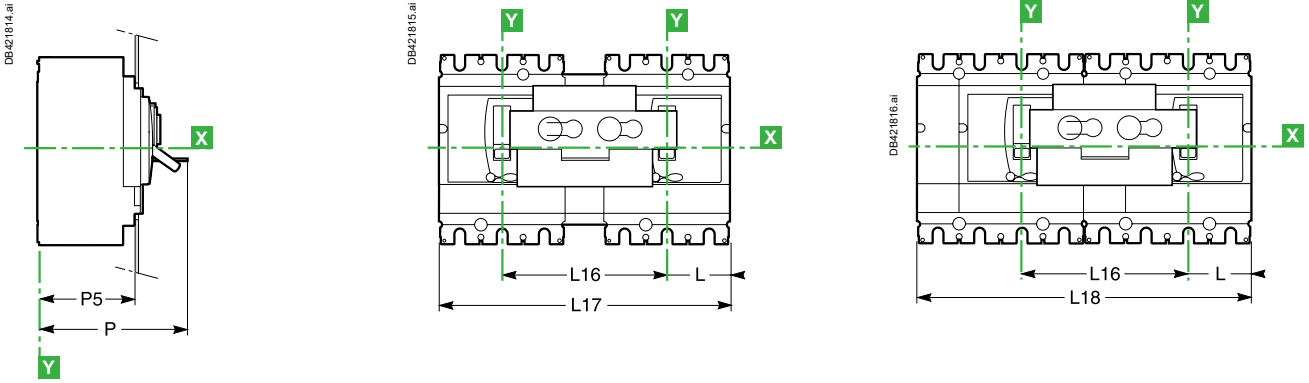

#### Front-panel cutout 3 poles on left 4 poles on left

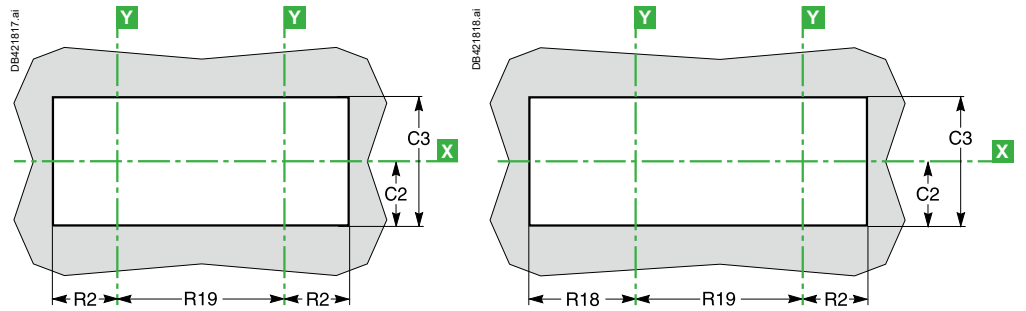

Dimensions (mm)

Type	C2	C3	L	L16	L17	L18	R2	R18	R19	P5	P
NSX100/160/250 and NA	54	108	52.5	140	245	280	54	89	140	83	120
NSX400/630 and NA	92.5	182	70	185	325	370	71.5	116.5	185	107	150

# Manual source-changeover systems

## ComPacT NSX - Interlocking on a base plate

Class PC and CB

### ComPacT NSX100 to NSX250 and ComPacT NSX100 NA to NSX250 NA

Dimensions, 3 or 4 poles      Fixed device      Withdrawable device

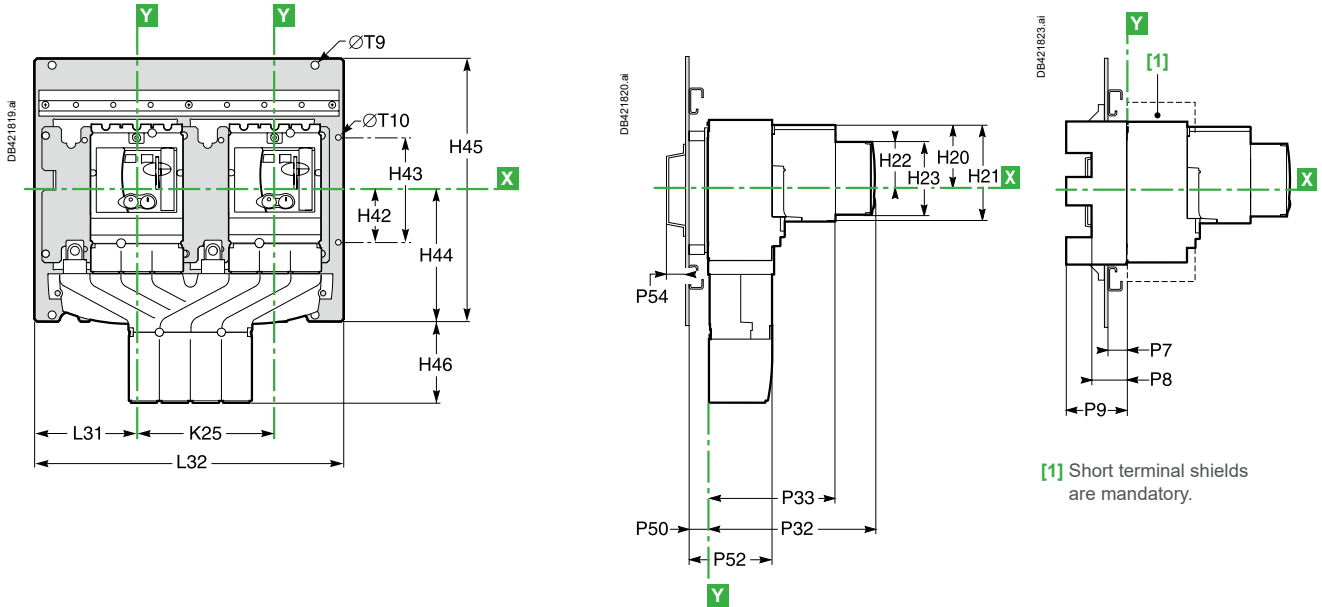

[1] Short terminal shields are mandatory.

Vertical mounting      Horizontal mounting

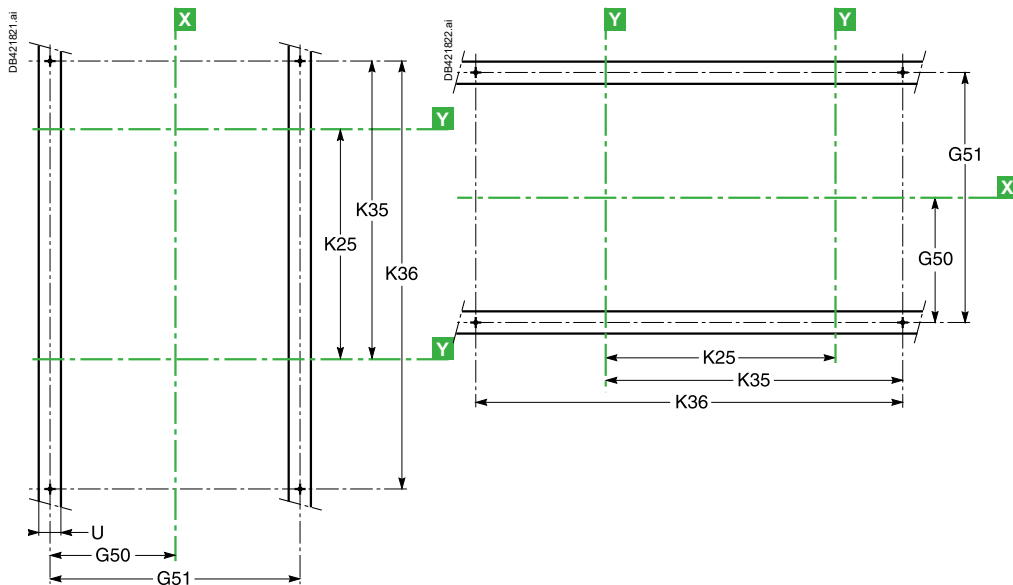

Dimensions (mm)														
Type	G50	G51	H20	H21	H22	H23	H42	H43	H44	H45	H46	K25	K35	K36
NSX100/160/250 and NA	137.5	285	62.5	97	45.5	73	60	120	144.5	300	37	156	210.5	300
NSX400/630 and NA	180	360	100	152	83	123	60	120	189	378	77	210	282.5	400

Dimensions (mm)													
Type	L31	L32	P7	P8	P9	P32	P33	P50	P52	P54	ØT9	ØT10	U
NSX100/160/250 and NA	110.5	354	25	45	75	182	143	25	99.5	21	9	6	≤ 32
NSX400/630 and NA	150.5	466	25	45	100	256	215	25	123	21	9	6	≤ 32

Note: coupling accessory: only for changeover systems using fixed versions of ComPacT NSX circuit breakers.



# Manual source-changeover systems

## ComPacT NSX - Interlocking on a base plate

### Class PC and CB

#### ComPacT NSX400 to NSX630 and ComPacT NSX400 NA to NSX630 NA

#### Dimensions, 3 or 4 poles

#### Fixed device

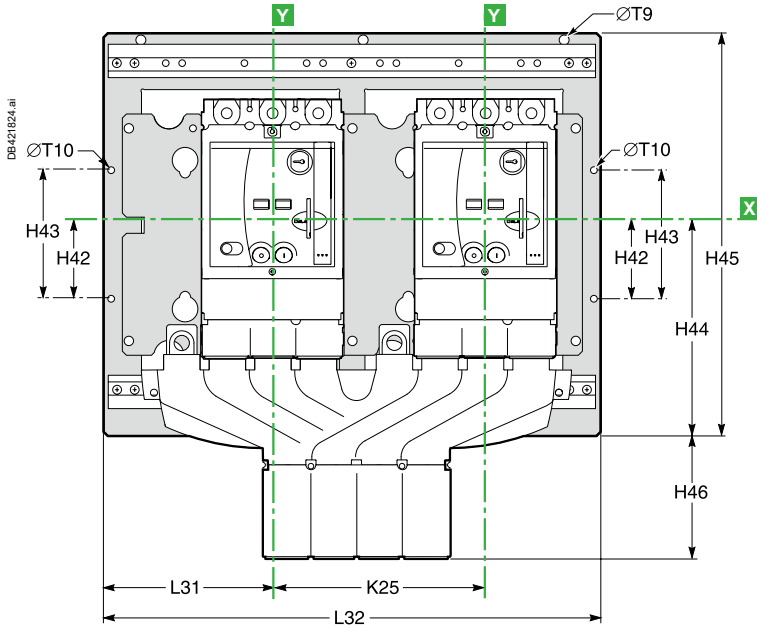

**Note:** coupling accessory: only for changeover systems using fixed versions of ComPacT NSX circuit breakers.

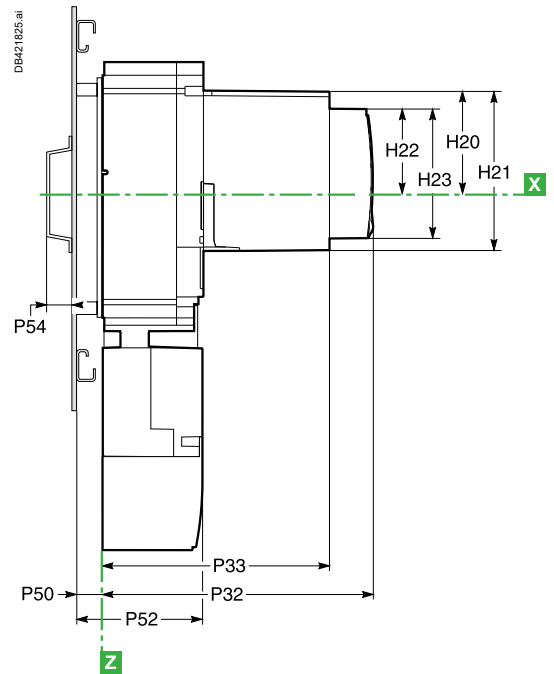

#### Vertical mounting

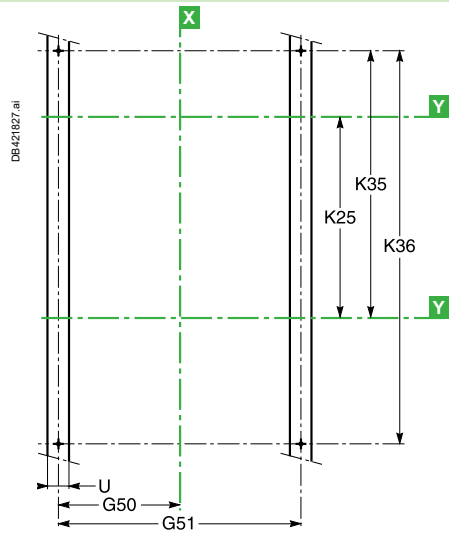

#### Withdrawable device

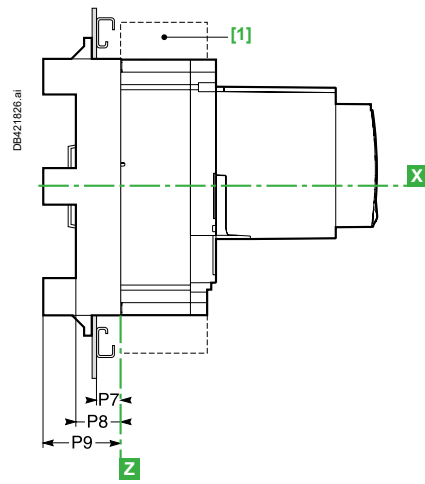

[1] Short terminal shields are mandatory.

#### Horizontal mounting

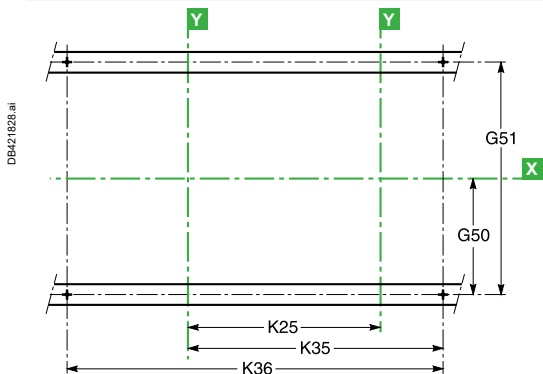

**Note:** for dimensions see page C-22.

# Manual source-changeover systems

## ComPacT NSX - Interlocking on a base plate

Class PC and CB

**“Normal” and “Replacement” source devices: NSX100 to NSX250**

**Dimensions Front-panel cutout**

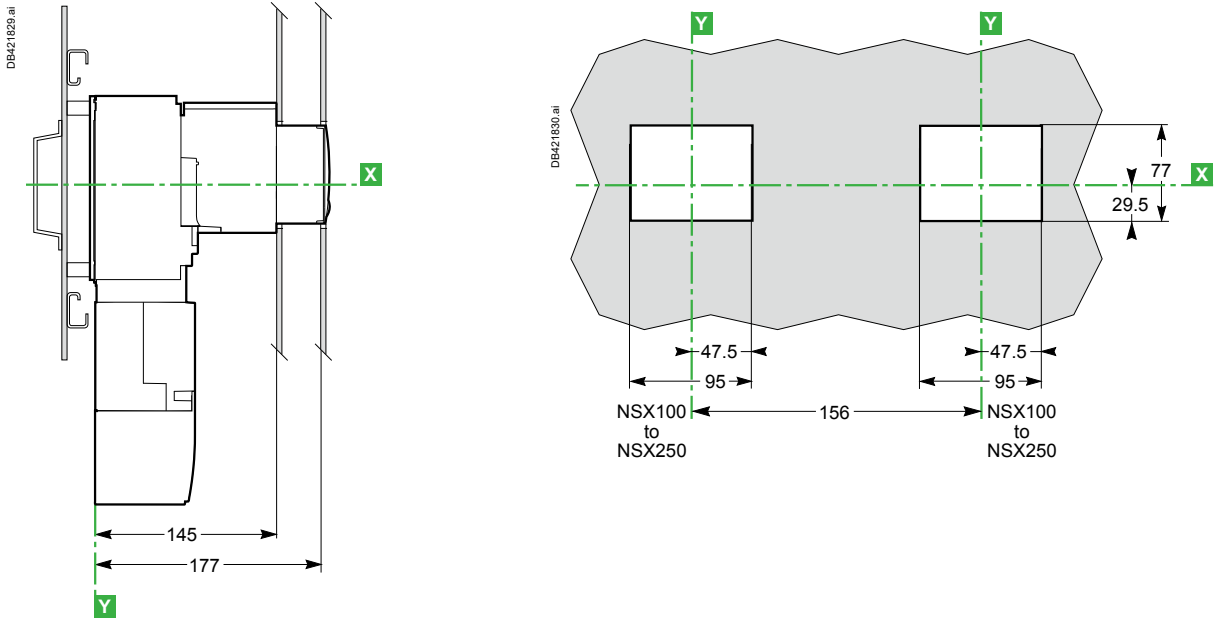

**“Normal” and “Replacement” source devices: NSX400 to NSX630**

**Dimensions Front-panel cutout**

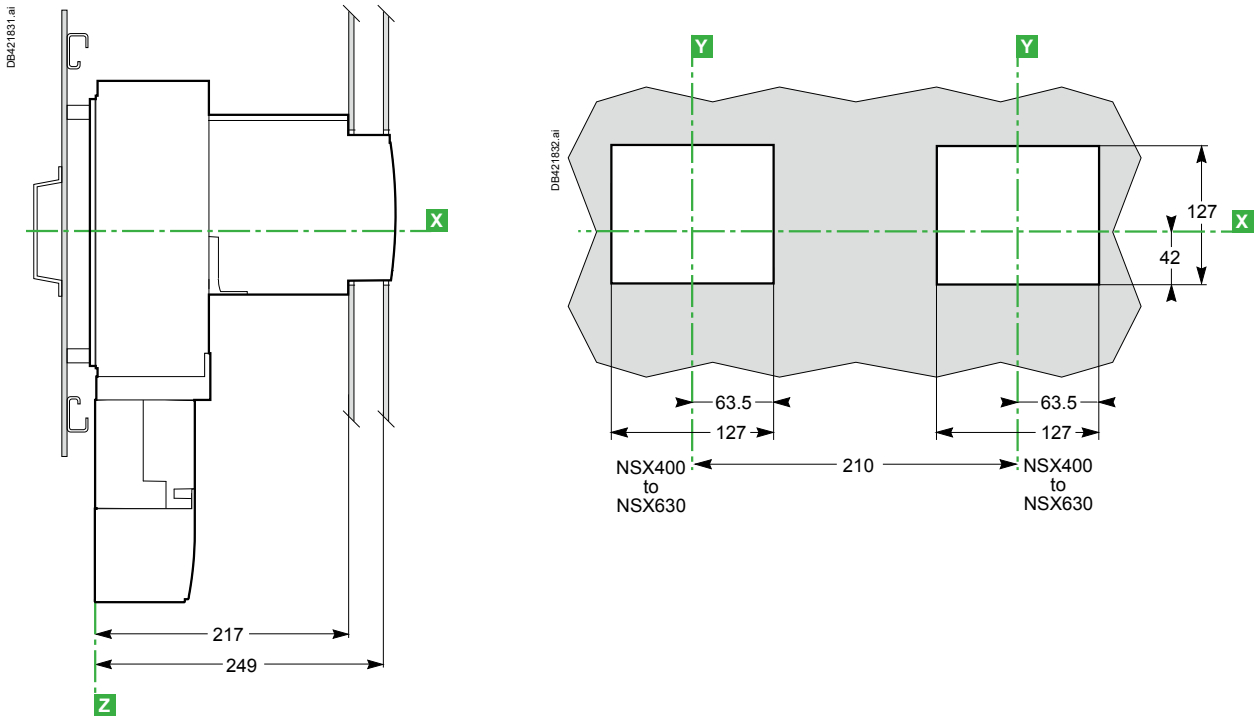

**Note for ComPacT NSX:** For dimensions with the accessories (IP40 escutcheons and Vigi escutcheon protection collars), see Catalog ComPacT.



# Manual source-changeover systems

## ComPacT NSX - Interlocking on a base plate

### Class PC and CB

NSX400 to NSX630 as the "Normal" device, NSX100 to NSX250 as the "Replacement" device

Dimensions

Front-panel cutout

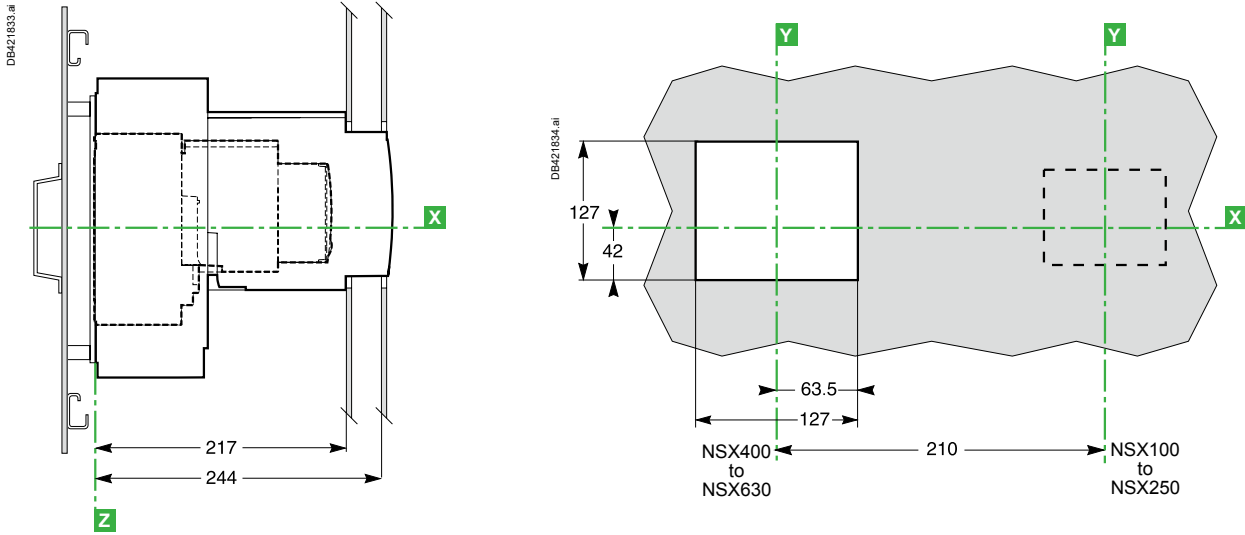





# Manual source-changeover systems

## ComPacT NS - Interlocking on a base plate

Class PC and CB

Interlocking of extended rotary handles

ComPacT NS630b to 1600 and ComPacT NS630b NA to NS1600 NA

Dimensions

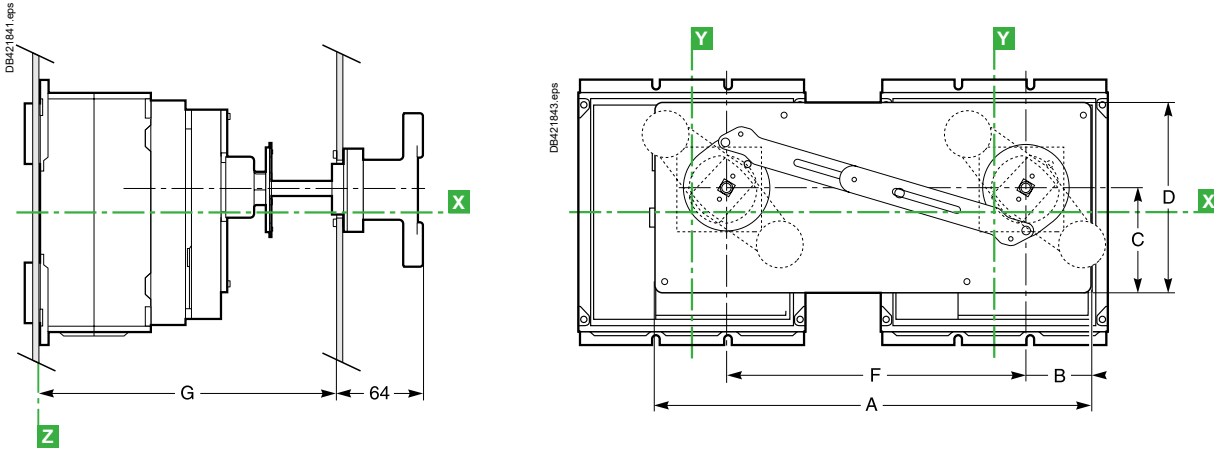

### Front-panel cutout

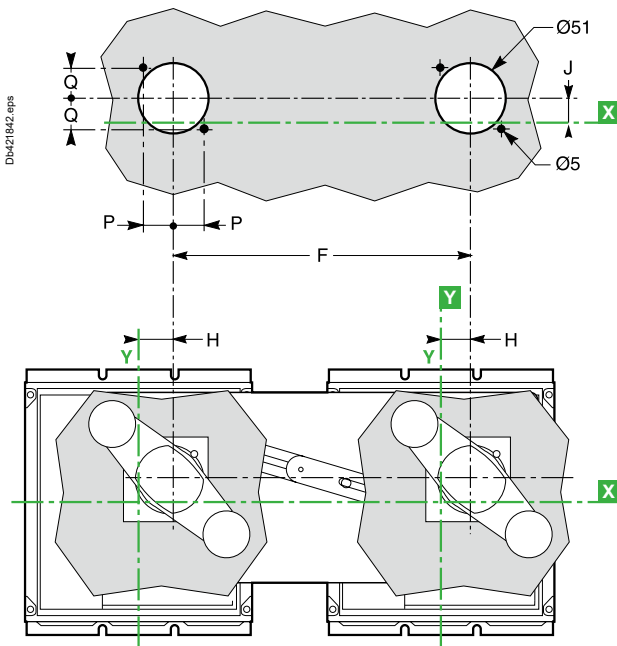

### Dimensions (mm)

Type	A	B	C	D	F	G min	G max	H	J	P	Q	R
NS630b/800/1000/1200/1600	411	63.5	98	175	280	218	605	25	24	25.5	25.5	64

# Source-changeover systems

## Mechanical interlocking using connecting rods

ComPacT NS and MasterPacT MTZ1  
Class PC and CB

ComPacT NS630b to NS1600 and ComPacT NS630b NA to NS1600 NA  
devices one above the other

Fixed devices Withdrawable devices

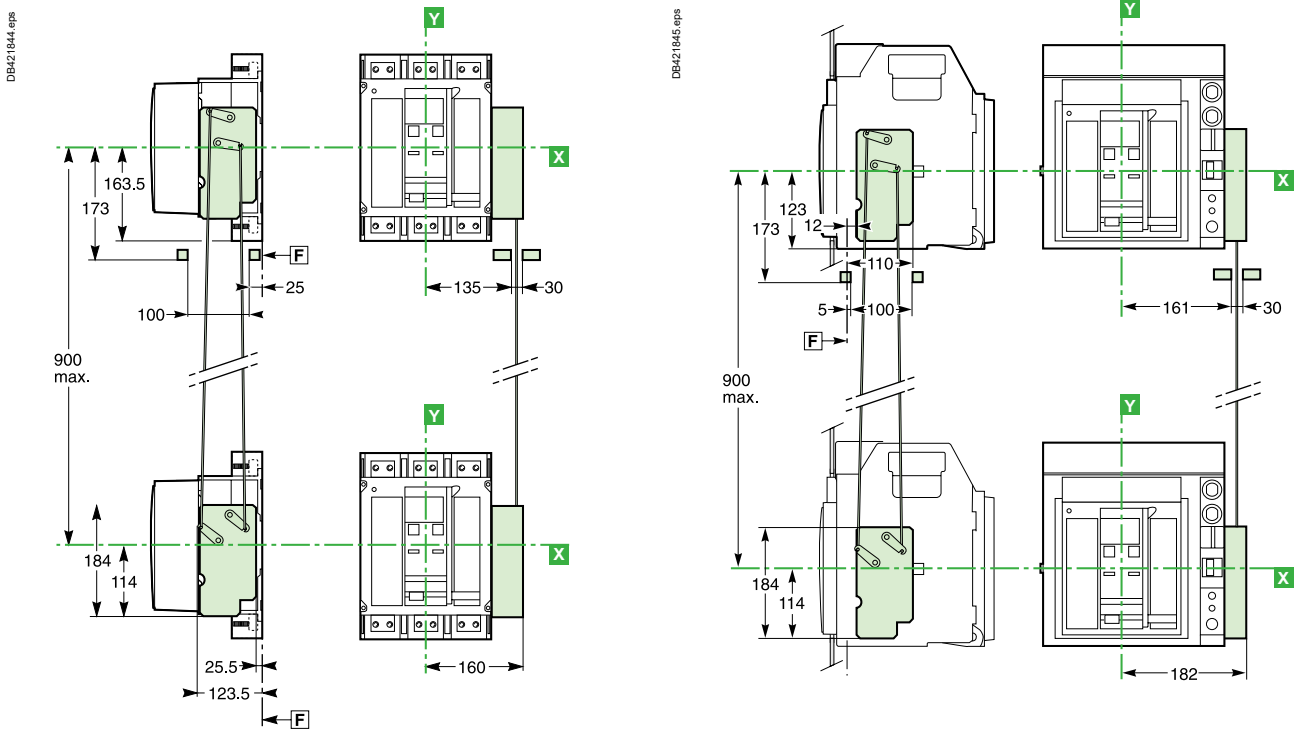

Two MasterPacT MTZ1 devices (switch-disconnectors or circuit breakers)  
one above the other

Fixed devices Withdrawable devices

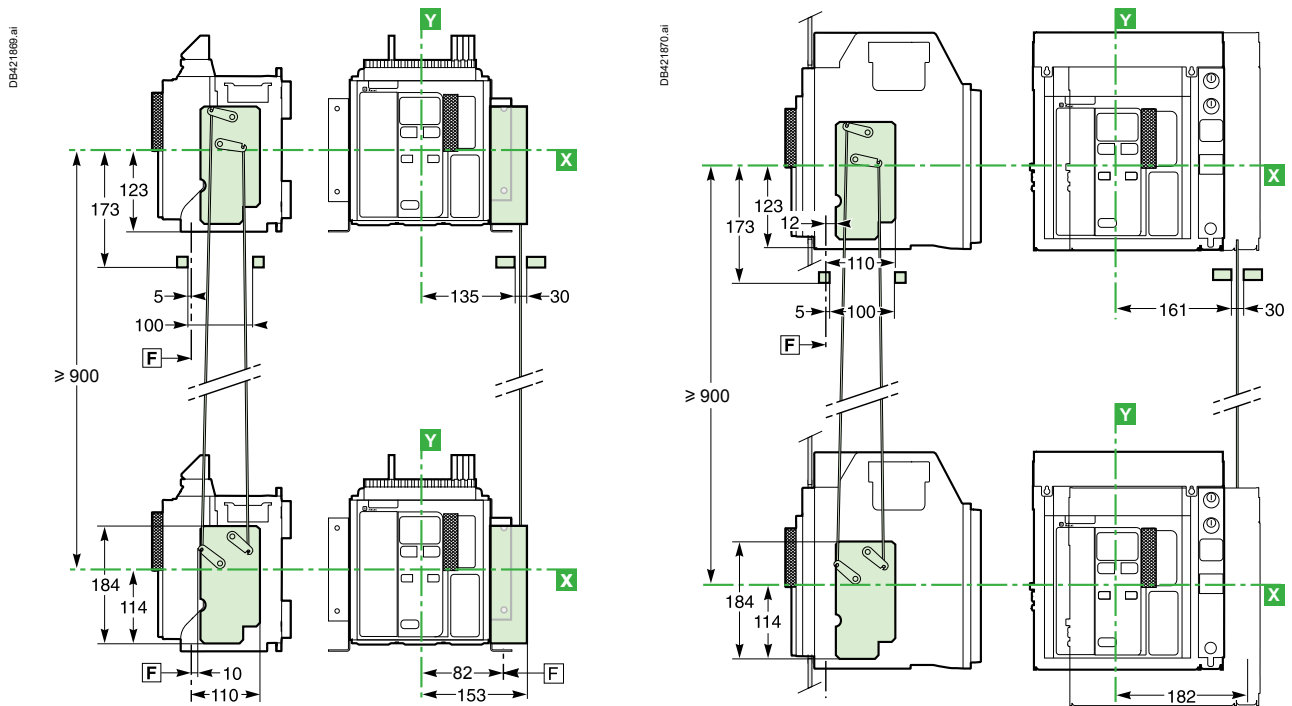



# Source-changeover systems

Mechanical interlocking using connecting cables

ComPacT NS and MasterPacT MTZ1/MTZ2/MTZ3

Class PC and CB

## ComPacT NS630b to NS1600 and ComPacT NS630b NA to NS1600 NA devices side-by-side

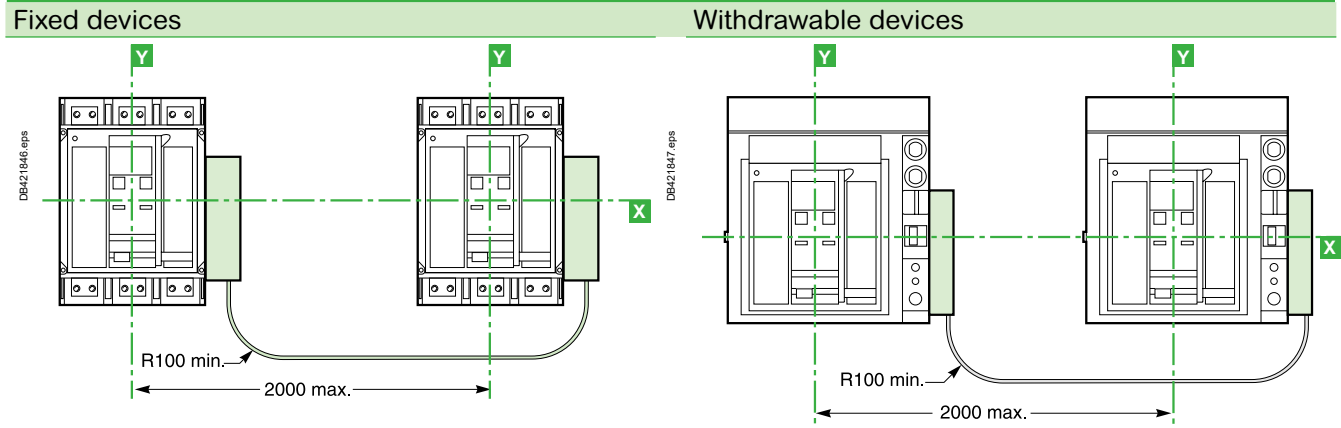

## Two MasterPacT MTZ1 devices (switch-disconnectors or circuit breakers) side-by-side

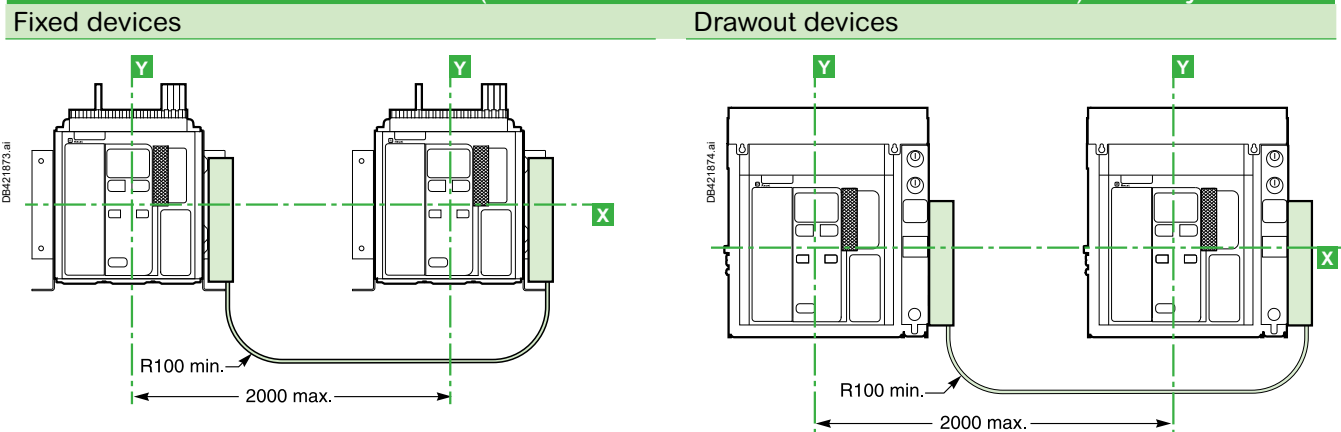

## Combination of two MasterPacT MTZ1 and MTZ2/MTZ3 devices (switch-disconnectors or circuit breakers) side-by-side

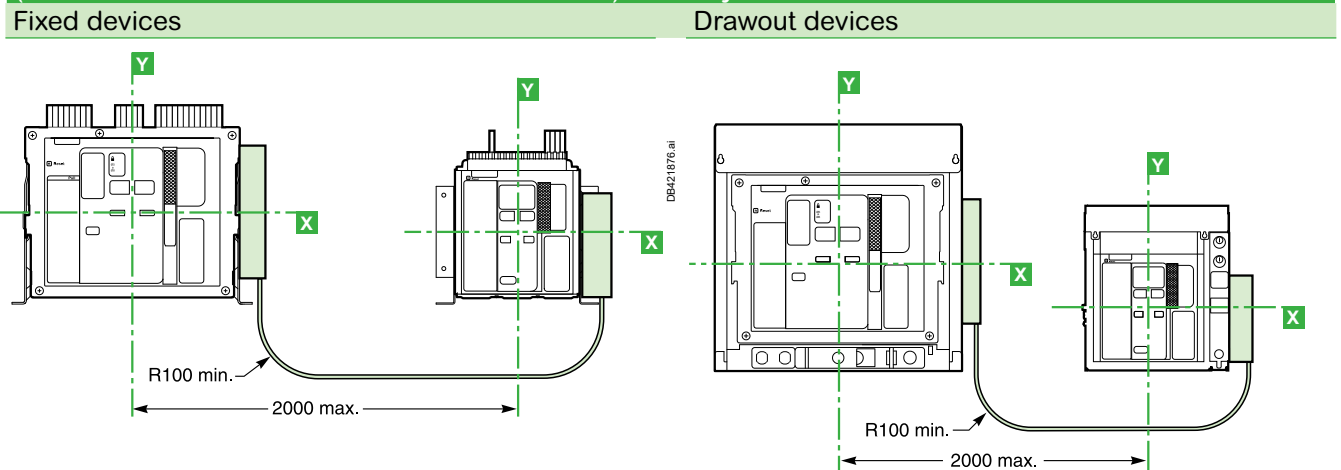





# Source-changeover systems

Mechanical interlocking using connecting cables

MasterPacT MTZ2/MTZ3

Class PC and CB

## Two MasterPacT MTZ2/MTZ3 devices side-by-side

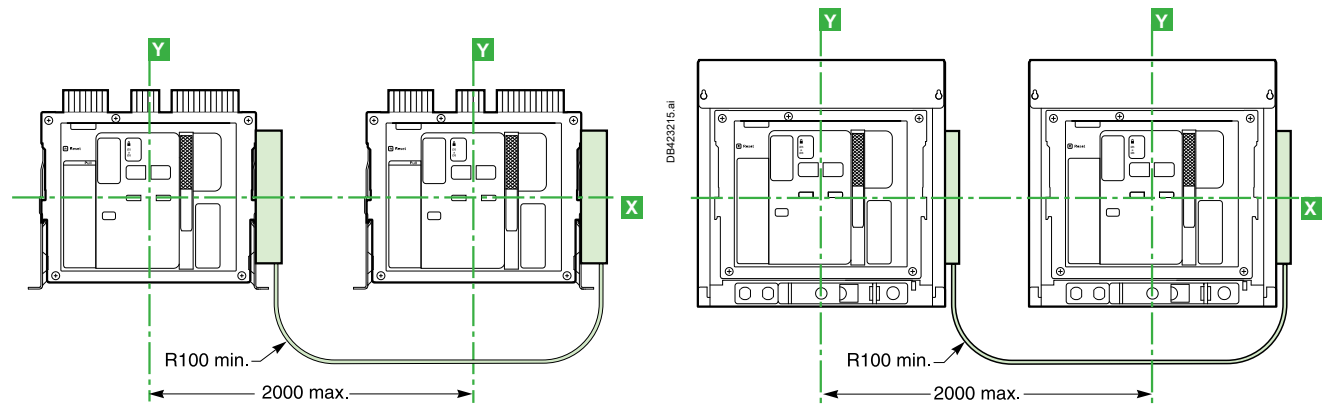

## Three MasterPacT MTZ2/MTZ3 devices (switch-disconnectors or circuit breakers) side-by-side

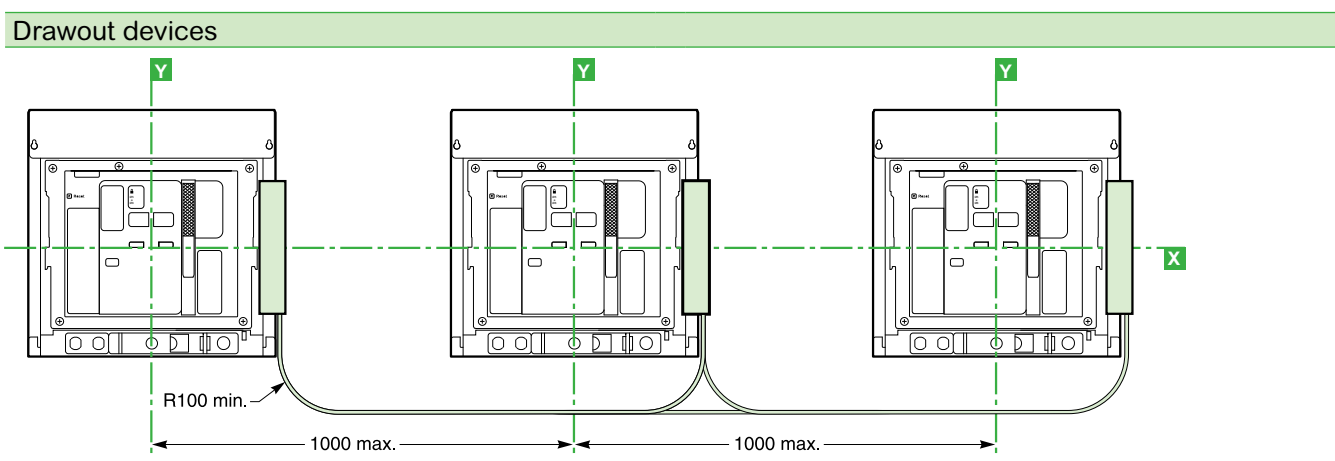
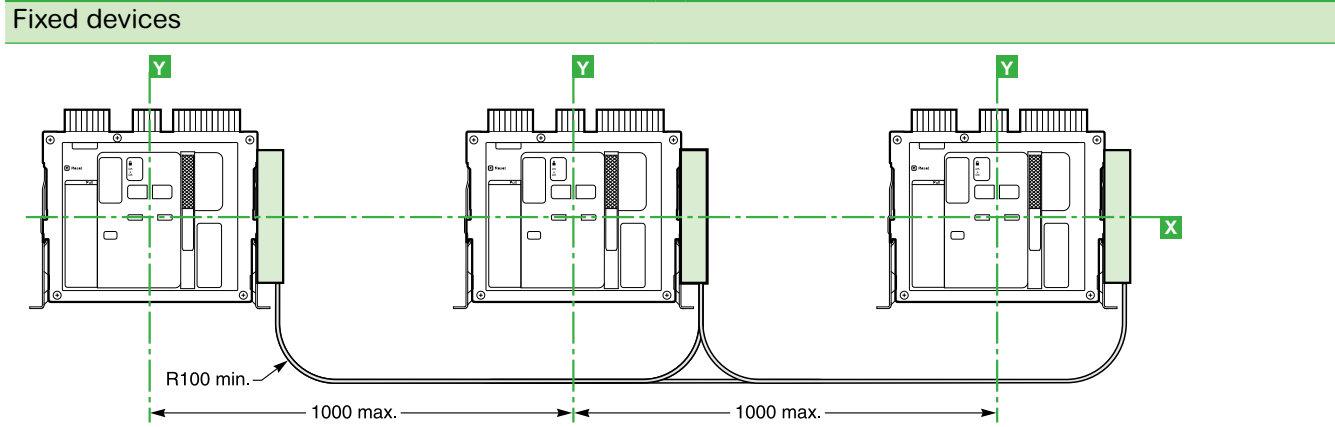



# Source-changeover systems

Mechanical interlocking using connecting cables

MasterPacT MTZ2/MTZ3

Class PC and CB

Three MasterPacT MTZ2/MTZ3 devices (switch-disconnectors or circuit breakers) one above the other

Fixed devices

Drawout devices

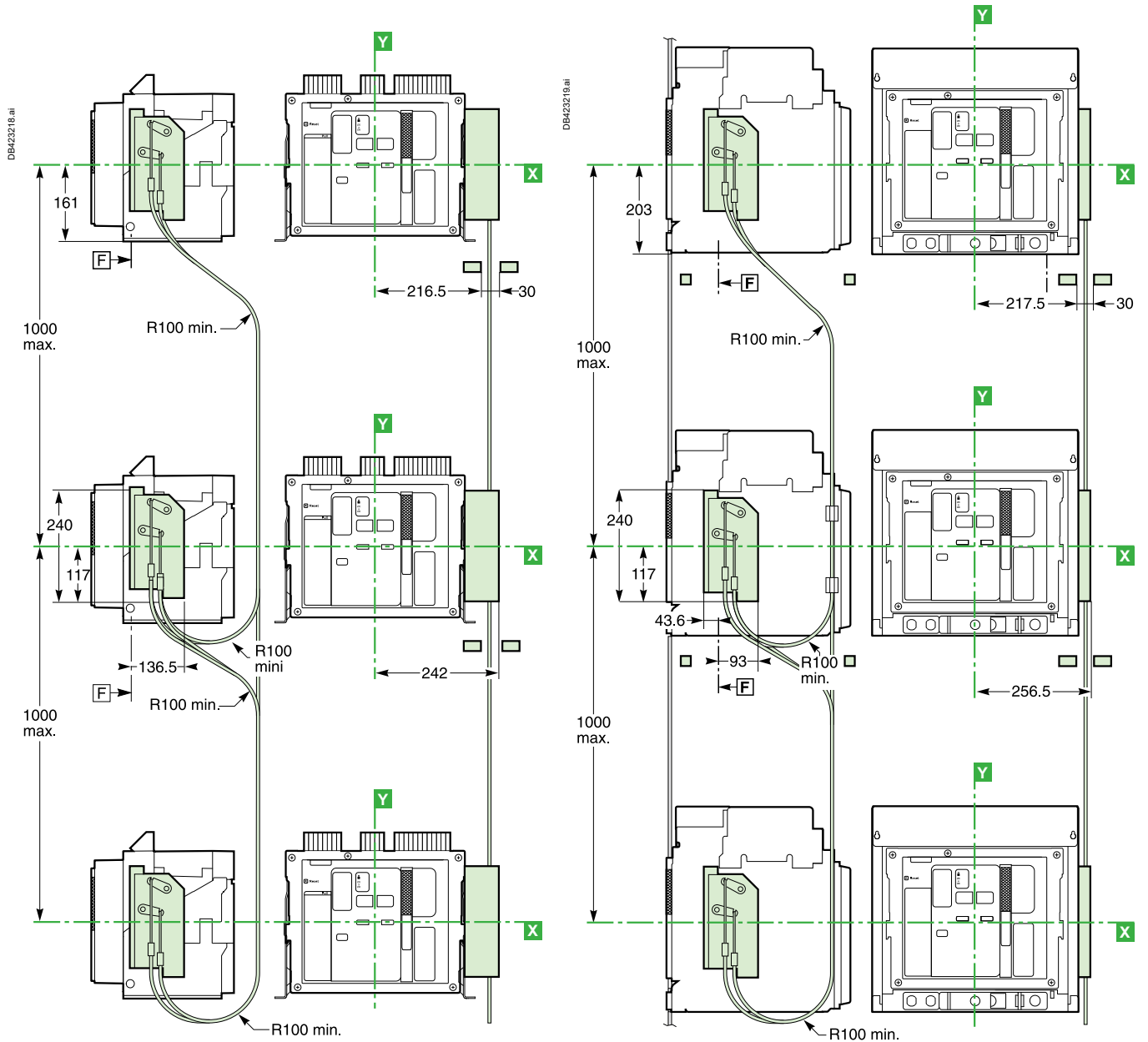

# TransferPacT

## IVE unit, UA/BA controllers

### IVE unit

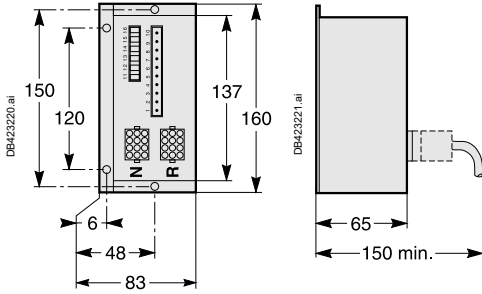

### UA/BA controllers

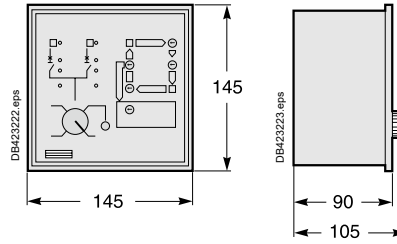

### ACP control plate and UA/BA controllers

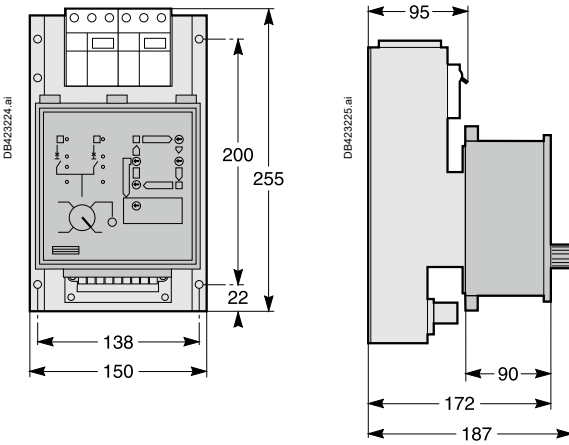

### Door cutout for UA/BA controllers

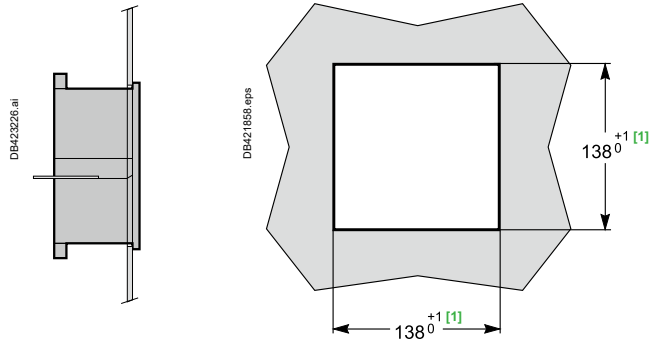

[1] Cutout according to DIN 43700 standard.

# Standard configurations

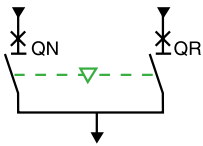
ComPacT NS, MasterPacT MTZ1 and MTZ2/MTZ3												
Types of mechanical interlocking	Possible combinations	Typical electrical diagrams	Diagram no.	Page								
<p>2 devices</p>  <p>DB4421850.eps</p>	<table border="1"> <thead> <tr> <th>QN</th> <th>QR</th> </tr> </thead> <tbody> <tr> <td>0</td> <td>0</td> </tr> <tr> <td>1</td> <td>0</td> </tr> <tr> <td>0</td> <td>1</td> </tr> </tbody> </table>	QN	QR	0	0	1	0	0	1	<p><b>ComPacT NSX100 to 630:</b></p> <ul style="list-style-type: none"> <li>■ Electrical interlocking without emergency power off (EPO) auxiliaries:                             <ul style="list-style-type: none"> <li><input type="checkbox"/> With EPO by MN <b>51201177</b> C-39</li> <li><input type="checkbox"/> With EPO by MN <b>51201178</b> C-40</li> <li><input type="checkbox"/> With EPO by MX <b>51201179</b> C-41</li> </ul> </li> </ul> <p><b>ComPacT NS630b to 1600:</b></p> <ul style="list-style-type: none"> <li>■ Electrical interlocking with lockout after fault:                             <ul style="list-style-type: none"> <li><input type="checkbox"/> Permanent replacement source (with IVE) <b>51201183</b> C-42</li> <li><input type="checkbox"/> With emergency off by shunt release MX (with IVE) <b>51201184</b> C-43</li> <li><input type="checkbox"/> With emergency off by undervoltage release MN (with IVE) <b>51201185</b> C-44</li> </ul> </li> </ul> <p><b>MasterPacT MTZ1 and MTZ2/3:</b></p> <ul style="list-style-type: none"> <li>■ Electrical interlocking with lockout after fault:                             <ul style="list-style-type: none"> <li><input type="checkbox"/> Permanent replacement source (with IVE) C-11</li> <li><input type="checkbox"/> With EPO by MX (with IVE) C-12</li> <li><input type="checkbox"/> With EPO by MN (with IVE) C-13</li> </ul> </li> <li>■ Automatic control with lockout after fault:                             <ul style="list-style-type: none"> <li><input type="checkbox"/> permanent replacement source (with IVE) C-14</li> <li><input type="checkbox"/> engine generator set (with IVE) C-15</li> </ul> </li> </ul>		
QN	QR											
0	0											
1	0											
0	1											



# Standard configurations

MasterPacT MTZ2/MTZ3 only																								
Types of mechanical interlocking	Possible combinations	Typical electrical diagrams	Page																					
<b>3 devices: 2 "Normal" sources and 1 "Replacement" source</b>																								
<p>DB421859.eps</p>	<table border="1"> <thead> <tr> <th>QN1</th> <th>QN2</th> <th>QR</th> </tr> </thead> <tbody> <tr> <td>0</td> <td>0</td> <td>0</td> </tr> <tr> <td>1</td> <td>1</td> <td>0</td> </tr> <tr> <td>0</td> <td>0</td> <td>1</td> </tr> </tbody> </table>	QN1	QN2	QR	0	0	0	1	1	0	0	0	1	<ul style="list-style-type: none"> <li>■ Electrical interlocking:                             <ul style="list-style-type: none"> <li><input type="checkbox"/> Without lockout after fault</li> <li><input type="checkbox"/> With lockout after fault</li> </ul> </li> </ul>	<p>C-19</p> <p>C-20</p>									
	QN1	QN2	QR																					
	0	0	0																					
	1	1	0																					
0	0	1																						
<b>3 devices: 2 "Normal" sources and 1 "Replacement" source with source selection</b>																								
<p>DB421860.eps</p>	<table border="1"> <thead> <tr> <th>QN1</th> <th>QN2</th> <th>QR</th> </tr> </thead> <tbody> <tr> <td>0</td> <td>0</td> <td>0</td> </tr> <tr> <td>1</td> <td>0</td> <td>0</td> </tr> <tr> <td>0</td> <td>0</td> <td>1</td> </tr> <tr> <td>1</td> <td>1</td> <td>0</td> </tr> <tr> <td>0</td> <td>1</td> <td>0</td> </tr> </tbody> </table>	QN1	QN2	QR	0	0	0	1	0	0	0	0	1	1	1	0	0	1	0	<ul style="list-style-type: none"> <li>■ Automatic control with engine generator set:                             <ul style="list-style-type: none"> <li><input type="checkbox"/> Without lockout after fault (with MN)</li> <li><input type="checkbox"/> With lockout after fault (with MN)</li> </ul> </li> </ul>	<p>C-21</p> <p>C-22</p>			
	QN1	QN2	QR																					
	0	0	0																					
	1	0	0																					
	0	0	1																					
1	1	0																						
0	1	0																						
<b>3 devices: 3 sources, only one device</b>																								
<p>DB421861.eps</p>	<table border="1"> <thead> <tr> <th>QS1</th> <th>QS2</th> <th>QS3</th> </tr> </thead> <tbody> <tr> <td>0</td> <td>0</td> <td>0</td> </tr> <tr> <td>1</td> <td>0</td> <td>0</td> </tr> <tr> <td>0</td> <td>1</td> <td>0</td> </tr> <tr> <td>0</td> <td>0</td> <td>1</td> </tr> </tbody> </table>	QS1	QS2	QS3	0	0	0	1	0	0	0	1	0	0	0	1	<ul style="list-style-type: none"> <li>■ Electrical interlocking:                             <ul style="list-style-type: none"> <li><input type="checkbox"/> Without lockout after fault</li> <li><input type="checkbox"/> With lockout after fault</li> </ul> </li> </ul>	<p>C-23</p> <p>C-24</p>						
	QS1	QS2	QS3																					
	0	0	0																					
	1	0	0																					
0	1	0																						
0	0	1																						
<b>3 devices: 2 sources + 1 coupling</b>																								
<p>DB421862.eps</p>	<table border="1"> <thead> <tr> <th>QS1</th> <th>QC</th> <th>QS2</th> </tr> </thead> <tbody> <tr> <td>0</td> <td>0</td> <td>0</td> </tr> <tr> <td>1</td> <td>0</td> <td>1</td> </tr> <tr> <td>1</td> <td>1</td> <td>0</td> </tr> <tr> <td>0</td> <td>1</td> <td>1</td> </tr> <tr> <td>1</td> <td>0</td> <td>0</td> </tr> <tr> <td>0</td> <td>0</td> <td>1</td> </tr> </tbody> </table>	QS1	QC	QS2	0	0	0	1	0	1	1	1	0	0	1	1	1	0	0	0	0	1	<ul style="list-style-type: none"> <li>■ Electrical interlocking:                             <ul style="list-style-type: none"> <li><input type="checkbox"/> Without lockout after fault</li> <li><input type="checkbox"/> With lockout after fault</li> </ul> </li> <li>■ Automatic control with lockout after fault</li> </ul>	<p>C-25</p> <p>C-26</p> <p>C-27</p>
	QS1	QC	QS2																					
	0	0	0																					
	1	0	1																					
	1	1	0																					
	0	1	1																					
1	0	0																						
0	0	1																						
<p>[1] possible by forcing operation</p>																								

"Lockout after fault" option. This option makes it necessary to manually reset the device following fault tripping.

# Remote-operated source-changeover systems

2 ComPacT NSX100/630, NS630b/1600

or MasterPacT MTZ1/MTZ2/MTZ3 devices

## Electrical interlocking by the IVE unit

### Independent order to Normal/Replacement source

### Simultaneous order to Normal/Replacement source

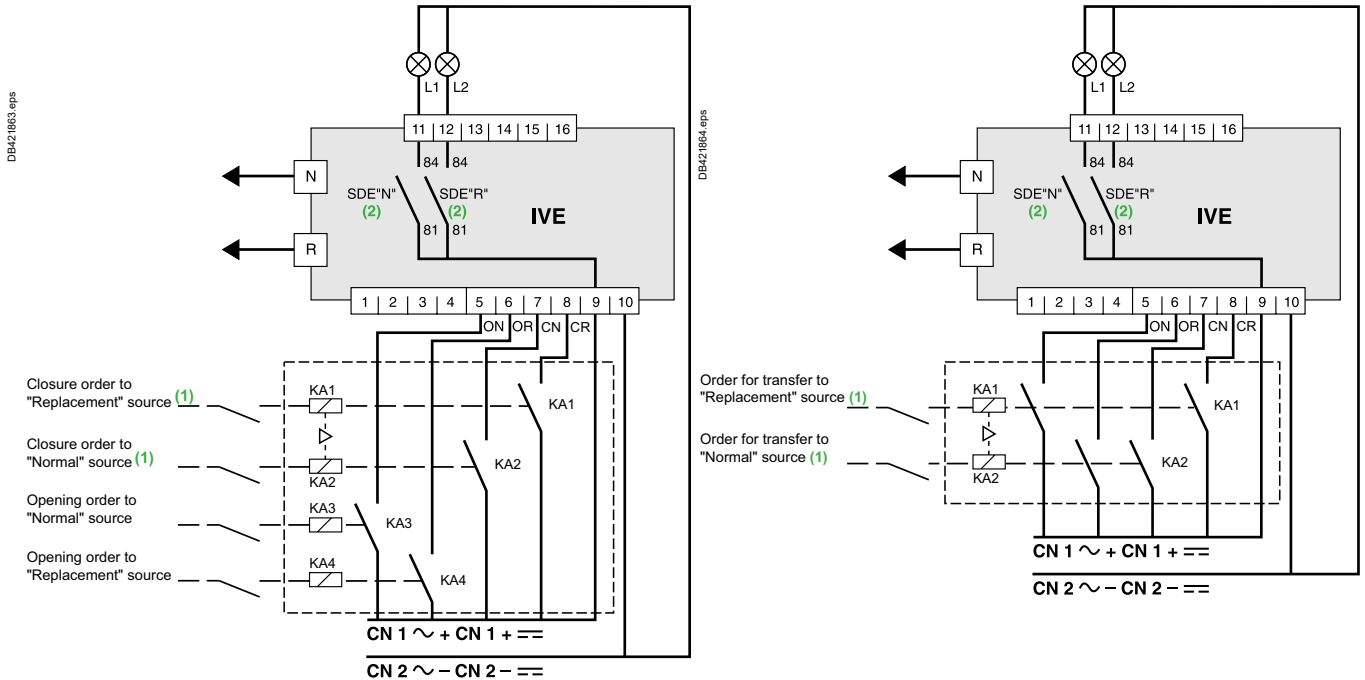

Controlling each circuit breaker independently.

Control of two circuit breakers by “common” transfer order.

[1] See section “IMPORTANT” here after.

[2] Operating diagram: the SDE “fault-trip” signals are transmitted to the IVE unit. The SDE auxiliary contacts are mounted in the circuit breakers.

### IMPORTANT

The relays controlling the closing order to the “Normal” and “Replacement” circuit breakers must be mechanically and/or electrically interlocked to prevent them from giving simultaneous closing commands.

It is recommended to use **Tesys K** relays from Schneider Electric reference LC2-K06010●●. These relays are mechanically and electrically interlocked.

#### Legends

- ON “Normal” source opening order
- OR “Replacement” source opening order
- CN “Normal” source closing order
- CR “Replacement” source closing order
- KA1 auxiliary relay
- KA2 auxiliary relay
- KA3 auxiliary relay
- KA4 auxiliary relay
- L1 “Normal” source “fault-trip” signal
- L2 “Replacement” source “fault-trip” signal
- N “Normal” source auxiliary wiring connector
- R “Replacement” source auxiliary wiring connector

**Note:** diagram shown with circuits de-energized, circuit breakers open and relays in normal position.

# Remote-operated source-changeover systems

2 ComPacT NSX100/630 devices

Diagram no. 51201177

## Source-changeover system without automatic-control system

Without auxiliaries for emergency off

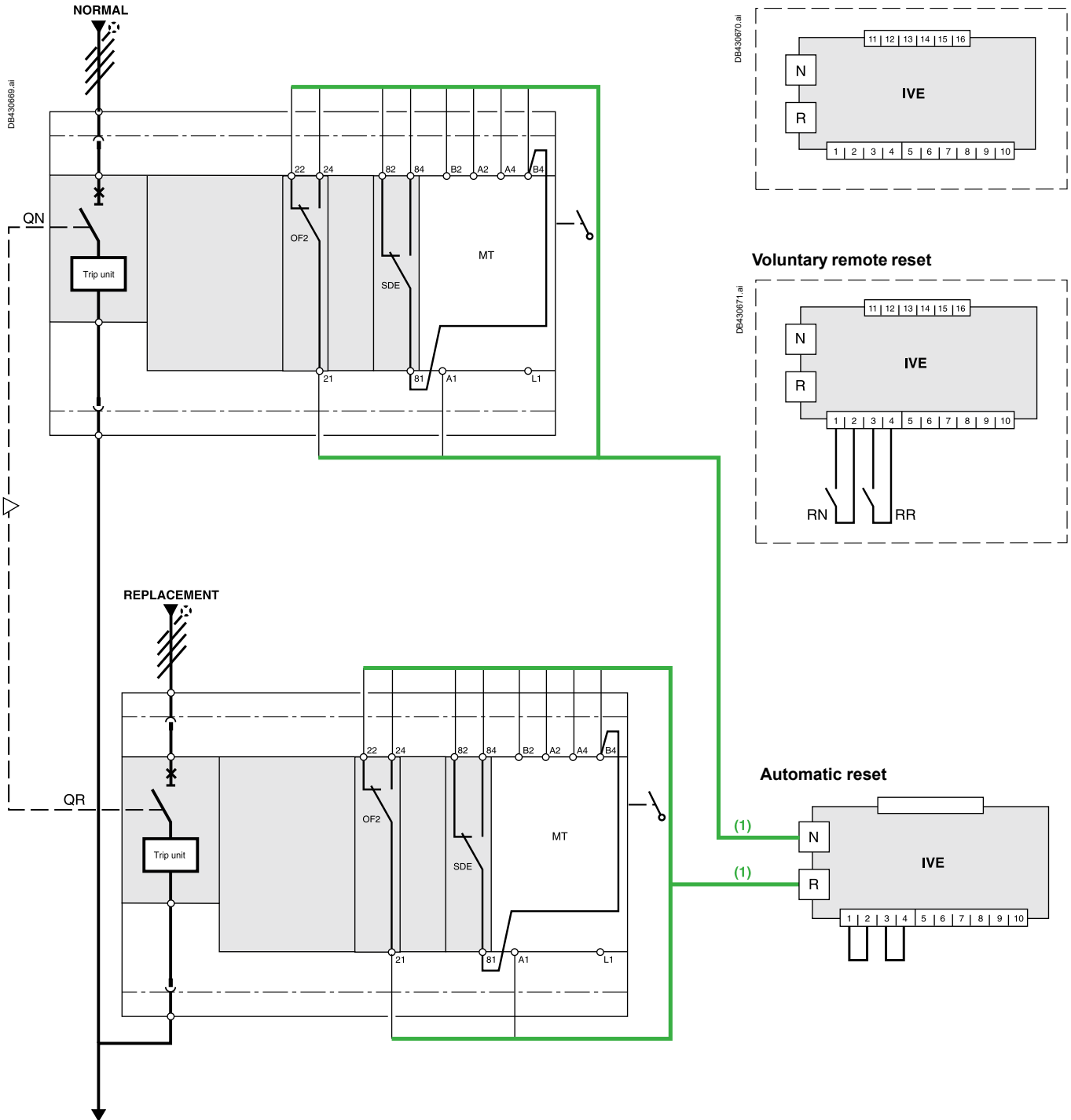

### Local reset

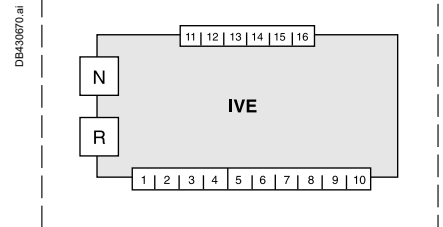

### Voluntary remote reset

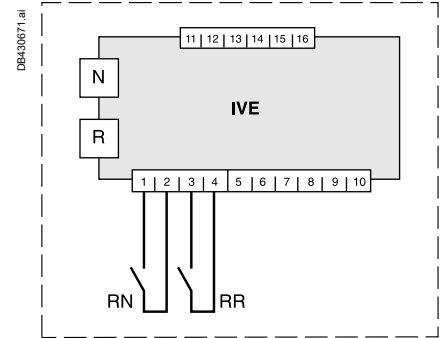

### Automatic reset

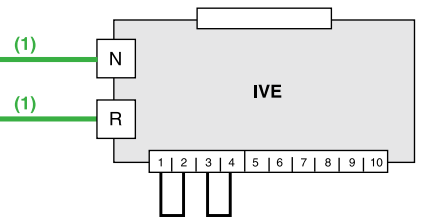

### Legends

- QN "Normal" source ComPacT NSX equipped with motor mechanism
- QR "Replacement" source ComPacT NSX equipped with motor mechanism
- SDE "fault-trip" indication contact
- IVE electrical interlocking and terminal block unit
- MT motor mechanism
- OF2 breaker ON/OFF indication contact
- RN reset order for breaker QN
- RR reset order for breaker QR

[1] Prefabricated wiring: cannot be modified.

### States permitted by mechanical interlocking system

Normal	Replacement
0	0
1	0
0	1

Note: diagram shown with circuits de-energized, circuit breakers open and relays in normal position.

# Remote-operated source-changeover systems

2 ComPacT NSX100/630 devices

Diagram no. 51201178

**Source-changeover system without automatic-control system**  
**With emergency off by MN release and automatic reset**

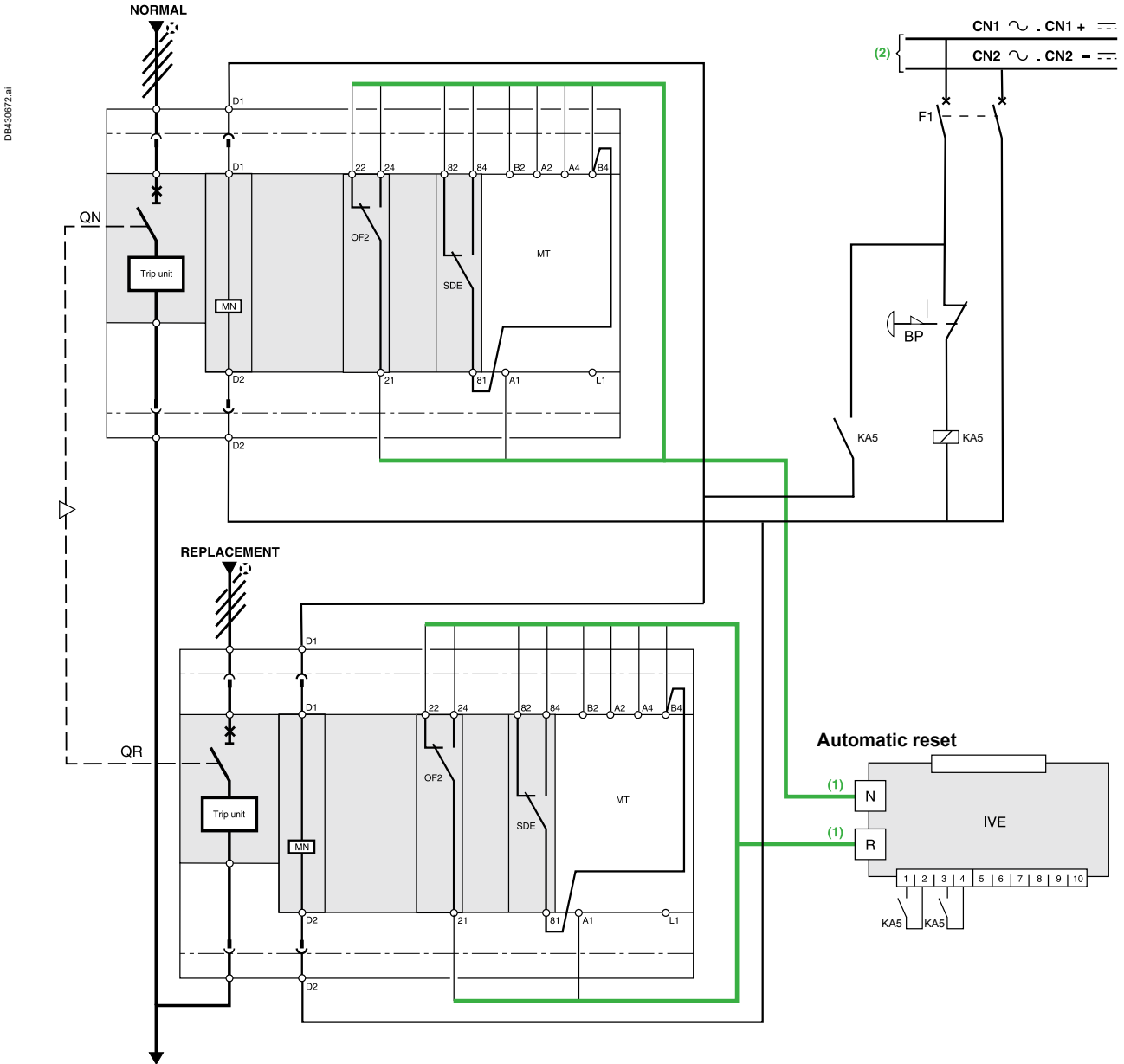

- [1] Prefabricated wiring supplied.
- [2] Independent auxiliary source.

**Legends**

- Q1 "Normal" source ComPacT NSX equipped with motormechanism
- Q2 "Replacement" source ComPacT NSX equipped with motor mechanism
- MN undervoltage release
- OF2 breaker ON/OFF indication contact
- SDE "fault-trip" indication contact
- MT motor mechanism
- IVE electrical interlocking and terminal block unit
- BP emergency off button with latching
- KA5 auxiliary relay
- F1 auxiliary power supply circuit breaker

**States permitted by mechanical interlocking system**

Normal	Replacement
0	0
1	0
0	1

**Note:** after a fault trip, the breaker must be reset manually by pressing its reset button.  
 Diagram shown with circuits de-energized, circuit breakers open and relays in normal position.



# Remote-operated source-changeover systems

## 2 ComPacT NSX100/630 devices

Diagram no. 51201179

### Source-changeover system without automatic-control system

With emergency off by MX release and automatic reset

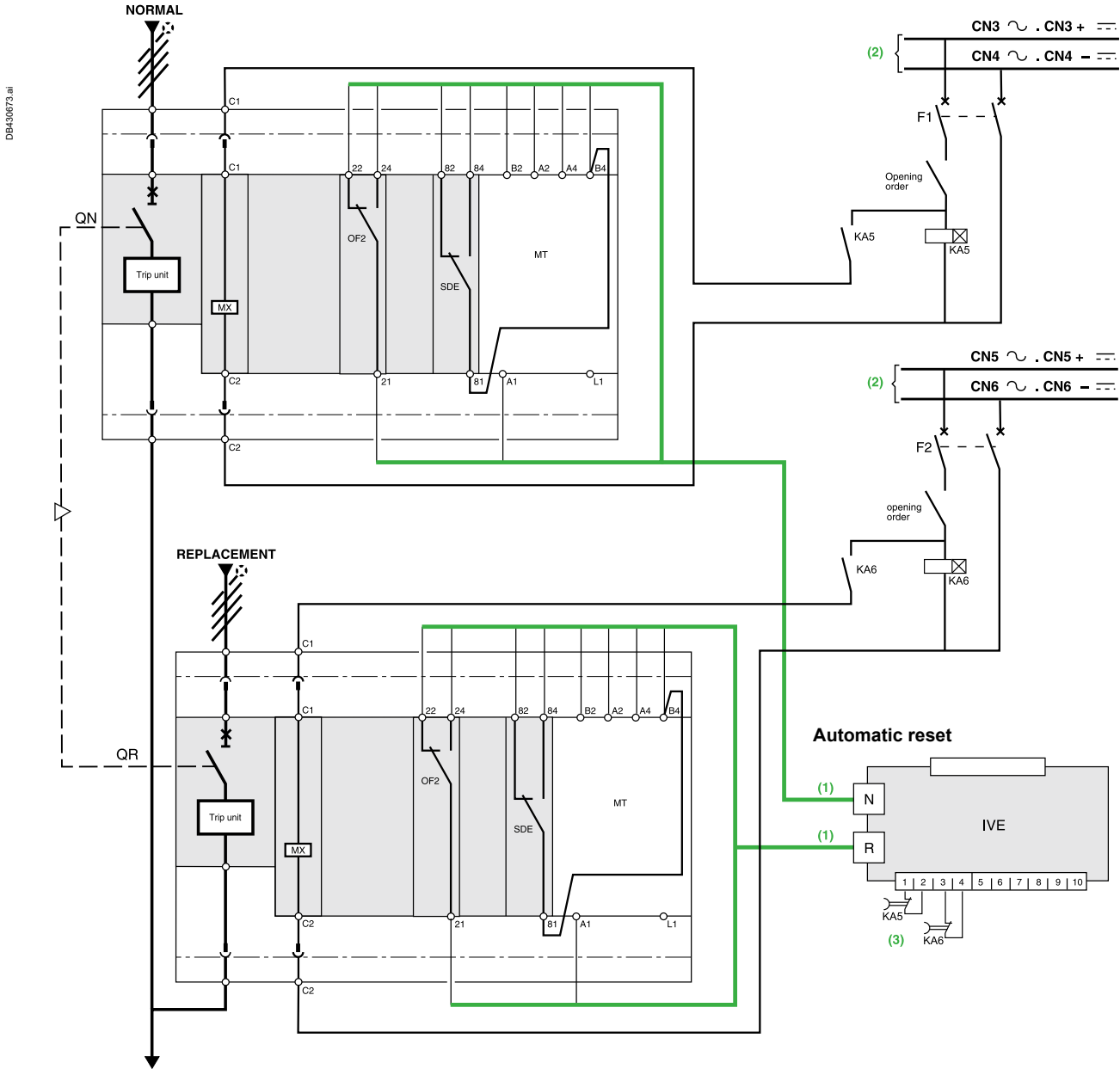

**Legends**

- QN "Normal" source ComPacT NSX equipped with motor mechanism
- QR "Replacement" source ComPacT NSX equipped with motor mechanism
- SDE "fault-trip" indication contact
- OF2 breaker ON/OFF indication contact
- MX shunt release
- MT motor mechanism
- IVE electrical interlocking and terminal block unit
- KA5 time-delayed auxiliary relays
- KA6 time-delayed auxiliary relays
- F1 auxiliary power supply circuit breaker
- F2 auxiliary power supply circuit breaker

- [1] Prefabricated wiring supplied
- [2] This source can be:
  - the source present in the case of voltage monitoring
  - an independent source.
 In this case, the MX release must be protected.
- [3] The reset orders must be delayed by 0.3 seconds.

**States permitted by mechanical interlocking system**

Normal	Replacement
0	0
1	0
0	1

**Note:** after a fault trip, the breaker must be reset manually by pressing its reset button. Diagram shown with circuits de-energized, circuit breakers open and relays in normal position.



# Remote-operated source-changeover systems

## 2 ComPacT NS630b/1600 devices

Diagram no. 51201183

### Electrical interlocking by IVE unit

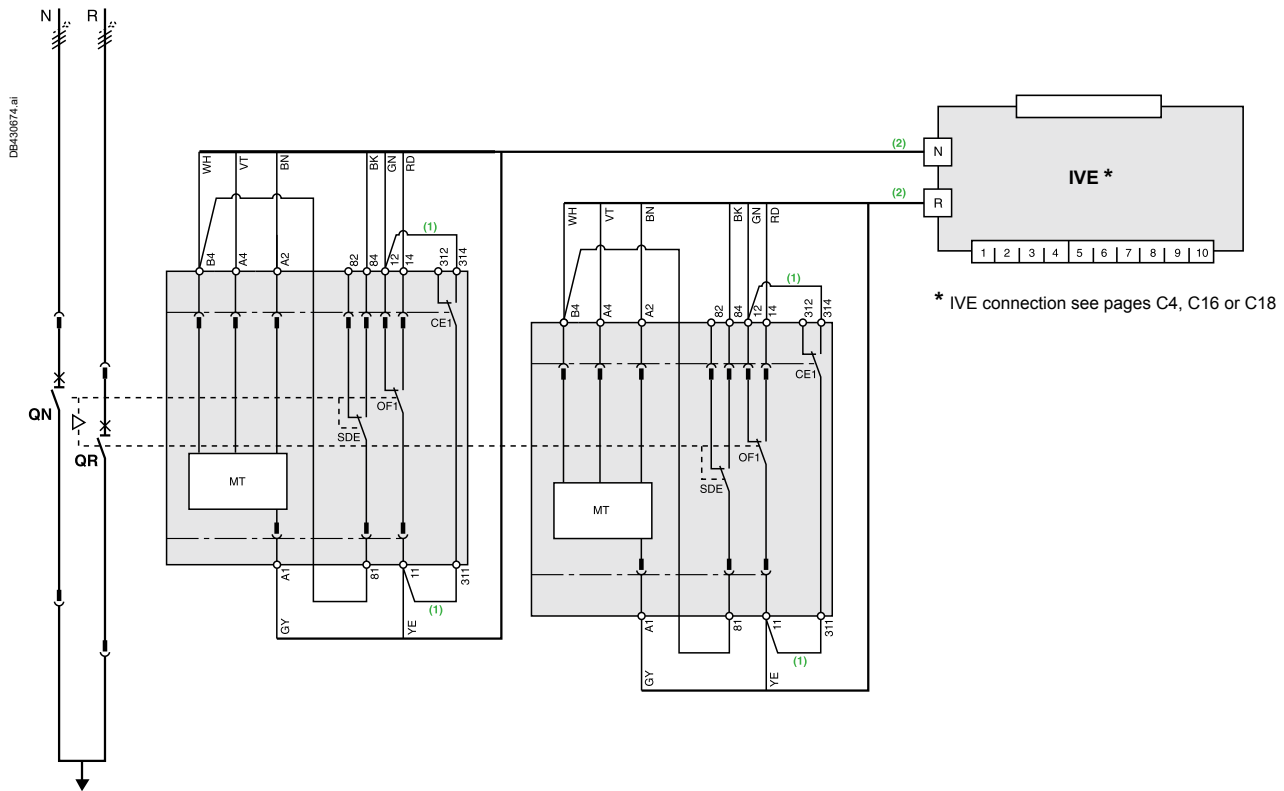

**ATTENTION**  
 The diagram shows the electrical wiring for circuit breakers. When wiring the SDE with **switch-disconnectors**, connect wire **BK** to terminal **82**.

- [1] Not to be wired on fixed version.
- [2] Prefabricated wiring supplied.

**Legends**

- QN "Normal" source ComPacT NS630b to 1600
- QR "Replacement" source ComPacT NS630b to 1600
- OF... breaker ON/OFF indication contact
- SDE "fault-trip" indication contact
- CE1 "connected-position" indication contact (carriage switch)
- F1 auxiliary power supply circuit breaker
- IVE electrical interlocking and terminal block unit
- ON "Normal" source opening order
- OR "Replacement" source opening order
- CN "Normal" source closing order (0.25 second delay)
- CR "Replacement" source closing order (0.25 second delay)
- MT Motor Mechanism

**Wiring colour codes**

RD	GN	BK	VT	YE	GY	WH	BN
red	green	black	violet	yellow	grey	white	brown

**States permitted by mechanical interlocking system**

Normal	Replacement
0	0
1	0
0	1

**Note:** after a fault trip, the breaker must be reset manually by pressing its reset button.  
 Diagram shown with circuit breakers in connected position, open, charged, and ready to close.  
 Auxiliary power supply = supply voltage of auxiliary relays (KA...) = supply voltage of electrical auxiliaries (electrical operation, MT...).



# Remote-operated source-changeover systems

2 ComPacT NS630b/1600 devices

Diagram no. 51201184

**Electrical interlocking by IVE unit with emergency off by shunt release**

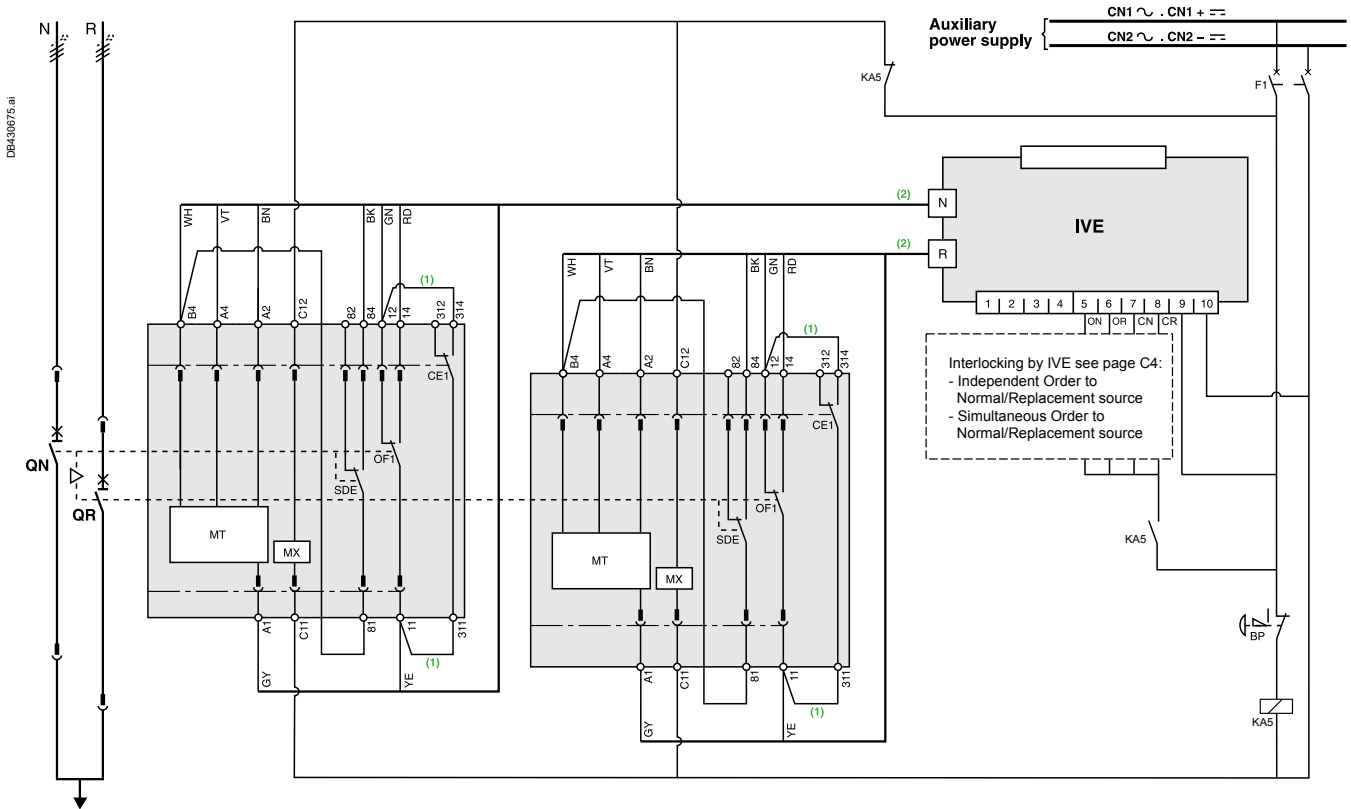

**ATTENTION**  
 The diagram shows the electrical wiring for circuit breakers. When wiring the SDE with switch-disconnectors, connect wire BK to terminal 82.

[1] Not to be wired on fixed version.  
 [2] Prefabricated wiring supplied.

**Legends**

- QN "Normal" source ComPacT NS630b to 1600
- QR "Replacement" source ComPacT NS630b to 1600
- OF... breaker ON/OFF indication contact
- SDE "fault-trip" indication contact
- CE1 "connected-position" indication contact (carriage switch)
- F1 auxiliary power supply circuit breaker
- IVE electrical interlocking and terminal block unit
- MX shunt release
- BP emergency off button with latching
- KA5 auxiliary relay
- ON "Normal" source opening order
- OR "Replacement" source opening order
- CN "Normal" source closing order (0.25 second delay)
- CR "Replacement" source closing order (0.25 second delay)
- MT Motor Mechanism

**Wiring colour codes**

RD	GN	BK	VT	YE	GY	WH	BN
red	green	black	violet	yellow	grey	white	brown

**States permitted by mechanical interlocking system**

Normal	Replacement
0	0
1	0
0	1

**Note:** after a fault trip, the breaker must be reset manually by pressing its reset button.  
 Diagram shown with circuit breakers in connected position, open, charged, and ready to close.  
 Auxiliary power supply = supply voltage of auxiliary relays (KA...) = supply voltage of electrical auxiliaries (electrical operation, MX, MT...).

# Remote-operated source-changeover systems

## 2 ComPacT NS630b/1600 devices

Diagram no. 51201185

**Electrical interlocking by IVE unit with emergency off by undervoltage release**

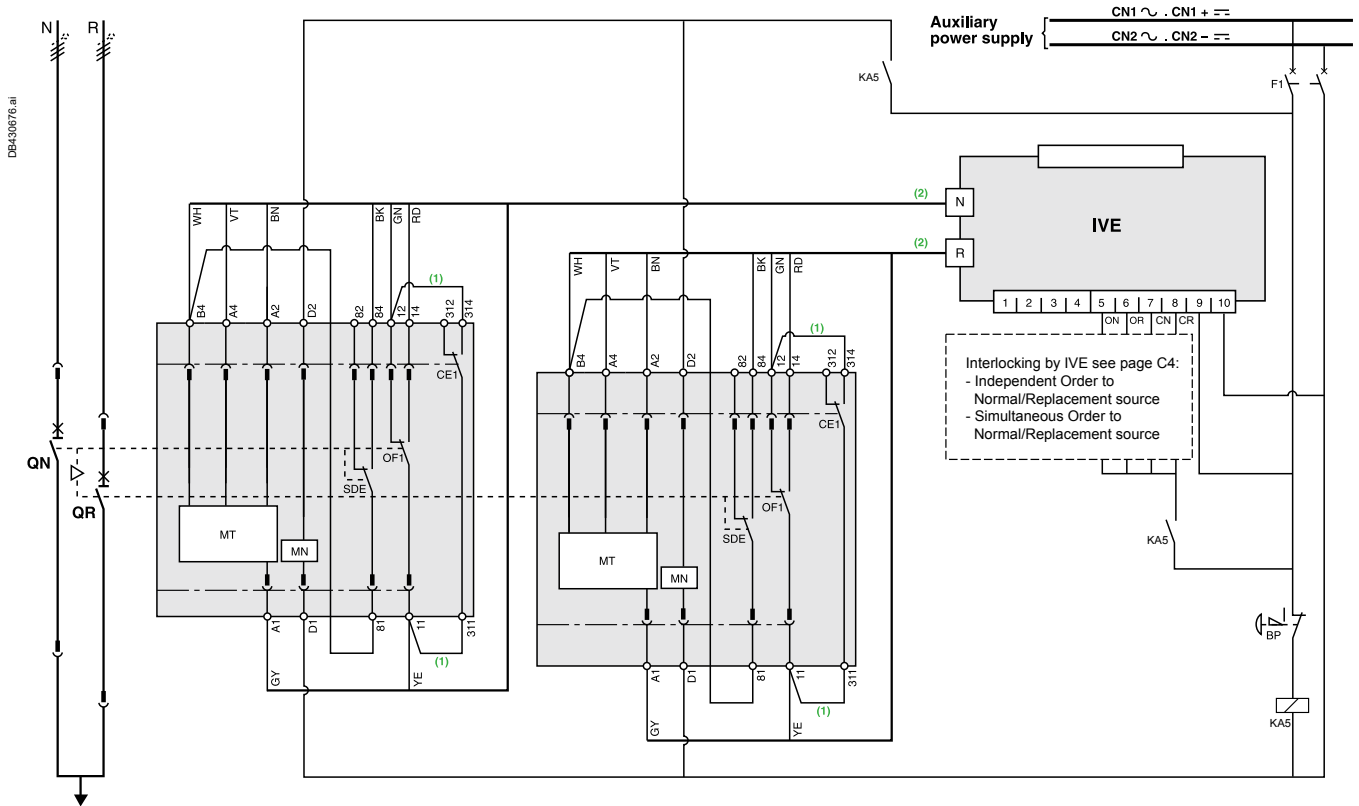

**ATTENTION**

The diagram shows the electrical wiring for circuit breakers. When wiring the SDE with **switch-disconnectors**, connect wire **BK** to terminal **82**.

- [1] Not to be wired on fixed version.
- [2] Prefabricated wiring supplied.

**Legends**

- QN "Normal" source ComPacT NS630b to 1600
- QR "Replacement" source ComPacT NS630b to 1600
- OF... breaker ON/OFF indication contact
- SDE "fault-trip" indication contact
- CE1 "connected-position" indication contact (carriage switch)
- F1 auxiliary power supply circuit breaker
- IVE electrical interlocking and terminal block unit
- MN undervoltage release
- BP emergency off button with latching
- KA5 auxiliary relay
- ON "Normal" source opening order
- OR "Replacement" source opening order
- CN "Normal" source closing order (0.25 second delay)
- CR "Replacement" source closing order (0.25 second delay)
- MT Motor Mechanism

**Wiring colour codes**

RD	GN	BK	VT	YE	GY	WH	BN
red	green	black	violet	yellow	grey	white	brown

**States permitted by mechanical interlocking system**

Normal	Replacement
0	0
1	0
0	1

**Note:** after a fault trip, the breaker must be reset manually by pressing its reset button.  
 Diagram shown with circuit breakers in connected position, open, charged, and ready to close.  
 Auxiliary power supply = supply voltage of auxiliary relays (KA...) = supply voltage of electrical auxiliaries (electrical operation, MN, MT...).

# Remote-operated source-changeover systems

## 2 MasterPacT MTZ1 or MTZ2/MTZ3 devices

**Electrical interlocking by IVE unit with lockout after a fault**

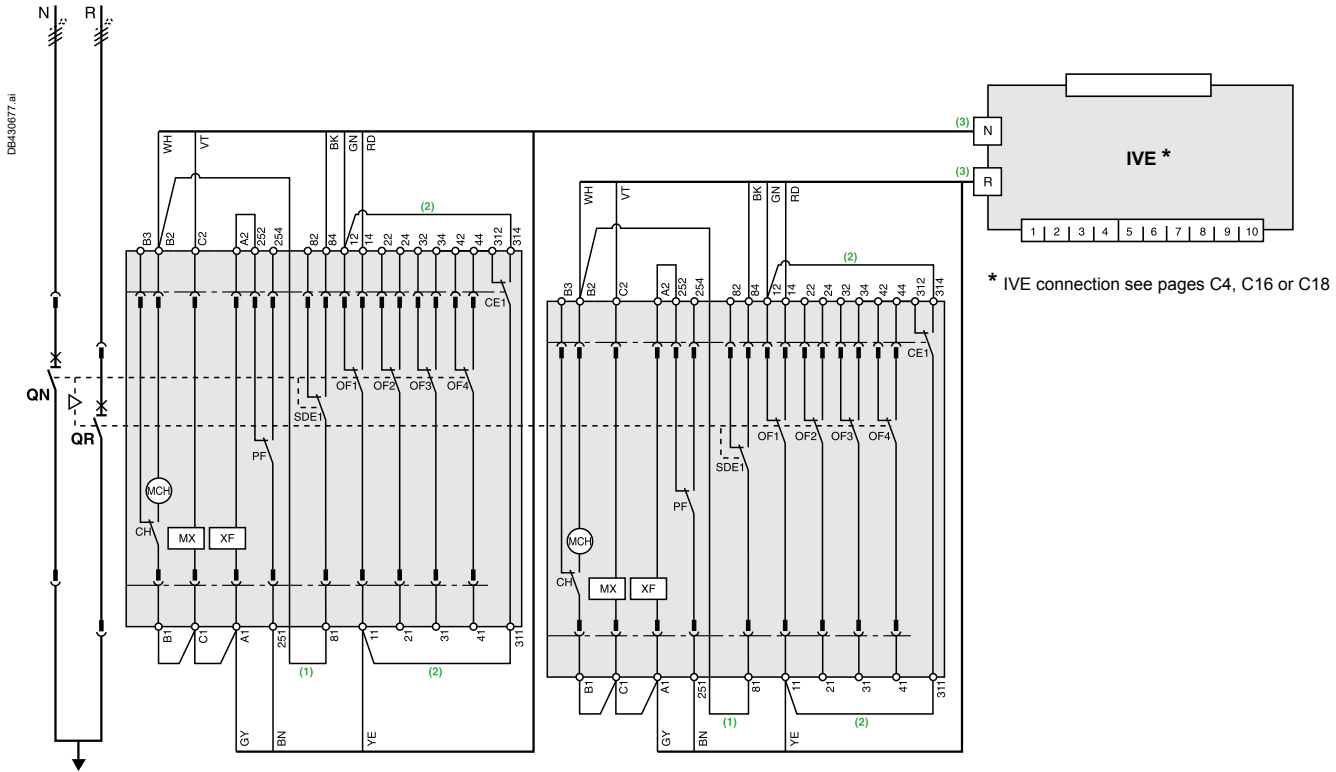

\* IVE connection see pages C4, C16 or C18

**ATTENTION**

The diagram shows the electrical wiring for circuit breakers. When wiring the SDE with **switch-disconnectors**, connect wire BK to terminal 82.

- [1] Not to be wired for the “without lockout after a fault” solution.
- [2] Not to be wired on fixed version.
- [3] Prefabricated wiring supplied.

**Legends**

- QN “Normal” source MasterPacT MTZ1 or MTZ2 or MTZ3
- QR “Replacement” source MasterPacT MTZ1 or MTZ2 or MTZ3
- MCH spring-charging motor
- MX standard opening voltage release
- XF standard closing voltage release
- OF... breaker ON/OFF indication contact
- SDE1 “fault-trip” indication contact
- PF “ready-to-close” contact
- CE1 “connected-position” indication contact (carriage switch)
- CH “springs charged” indication contact
- IVE electrical interlocking and terminal block unit
- F1 auxiliary power supply circuit breaker
- ON “Normal” source opening order
- OR “Replacement” source opening order
- CN “Normal” source closing order (0.25 second delay)
- CR “Replacement” source closing order (0.25 second delay)

**Wiring colour codes**

RD	GN	BK	VT	YE	GY	WH	BN
red	green	black	violet	yellow	grey	white	brown

**States permitted by mechanical interlocking system**

Normal	Replacement
0	0
1	0
0	1

**Note:** diagram shown with circuit breakers in connected position, open, charged, and ready to close. Auxiliary power supply = supply voltage of auxiliary relays (KA...) = supply voltage of electrical auxiliaries (electrical operation, MCH, MX, XF...).

# Remote-operated source-changeover systems

## 2 MasterPacT MTZ1 or MTZ2 or MTZ3 devices

**Electrical interlocking by IVE unit with lockout after a fault and emergency off by shunt release**

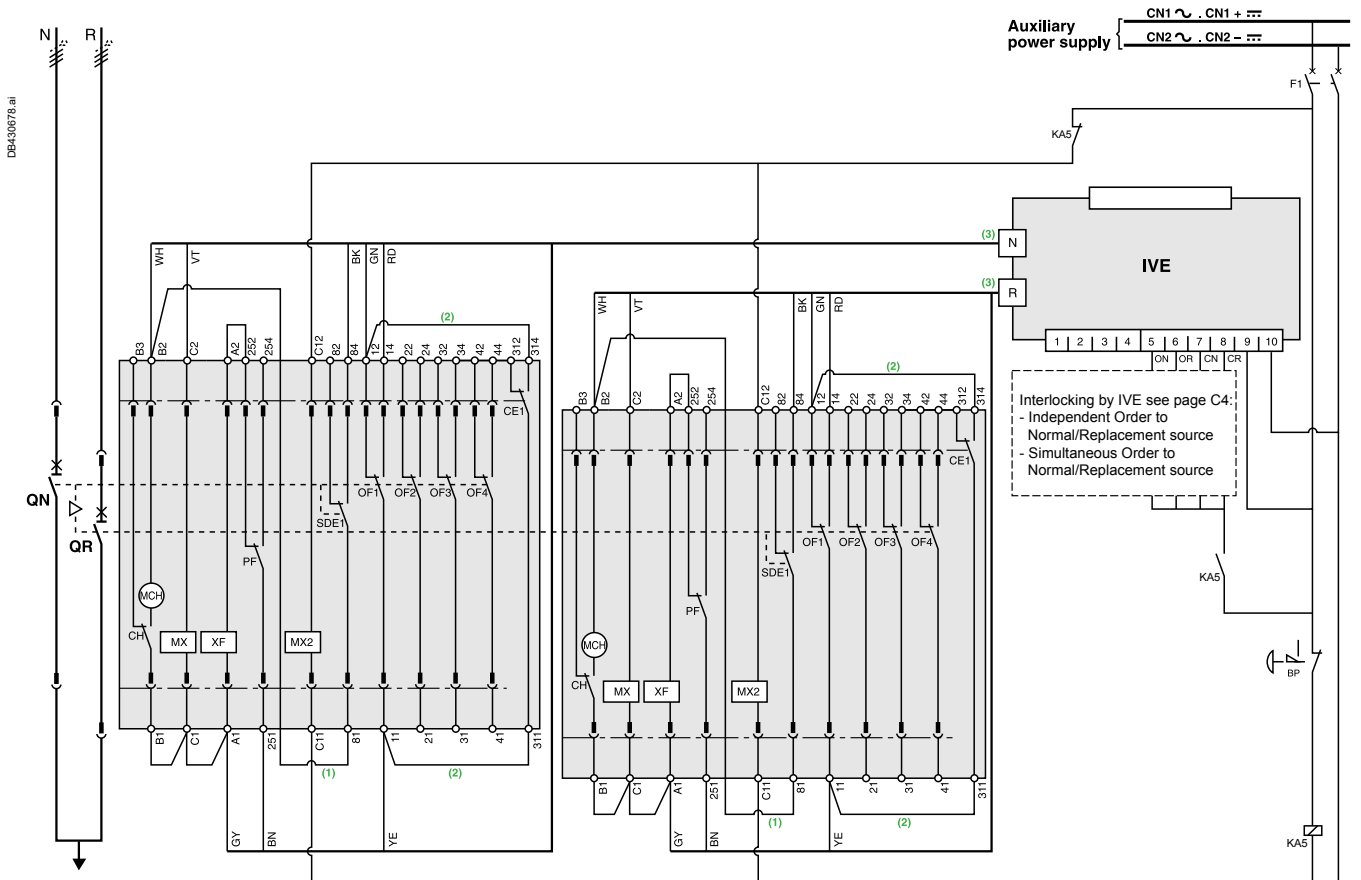

**ATTENTION**

The diagram shows the electrical wiring for circuit breakers. When wiring the SDE with **switch-disconnectors**, connect wire BK to terminal 82.

- [1] Not to be wired for the "without lockout after a fault" solution.
- [2] Not to be wired on fixed version.
- [3] Prefabricated wiring supplied.

**Legends**

- QN "Normal" source MasterPacT MTZ1 or MTZ2 or MTZ3
- QR "Replacement" source MasterPacT MTZ1 or MTZ2 or MTZ3
- MCH spring-charging motor
- MX standard opening voltage release
- XF standard closing voltage release
- OF... breaker ON/OFF indication contact
- SDE1 "fault-trip" indication contact
- PF "ready-to-close" contact
- CE1 "connected-position" indication contact (carriage switch)
- CH "springs charged" indication contact
- IVE electrical interlocking and terminal block unit
- KA5 auxiliary relay
- F1 auxiliary power supply circuit breaker
- BP emergency off button with latching
- ON "Normal" source opening order
- OR "Replacement" source opening order
- CN "Normal" source closing order (0.25 second delay)
- CR "Replacement" source closing order (0.25 second delay)

**Wiring colour codes**

<b>RD</b>	<b>GN</b>	<b>BK</b>	<b>VT</b>	<b>YE</b>	<b>GY</b>	<b>WH</b>	<b>BN</b>
red	green	black	violet	yellow	grey	white	brown

**States permitted by mechanical interlocking system**

Normal	Replacement
0	0
1	0
0	1

**Note:** diagram shown with circuit breakers in connected position, open, charged, and ready to close. Auxiliary power supply = supply voltage of auxiliary relays (KA...) = supply voltage of electrical auxiliaries (electrical operation, MCH, MX, XF...).



# Remote-operated source-changeover systems

## 2 MasterPacT MTZ1 or MTZ2 or MTZ3 devices

**Electrical interlocking by IVE unit with lockout after a fault and emergency off by undervoltage release**

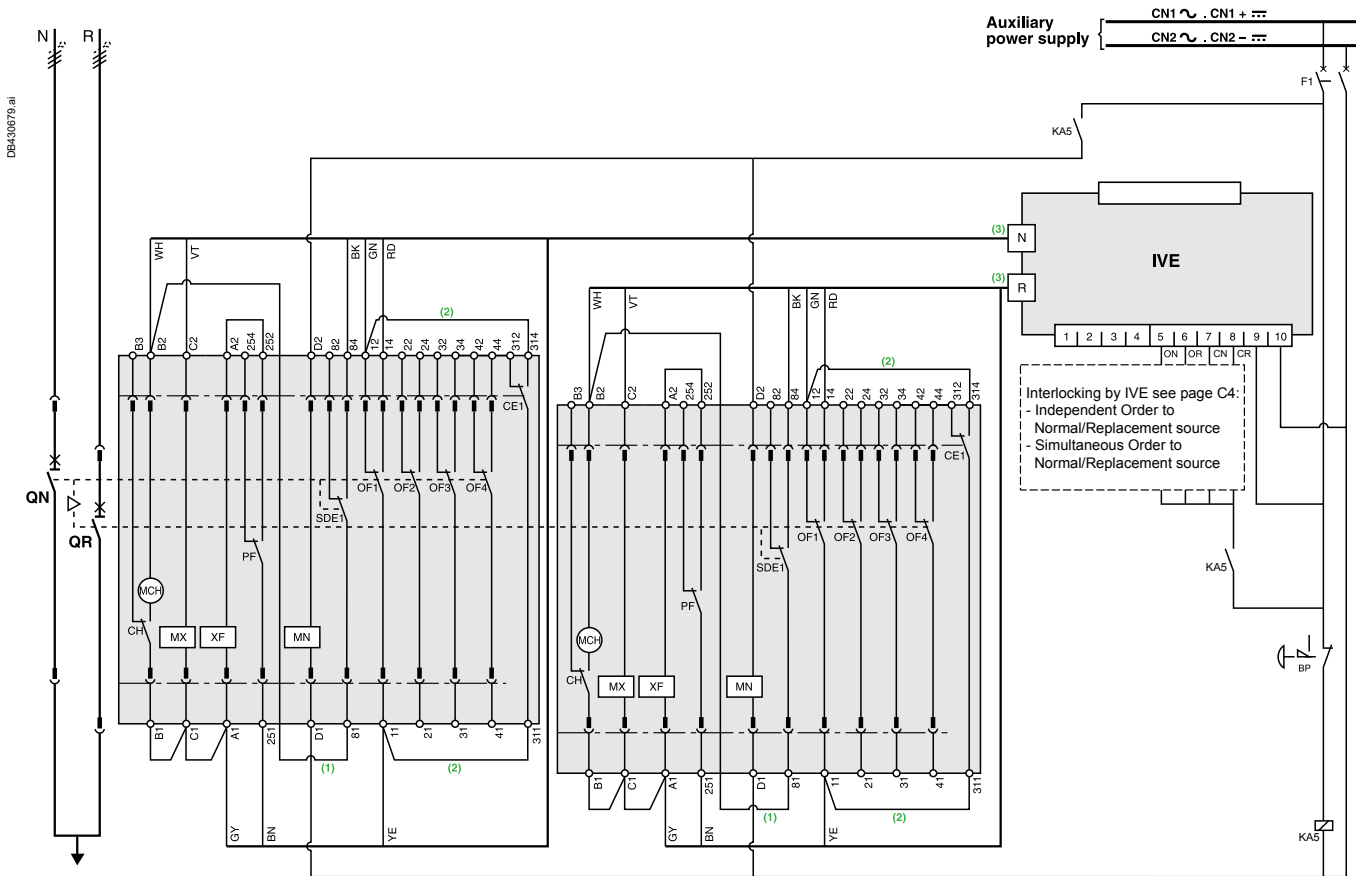

**ATTENTION**  
 The diagram shows the electrical wiring for circuit breakers. When wiring the SDE with switch-disconnectors, connect wire BK to terminal 82.

- [1] Not to be wired for the "without lockout after a fault" solution.
- [2] Not to be wired on fixed version.
- [3] Prefabricated wiring supplied.

**Legends**

- QN "Normal" source MasterPacT MTZ1 or MTZ2 or MTZ3
- QR "Replacement" source MasterPacT MTZ1 or MTZ2 or MTZ3
- MCH spring-charging motor
- MX standard opening voltage release
- XF standard closing voltage release
- MN undervoltage release
- OF... breaker ON/OFF indication contact
- SDE1 "fault-trip" indication contact
- PF "ready-to-close" contact
- CE1 "connected-position" indication contact (carriage switch)
- CH "springs charged" indication contact
- IVE electrical interlocking and terminal block unit
- KA5 auxiliary relay
- F1 auxiliary power supply circuit breaker
- BP emergency off button with latching
- ON "Normal" source opening order
- OR "Replacement" source opening order
- CN "Normal" source closing order (0.25 second delay)
- CR "Replacement" source closing order (0.25 second delay)

**Wiring colour codes**

RD	GN	BK	VT	YE	GY	WH	BN
red	green	black	violet	yellow	grey	white	brown

**States permitted by mechanical interlocking system**

Normal	Replacement
0	0
1	0
0	1

**Note:** diagram shown with circuit breakers in connected position, open, charged, and ready to close. Auxiliary power supply = supply voltage of auxiliary relays (KA...) = supply voltage of electrical auxiliaries (electrical operation, MCH, MX, MN, XF...).

# Remote-operated source-changeover systems

## 2 MasterPacT MTZ1 or MTZ2 or MTZ3 devices

**Automatic-control system for permanent replacement source with lockout after a fault (with MN)**

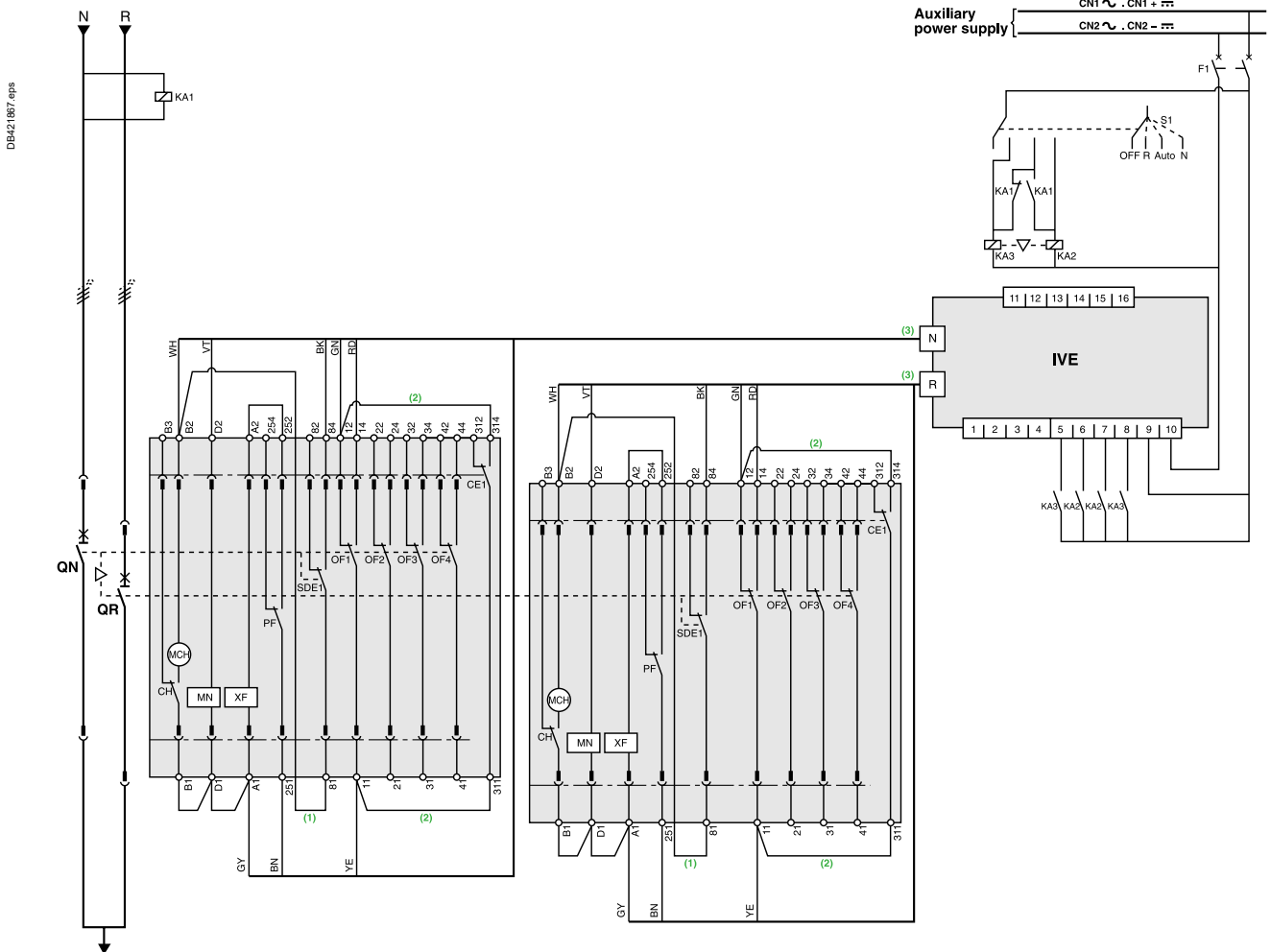

**ATTENTION**

The diagram shows the electrical wiring for circuit breakers. When wiring the SDE with **switch-disconnectors**, connect wire BK to terminal 82.

- [1] Not to be wired for the "without lockout after a fault" solution.
- [2] Not to be wired on fixed version.
- [3] Prefabricated wiring supplied.

**IMPORTANT**

The relays controlling the closing order to the "Normal" and "Replacement" circuit breakers must be mechanically and/or electrically interlocked to prevent them from giving simultaneous closing commands.

It is recommended to use **Tesys K** relays from Schneider Electric reference LC2-K06010●●. These relays are mechanically and electrically interlocked.

- Legends
- QN "Normal" source MasterPacT MTZ1 or MTZ2 or MTZ3
  - QR "Replacement" source MasterPacT MTZ1 or MTZ2 or MTZ3
  - MCH spring-charging motor
  - XF standard closing voltage release
  - MN undervoltage release
  - OF... breaker ON/OFF indication contact
  - SDE1 "fault-trip" indication contact
  - PF "ready-to-close" contact
  - CE1 "connected-position" indication contact (carriage switch)
  - CH "springs charged" indication contact
  - IVE electrical interlocking and terminal block unit
  - F1 auxiliary power supply circuit breaker
  - F2 circuit breaker (high breaking capacity)
  - S1 control switches
  - KA1 auxiliary relays
  - KA2 auxiliary relays
  - KA3 auxiliary relays

**Wiring colour codes**

RD	GN	BK	VT	YE	GY	WH	BN
red	green	black	violet	yellow	grey	white	brown

**States permitted by mechanical interlocking system**

Normal	Replacement
0	0
1	0
0	1

**Note:** diagram shown with circuit breakers in connected position, open, charged, and ready to close.  
 Auxiliary power supply = supply voltage of auxiliary relays (KA...) = supply voltage of electrical auxiliaries (electrical operation, MCH, MN, XF...).



# Remote-operated source-changeover systems

## 2 MasterPacT MTZ1 or MTZ2 or MTZ3 devices

**Automatic-control system for replacement source generator set with lockout after a fault (with MN)**

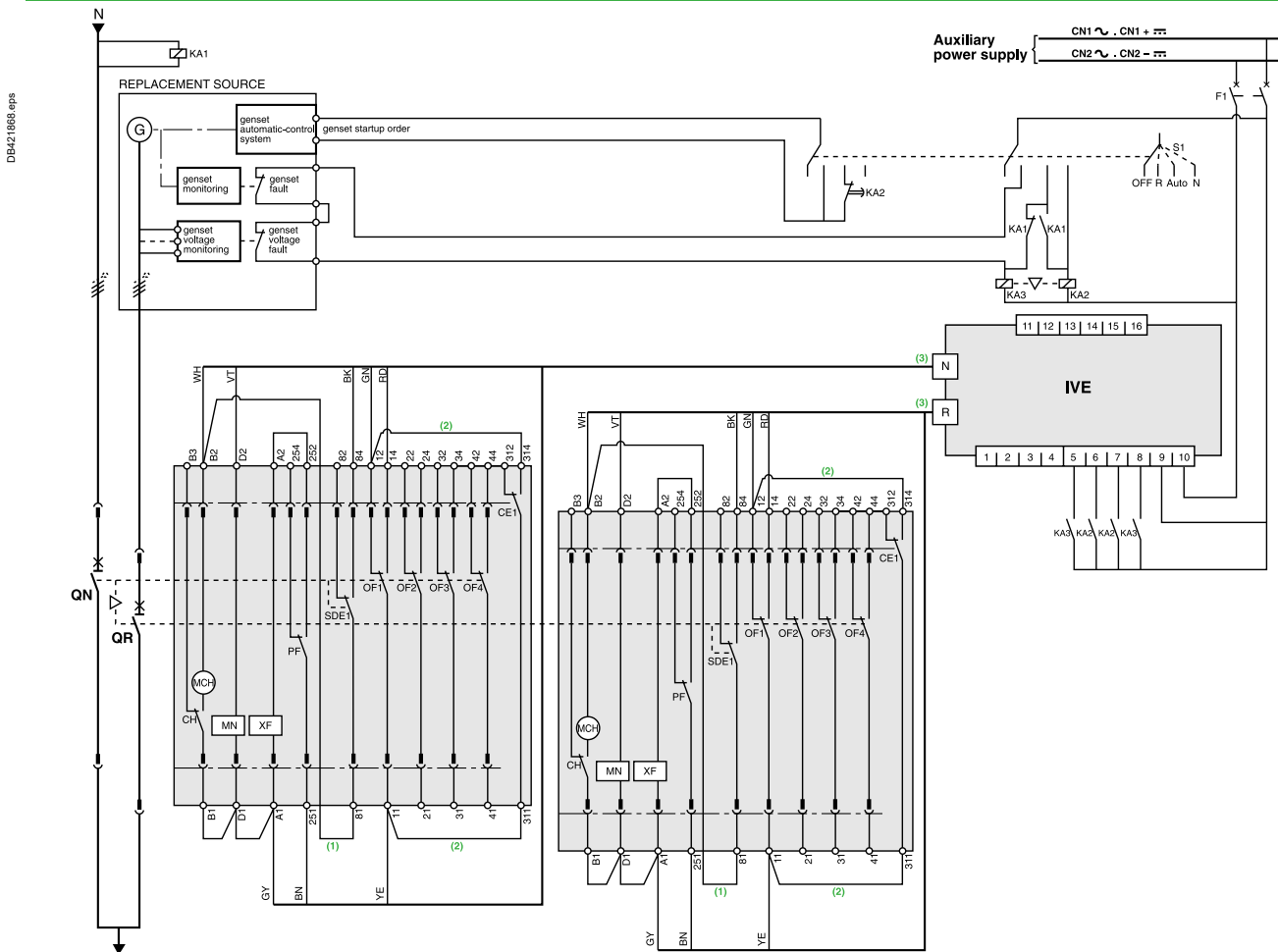

**ATTENTION**  
 The diagram shows the electrical wiring for circuit breakers. When wiring the SDE with switch-disconnectors, connect wire BK to terminal 82.

- [1] Not to be wired for the "without lockout after a fault" solution.
- [2] Not to be wired on fixed version.
- [3] Prefabricated wiring supplied.

**IMPORTANT**  
 The relays controlling the closing order to the "Normal" and "Replacement" circuit breakers must be mechanically and/or electrically interlocked to prevent them from giving simultaneous closing commands.  
 It is recommended to use **Tesys K** relays from Schneider Electric reference LC2-K06010●●. These relays are mechanically and electrically interlocked.

- Legends
- QN "Normal" source MasterPacT MTZ1 or MTZ2 or MTZ3
  - QR "Replacement" source MasterPacT MTZ1 or MTZ2 or MTZ3
  - MCH spring-charging motor
  - XF standard closing voltage release
  - MN undervoltage release
  - OF... breaker ON/OFF indication contact
  - SDE1 "fault-trip" indication contact
  - PF "ready-to-close" contact
  - CE1 "connected-position" indication contact (carriage switch)
  - CH "springs charged" indication contact
  - IVE electrical interlocking and terminal block unit
  - F1 auxiliary power supply circuit breaker
  - F2 circuit breaker (high breaking capacity)
  - S1 control switches
  - KA1 auxiliary relay
  - KA2 time delay for genset startup order to avoid starting the genset for transient UN disturbances
  - KA3 auxiliary relay

**Wiring colour codes**

RD	GN	BK	VT	YE	GY	WH	BN
red	green	black	violet	yellow	grey	white	brown

**States permitted by mechanical interlocking system**

Normal	Replacement
0	0
1	0
0	1

**Note:** diagram shown with circuit breakers in connected position, open, charged, and ready to close.  
 Auxiliary power supply = supply voltage of auxiliary relays (KA...) = supply voltage of electrical auxiliaries (electrical operation, MCH, MN, XF...).



# Source-changeover systems with UA controllers

2 ComPacT NSX100/630, NS630b/1600  
or MasterPacT MTZ1/MTZ2/MTZ3 devices

## Source-changeover system with UA controller

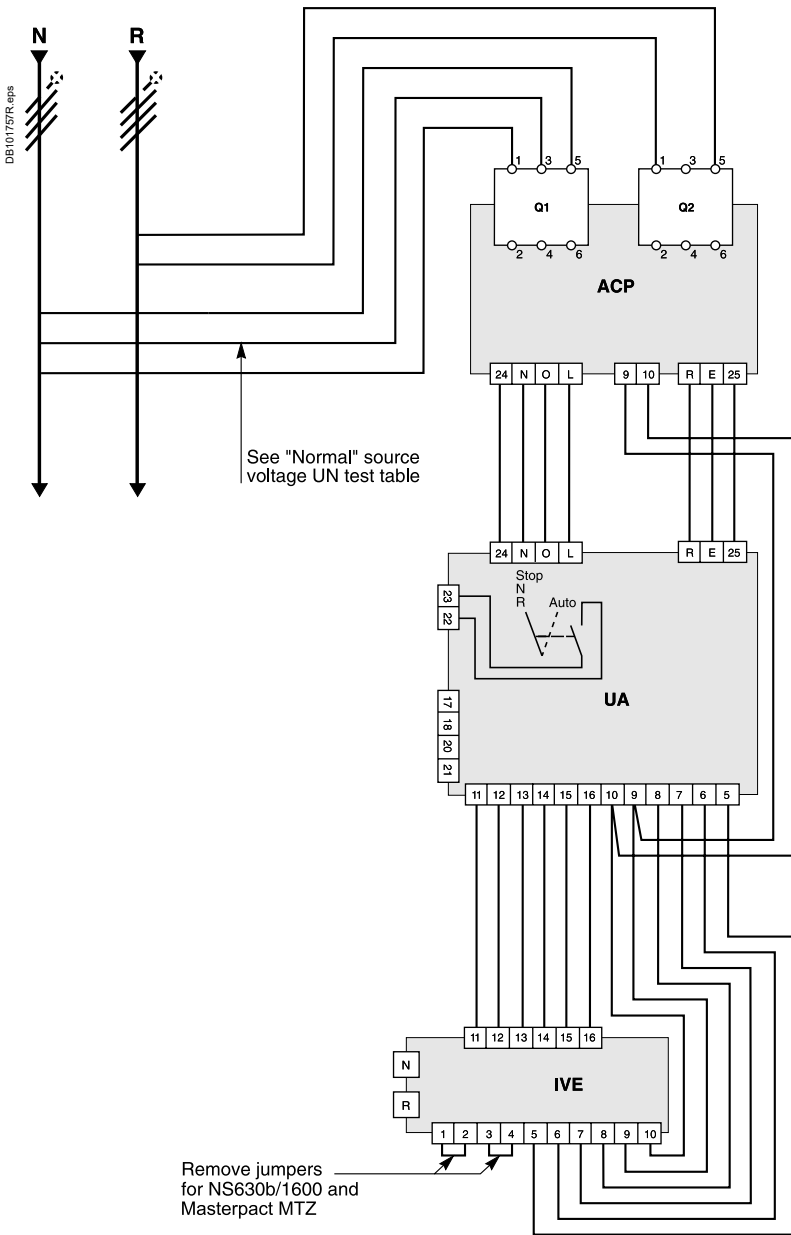

### Load shedding and genset management

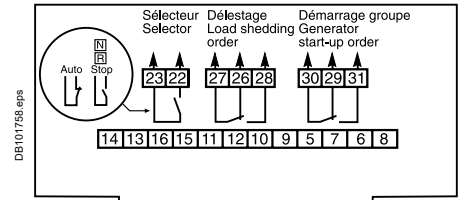

### Transfer conditions

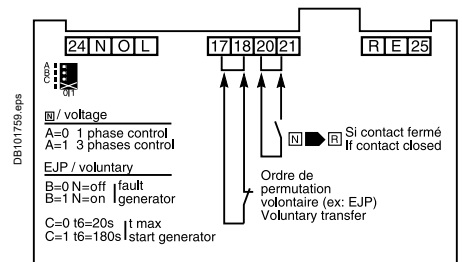

**Terminals 20 and 21:**  
additional control contact (not part of controller).

### Tests on "Normal" and "Replacement" source voltages

"Normal" source voltage UN test

Ref. UA	29472 29474	29472 29474	29473 29475
Supply voltage	N / φ 220/240VAC 50/60Hz	φ / φ 220/240VAC 50/60Hz	φ / φ 380/415VAC 50/60Hz 440V - 60Hz
Switch position			
A = 0			
A = 1			

### "Replacement" source voltage UR test

The single-phase check for UR is implemented across terminals 1 and 5 of circuit breaker Q2.

#### Legends

- Q1 circuit breaker supplying and protecting the automatic-control circuits for the "Normal" source
- Q2 circuit breaker supplying and protecting the automatic-control circuits for the "Replacement" source
- ACP control plate
- UA automatic controller
- IVE electrical interlocking and terminal block unit

**Note:** diagram shown with circuits de-energized, circuit breakers open and relays in normal position.

# Source-changeover systems with UA controllers

## Controller settings

### Source changeover system with UA controller

#### Controller settings

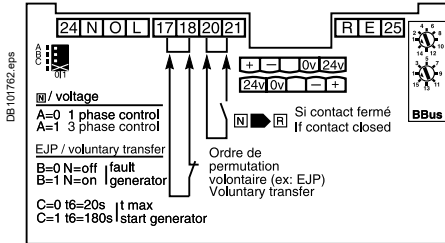

#### Tests on “Normal” source voltage

- A = 0 single-phase test,
- A = 1 three-phase test.

#### Voluntary transfert (e.g. for energy management)

- action in the event of genset failure
- B = 0 circuit breaker N opens,
- B = 1 circuit breaker N remains closed.
- maximum permissible genset startup time (T6)
- C = 0 T = 120 s,
- C = 1 T = 180 s.

After this time has elapsed, the genset is considered to have failed.

# Source-changeover systems with BA controllers

2 ComPacT NSX100/630, NS630b/1600

or MasterPacT MTZ1/MTZ2/MTZ3 devices

## Source-changeover system with BA controller

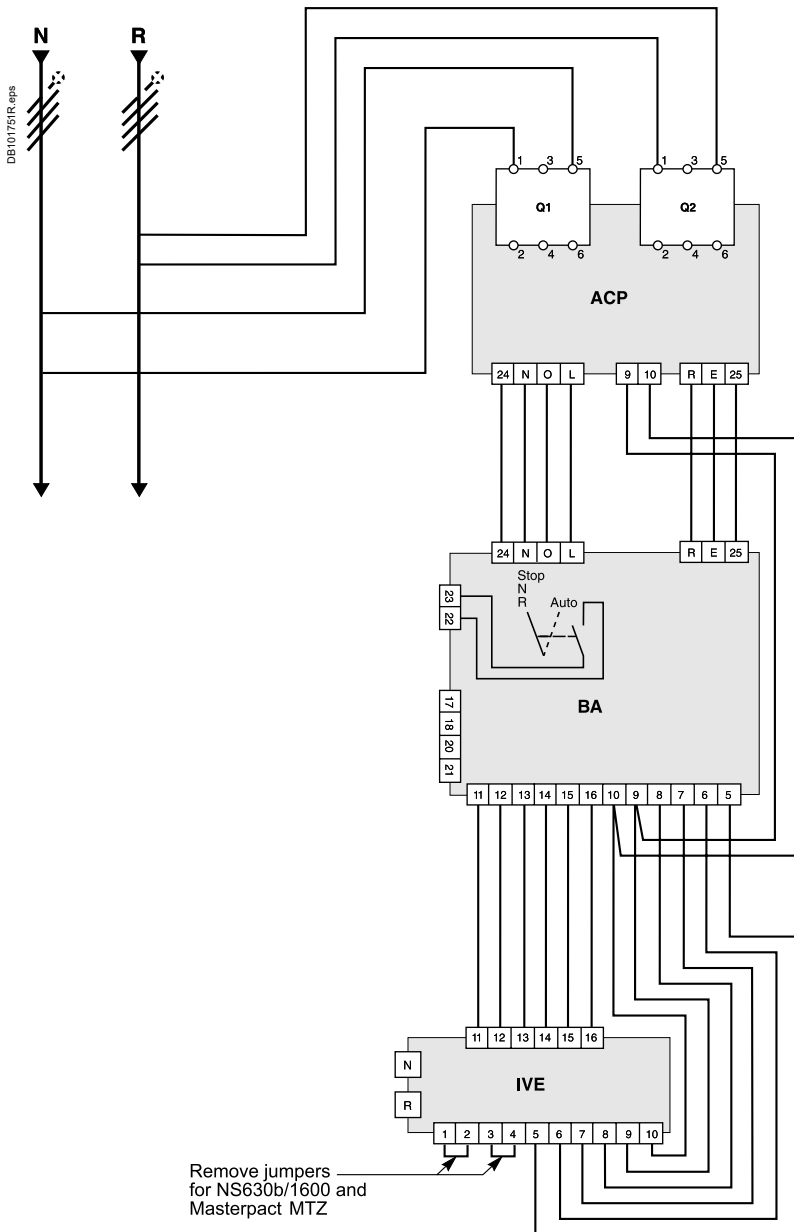

### Coupling

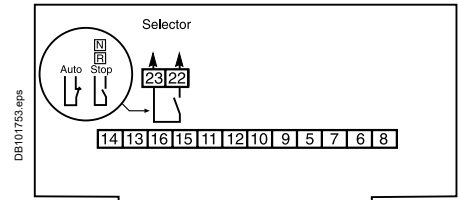

### Transfer conditions

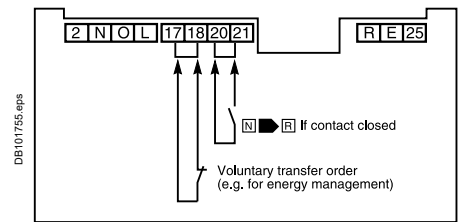

**Terminals 20 and 21:**  
additional control contact (not part of controller).

### Tests on "Normal" and "Replacement" source voltages

The single-phase check for UN and UR is implemented across terminals 1 and 5 of circuit breakers Q1 and Q2.

### Legends

- Q1 circuit breaker supplying and protecting the automatic-control circuits for the "Normal" source
- Q2 circuit breaker supplying and protecting the automatic-control circuits for the "Replacement" source
- ACP control plate
- BA automatic controller
- IVE electrical interlocking and terminal block unit

**Note:** diagram shown with circuits de-energized, circuit breakers open and relays in normal position.

# Remote-operated source-changeover systems

## 3 MasterPacT MTZ2/MTZ3 devices

**2 normal sources and 1 replacement source: electrical interlocking without lockout after a fault**

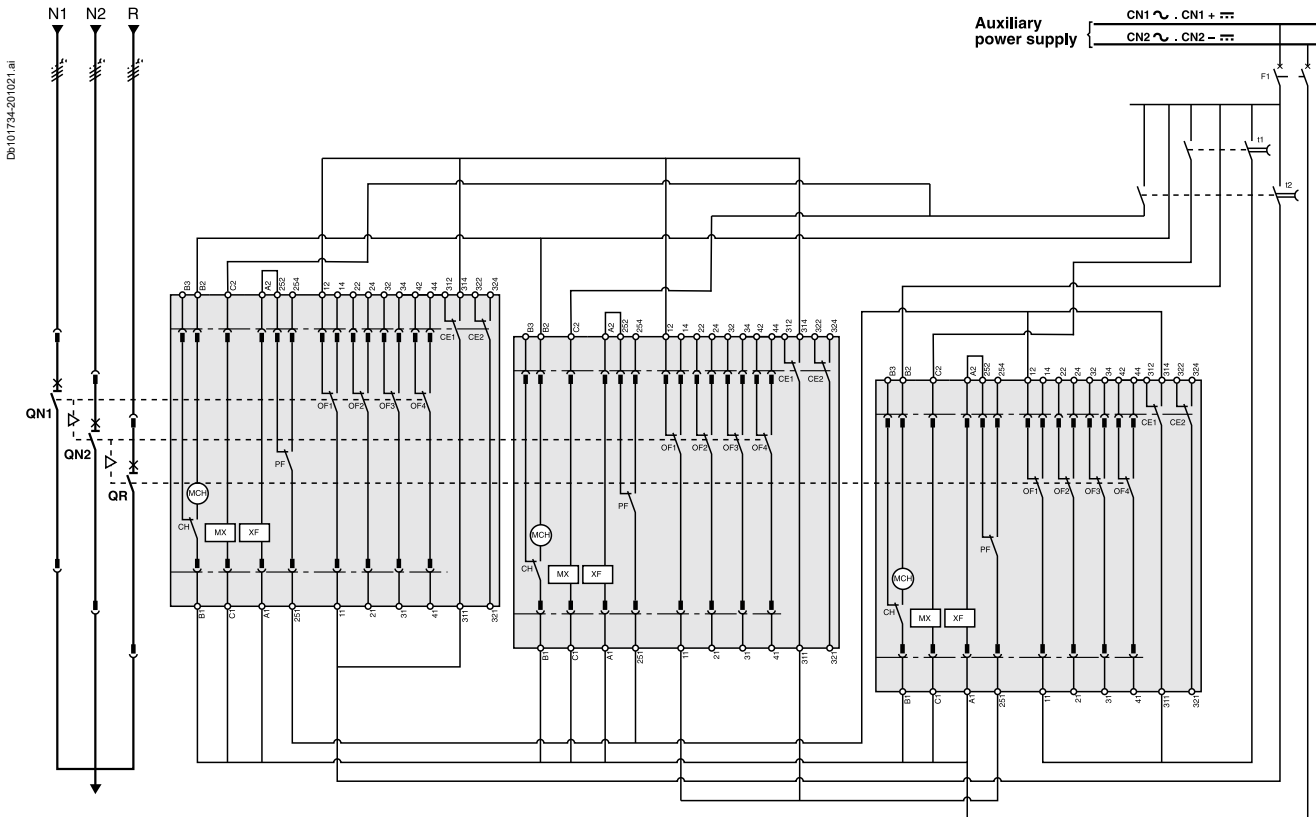

**Legends**

- QN... "Normal" source MasterPacT MTZ2 or MTZ3
- QR "Replacement" source MasterPacT MTZ2 or MTZ3
- MCH spring-charging motor
- MX standard opening voltage release
- XF standard closing voltage release
- OF... breaker ON/OFF indication contact
- PF "ready-to-close" contact
- CE "connected-position" indication contact (carriage switch)
- CH "springs charged" indication contact
- F1 auxiliary power supply circuit breaker
- t1 order for transfer from "R" to "N1 + N2"  
(QN1 and QN2 closing time delay = 0.25 sec. minimum)
- t2 order for transfer from "N1 + N2" to "R"  
(QR closing time delay = 0.25 sec. minimum)

**States permitted by mechanical interlocking system**

Normal 1	Normal 2	Replacement
0	0	0
1	1	0
0	0	1
1	0	0
0	1	0

**Note:** diagram shown with circuit breakers in connected position, open, charged, and ready to close.  
 Auxiliary power supply = supply voltage of auxiliary relays (KA...) = supply voltage of electrical auxiliaries (electrical operation, MCH, MX, XF...).

# Remote-operated source-changeover systems

## 3 MasterPacT MTZ2/MTZ3 devices

**2 normal sources and 1 replacement source: electrical interlocking with lockout after a fault**

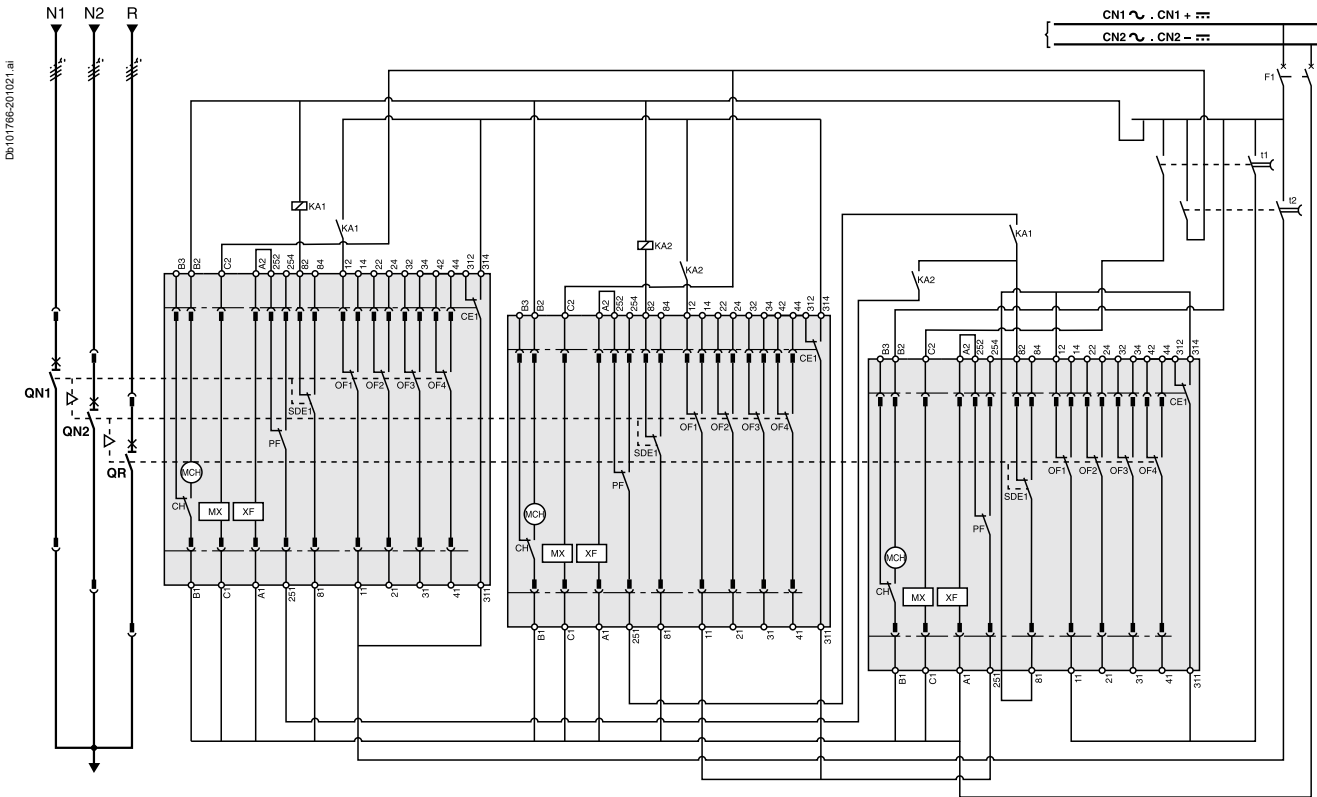

**ATTENTION**  
 The diagram shows the electrical wiring for circuit breakers. When wiring the SDE with **switch-disconnectors**, connect the SDE to terminals 81 and 84.

- Legends
- QN... "Normal" source MasterPacT MTZ2 or MTZ3
  - QR "Replacement" source MasterPacT MTZ2 or MTZ3
  - MCH spring-charging motor
  - MX standard opening voltage release
  - XF standard closing voltage release
  - OF... breaker ON/OFF indication contact
  - SDE1 "fault-trip" indication contact
  - PF "ready-to-close" contact
  - CE1 "connected-position" indication contact (carriage switch)
  - CH "springs charged" indication contact
  - F1 auxiliary power supply circuit breaker
  - S1 control switches
  - S2 source selection switches
  - KA1 auxiliary relay
  - KA2 auxiliary relays with 10 to 180 sec. time delay
  - t1 order for transfer from "R" to "N1 + N2"  
(QN1 and QN2 closing time delay = 0.25 sec. minimum)
  - t2 order for transfer from "N1 + N2" to "R"  
(QR closing time delay = 0.25 sec. minimum)

**States permitted by mechanical interlocking system**

Normal 1	Normal 2	Replacement
0	0	0
1	1	0
0	0	1
1	0	0
0	1	0

**Note:** diagram shown with circuit breakers in connected position, open, charged, and ready to close. Auxiliary power supply = supply voltage of auxiliary relays (KA...) = supply voltage of electrical auxiliaries (electrical operation, MCH, MX, XF...).



# Remote-operated source-changeover systems

## 3 MasterPacT MTZ2/MTZ3 devices

**2 normal sources and 1 replacement source: automatic-control system for generator set without lockout after a fault (with MN)**

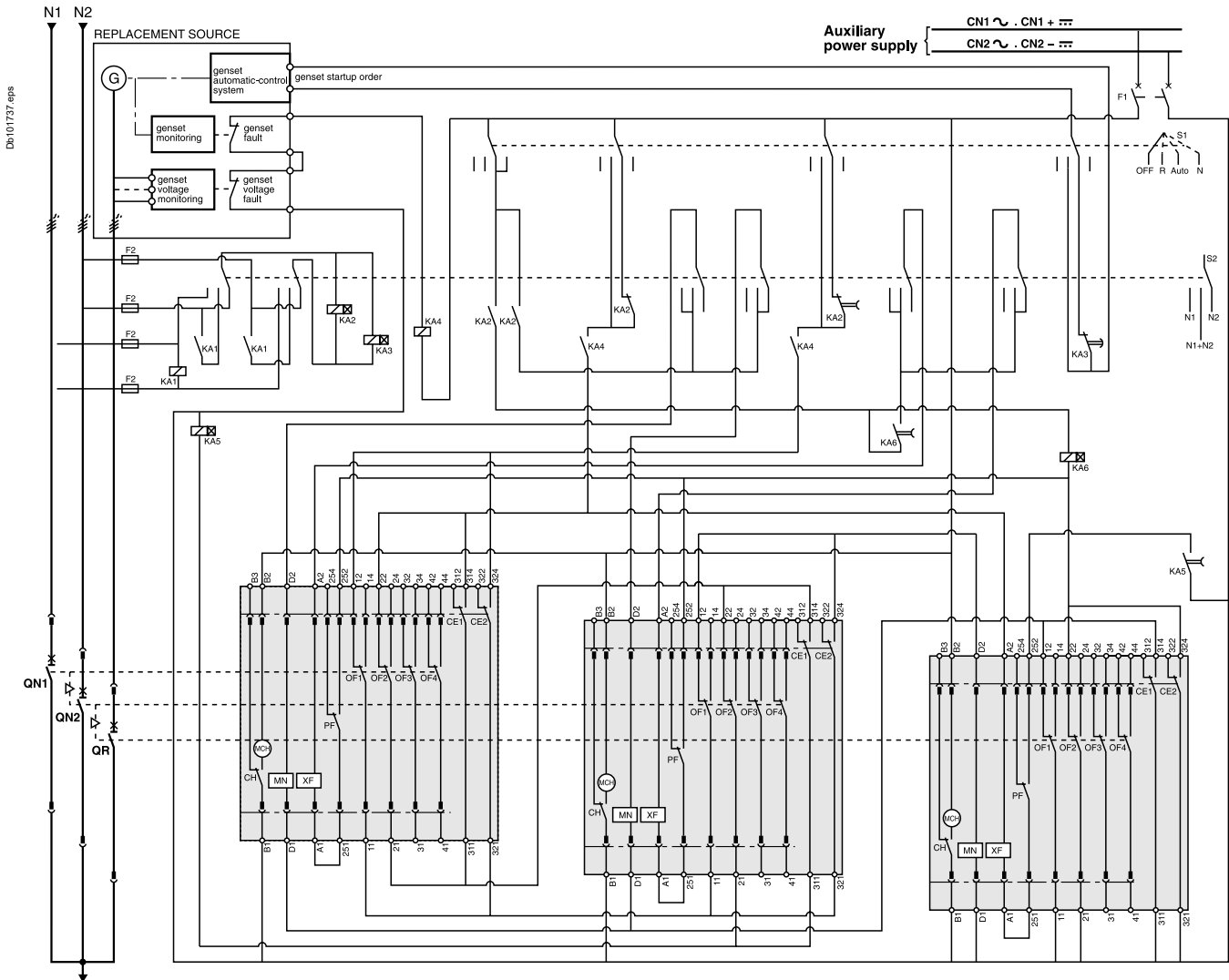

**Legends**

- QN... "Normal" source MasterPacT MTZ2 or MTZ3
- QR "Replacement" source MasterPacT MTZ2 or MTZ3
- MCH spring-charging motor
- XF standard closing voltage release
- MN undervoltage release
- OF... breaker ON/OFF indication contact
- PF "ready-to-close" contact
- CE... "connected-position" indication contact (carriage switch)
- CH "springs charged" indication contact
- F1 auxiliary power supply circuit breaker
- F2/F3 circuit breaker (high breaking capacity)
- S1 control switches
- S2 source selection switches
- KA1 auxiliary relay
- KA2 auxiliary relays with 10 to 180 sec. time delay
- KA3 auxiliary relays with 0.1 to 30 sec. time delay
- KA4 auxiliary relay
- KA5 auxiliary relays with 0.25 sec. time delay
- KA6 auxiliary relays with 0.25 sec. time delay

**States permitted by mechanical interlocking system and with associated automatism**

Normal 1	Normal 2	Replacement
0	0	0
1	1	0
0	0	1
1	0	0
0	1	0

**Note:** diagram shown with circuit breakers in connected position, open, charged, and ready to close. Auxiliary power supply = supply voltage of auxiliaries (electrical operation, MCH, MN, XF...).

# Remote-operated source-changeover systems

## 3 MasterPacT MTZ2/MTZ3 devices

2 normal sources and 1 replacement source: automatic-control system for generator set with lockout after a fault (with MN)

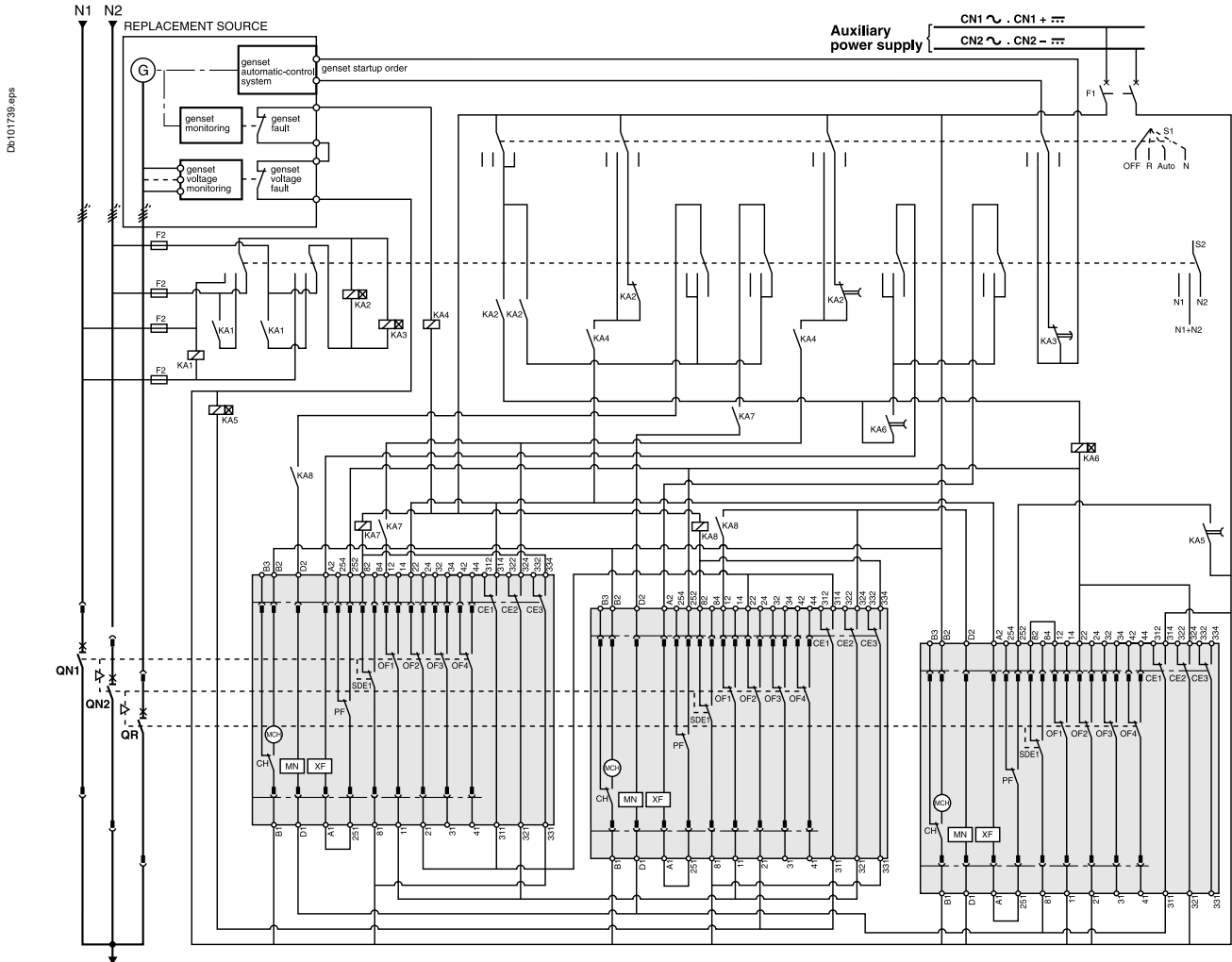

**ATTENTION**

The diagram shows the electrical wiring for circuit breakers. When wiring the SDE with **switch-disconnectors**, connect the SDE to terminals 81 and 84.

**Legends**

- QN... "Normal" source MasterPacT MTZ2 or MTZ3
- QR "Replacement" source MasterPacT MTZ2 or MTZ3
- MCH spring-charging motor
- XF standard closing voltage release
- MN undervoltage release
- OF... breaker ON/OFF indication contact
- SDE1 "fault-trip" indication contact
- PF "ready-to-close" contact
- CE... "connected-position" indication contact (carriage switch)
- CH "springs charged" indication contact
- F1 auxiliary power supply circuit breaker
- F2/F3 circuit breaker (high breaking capacity)
- S1 control switches
- S2 source selection switches
- KA1 auxiliary relay
- KA2 auxiliary relays with 10 to 180 sec. time delay
- KA3 auxiliary relays with 0.1 to 30 sec. time delay
- KA4 auxiliary relay
- KA5 auxiliary relays with 0.25 sec. time delay
- KA6 auxiliary relays with 0.25 sec. time delay
- KA7 auxiliary relay
- KA8 auxiliary relay

**States permitted by mechanical interlocking system and with associated automatism**

Normal 1	Normal 2	Replacement
0	0	0
1	1	0
0	0	1
1	0	0
0	1	0

**Note:** diagram shown with circuit breakers in connected position, open, charged, and ready to close. Auxiliary power supply = supply voltage of auxiliary relays (KA...) = supply voltage of electrical auxiliaries (electrical operation, MCH, MN, XF...).

# Remote-operated source-changeover systems

## 3 MasterPacT MTZ2/MTZ3 devices

**3 sources with only 1 device closed: electrical interlocking without lockout after a fault**

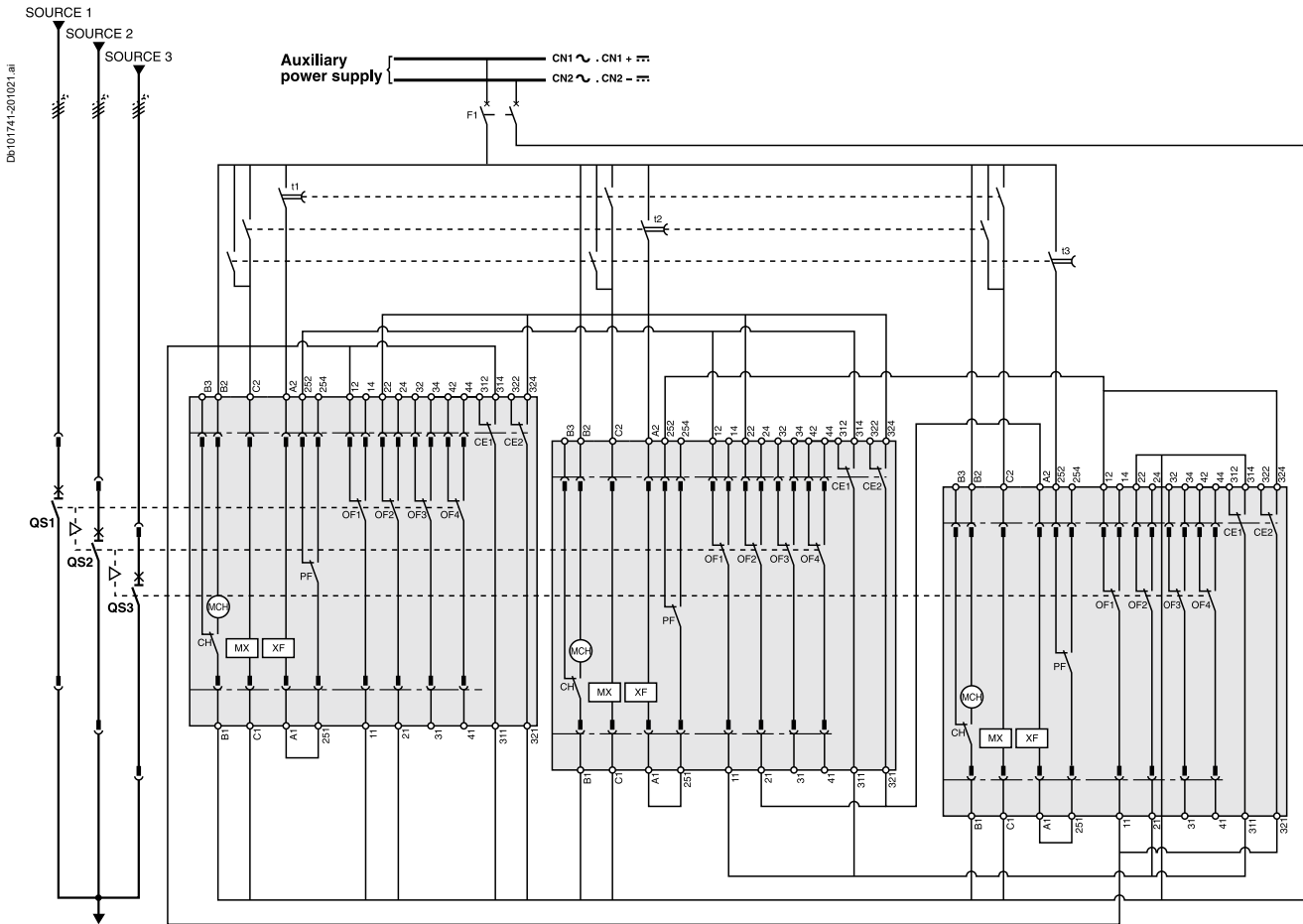

**Legends**

- QS... "Source" MasterPacT MTZ2 or MTZ3
- MCH spring-charging motor
- MX standard opening voltage release
- XF standard closing voltage release
- OF... breaker ON/OFF indication contact
- PF "ready-to-close" contact
- CE... "connected-position" indication contact (carriage switch)
- CH "springs charged" indication contact
- F1 auxiliary power supply circuit breaker
- t1 order for transfer to "Source 1"  
(QS1 closing time delay = 0.25 sec. minimum)
- t2 order for transfer to "Source 2"  
(QS2 closing time delay = 0.25 sec. minimum)
- t3 order for transfer to "Source 3"  
(QS3 closing time delay = 0.25 sec. minimum)

**States permitted by mechanical interlocking system**

Source 1	Source 2	Source 3
0	0	0
1	0	0
0	1	0
0	0	1

**Note:** diagram shown with circuit breakers in connected position, open, charged, and ready to close. Auxiliary power supply = supply voltage of auxiliary relays (KA...) = supply voltage of electrical auxiliaries (electrical operation, MCH, MX, XF...).



# Remote-operated source-changeover systems

## 3 MasterPacT MTZ2/MTZ3 devices

**3 sources with only 1 device closed: electrical interlocking with lockout after a fault**

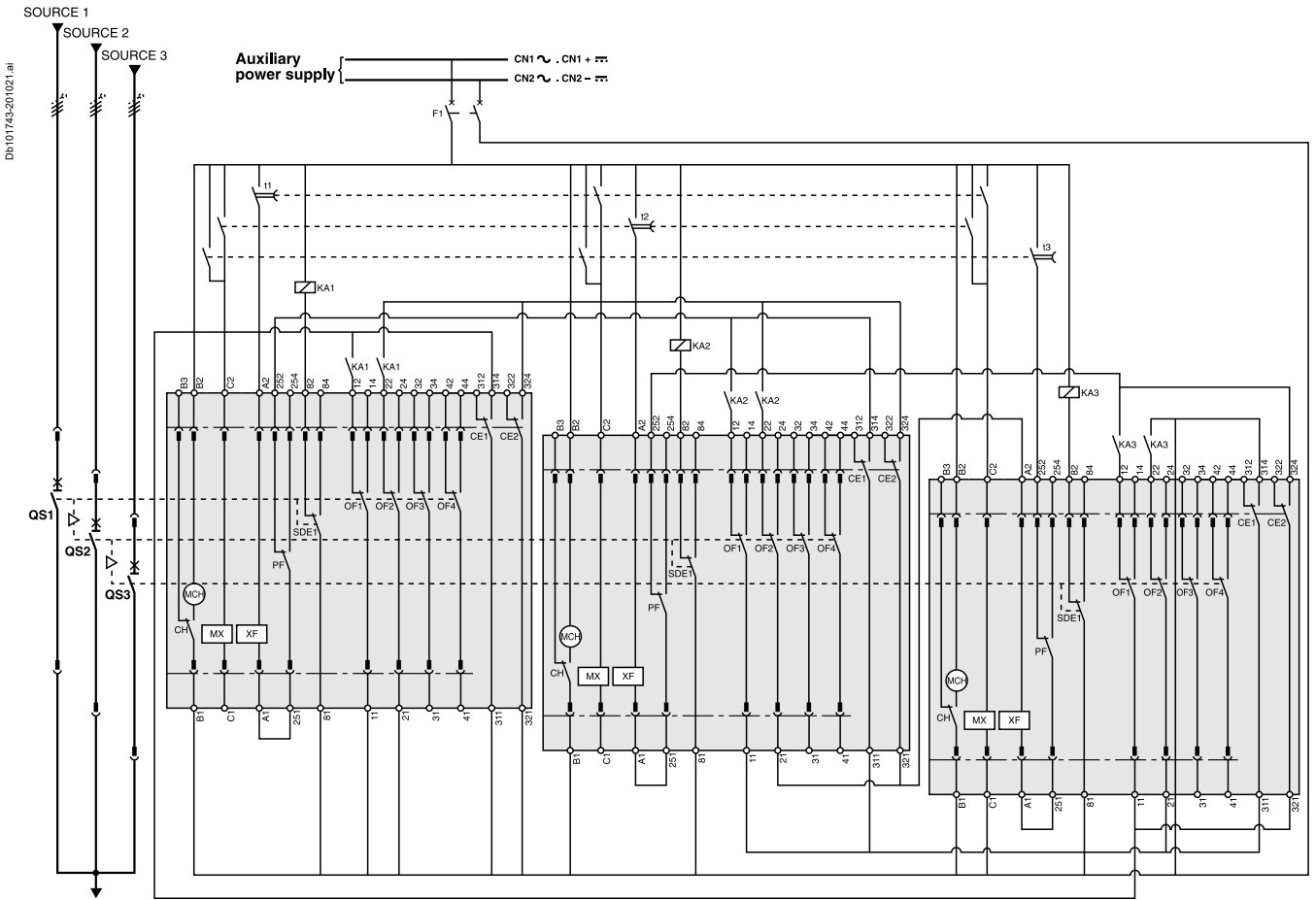

**ATTENTION**  
 The diagram shows the electrical wiring for circuit breakers. When wiring the SDE with **switch-disconnectors**, connect the SDE to terminals 81 and 84.

**Legends**

- QS... "Source" MasterPacT MTZ2 or MTZ3
- MCH spring-charging motor
- MX standard opening voltage release
- XF standard closing voltage release
- OF... breaker ON/OFF indication contact
- SDE1 "fault-trip" indication contact
- PF "ready-to-close" contact
- CE... "connected-position" indication contact (carriage switch)
- CH "springs charged" indication contact
- F1 auxiliary power supply circuit breaker
- t1 order for transfer to "Source 1"  
(QS1 closing time delay = 0.25 sec. minimum)
- t2 order for transfer to "Source 2"  
(QS2 closing time delay = 0.25 sec. minimum)
- t3 order for transfer to "Source 3"  
(QS3 closing time delay = 0.25 sec. minimum)
- KA1 auxiliary relays
- KA2 auxiliary relays
- KA3 auxiliary relays

**States permitted by mechanical interlocking system**

Source 1	Source 2	Source 3
0	0	0
1	0	0
0	1	0
0	0	1

**Note:** diagram shown with circuit breakers in connected position, open, charged, and ready to close. Auxiliary power supply = supply voltage of auxiliary relays (KA...) = supply voltage of electrical auxiliaries (electrical operation, MCH, MX, XF...).



# Remote-operated source-changeover systems

## 3 MasterPacT MTZ2/MTZ3 devices

**2 sources and 1 coupling: electrical interlocking without lockout after a fault**

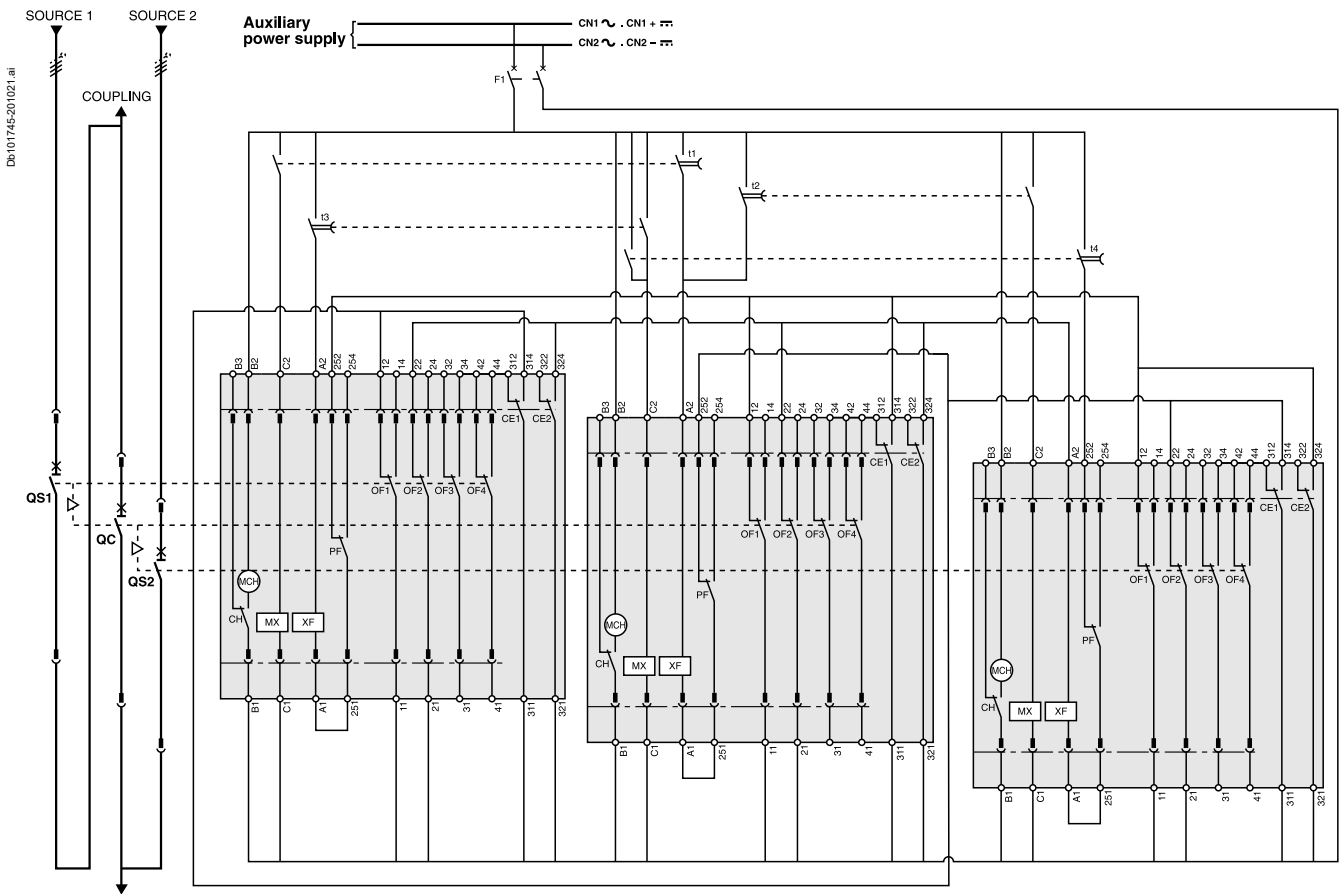

**Legends**

- QS... "Source" MasterPacT MTZ2 or MTZ3
- QC "Coupling" MasterPacT MTZ2 or MTZ3
- MCH spring-charging motor
- MX standard opening voltage release
- XF standard closing voltage release
- OF... breaker ON/OFF indication contact
- PF "ready-to-close" contact
- CE... "connected-position" indication contact (carriage switch)
- CH "springs charged" indication contact
- F1 auxiliary power supply circuit breaker
- t1 coupling order for "Source 1 failure"  
(QC closing time delay = 0.25 sec. minimum)
- t2 coupling order for "Source 2 failure"  
(QC closing time delay = 0.25 sec. minimum)
- t3 coupling order for "Source 1 restored"  
(QS1 closing time delay = 0.25 sec. minimum)
- t4 coupling order for "Source 2 restored"  
(QS2 closing time delay = 0.25 sec. minimum)

**States permitted by mechanical interlocking system**

Source 1	Source 2	Coupling
0	0	0
1	1	0
1	0	1
0	1	1
1	0	0
0	1	0
0	0	1

**Note:** diagram shown with circuit breakers in connected position, open, charged, and ready to close.  
 Auxiliary power supply = supply voltage of auxiliary relays (KA...) = supply voltage of electrical auxiliaries (electrical operation, MCH, MX, XF...).

# Remote-operated source-changeover systems

## 3 MasterPacT MTZ2/MTZ3 devices

**2 sources and 1 coupling: electrical interlocking with lockout after a fault**

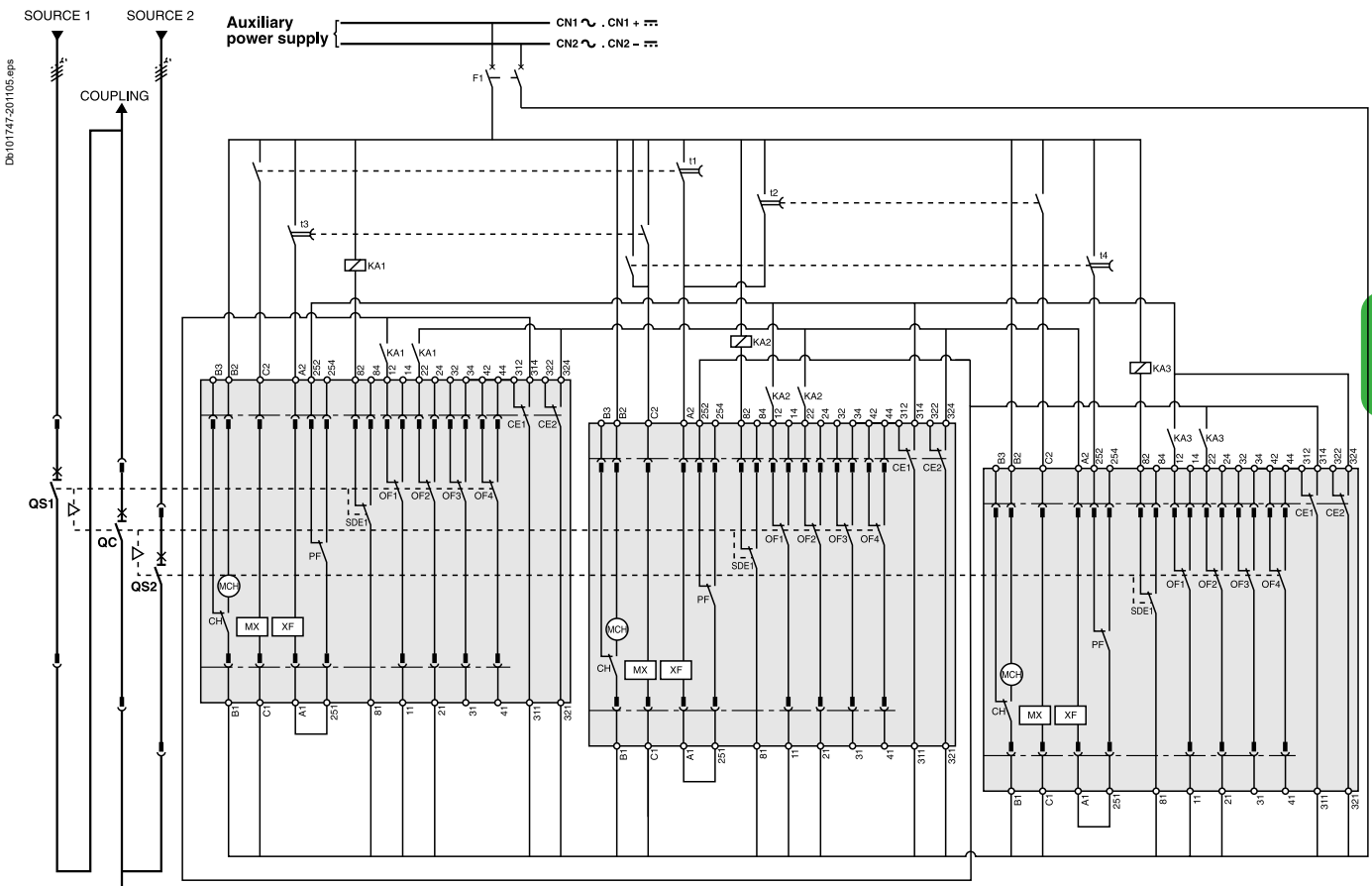

**ATTENTION**  
 The diagram shows the electrical wiring for circuit breakers. When wiring the SDE with **switch-disconnectors**, connect the SDE to terminals 81 and 84.

**Legends**

- QS... "Source" MasterPacT MTZ2 or MTZ3
- QC "Coupling" MasterPacT MTZ2 or MTZ3
- MCH spring-charging motor
- MX standard opening voltage release
- XF standard closing voltage release
- OF... breaker ON/OFF indication contact
- SDE1 "fault-trip" indication contact
- PF "ready-to-close" contact
- CE... "connected-position" indication contact (carriage switch)
- CH "springs charged" indication contact
- F1 auxiliary power supply circuit breaker
- t1 coupling order for "Source 1 failure"  
(QC closing time delay = 0.25 sec. minimum)
- t2 coupling order for "Source 2 failure"  
(QC closing time delay = 0.25 sec. minimum)
- t3 coupling order for "Source 1 restored"  
(QS1 closing time delay = 0.25 sec. minimum)
- t4 coupling order for "Source 2 restored"  
(QS2 closing time delay = 0.25 sec. minimum)
- KA1 auxiliary relays
- KA2 auxiliary relays
- KA3 auxiliary relays

**States permitted by mechanical interlocking system**

Source 1	Source 2	Coupling
0	0	0
1	1	0
1	0	1
0	1	1
1	0	0
0	1	0
0	0	1

**Note:** diagram shown with circuit breakers in connected position, open, charged, and ready to close. Auxiliary power supply = supply voltage of auxiliary relays (KA...). = supply voltage of electrical auxiliaries (electrical operation, MCH, MX, XF...).



# Remote-operated source-changeover systems

## 3 MasterPacT MTZ2/MTZ3 devices

**2 sources and 1 coupling: automatic-control system with lockout after a fault**

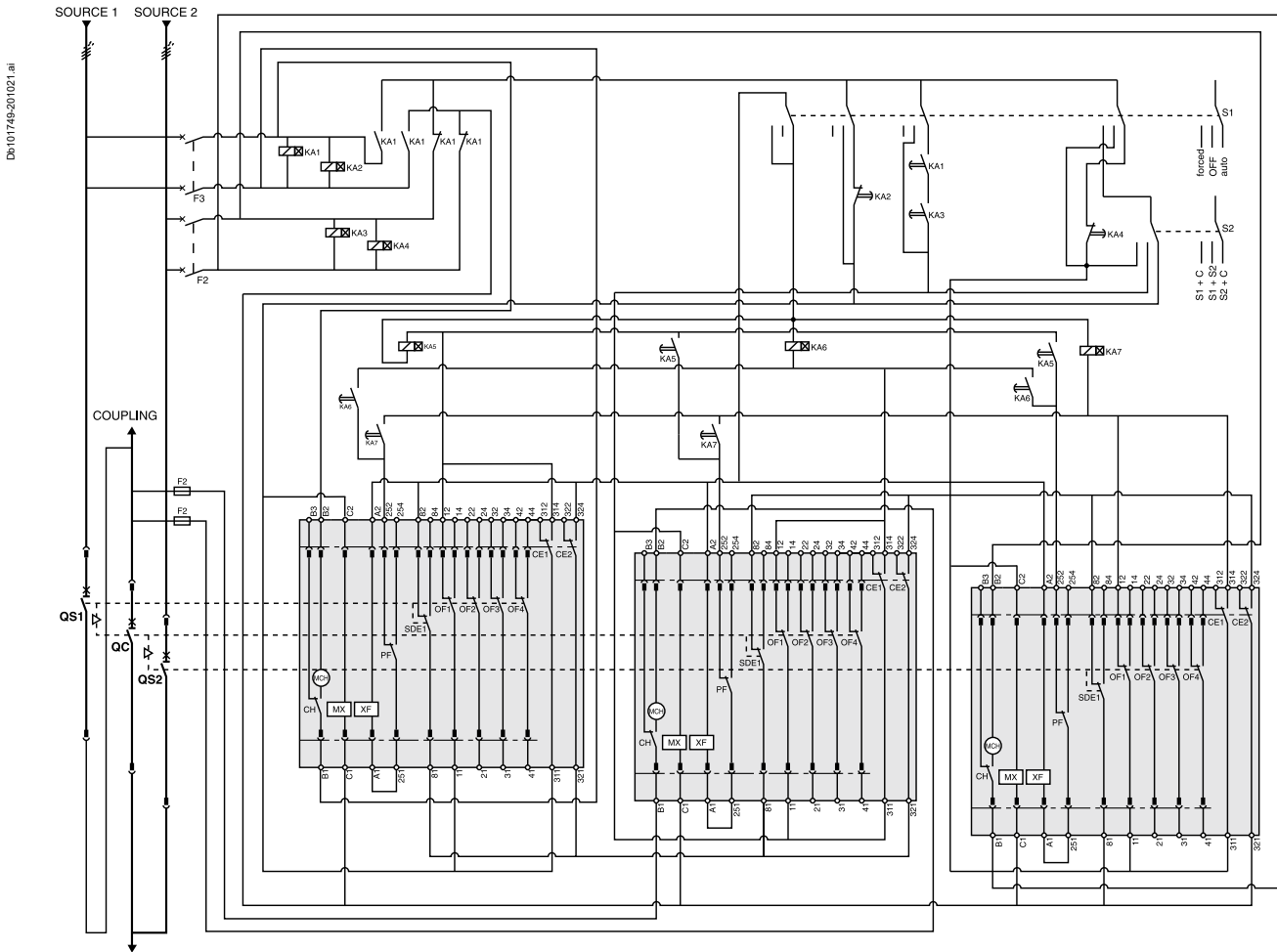

**ATTENTION**  
 The diagram shows the electrical wiring for circuit breakers. When wiring the SDE with switch-disconnectors, connect the SDE to terminals 81 and 84.

**Legends**

- QS... "Source" MasterPacT MTZ2 or MTZ3
- QC "Coupling" MasterPacT MTZ2 or MTZ3
- MCH spring-charging motor
- MX standard opening voltage release
- XF standard closing voltage release
- OF... breaker ON/OFF indication contact
- SDE1 "fault trip" indication contact
- PF "ready-to-close" contact
- CE... "connected-position" indication contact (carriage switch)
- CH "springs charged" indication contact
- F1 auxiliary power supply circuit breaker
- F2/F3 circuit breaker (high breaking capacity)
- S1 control switches
- S2 source selection switches
- KA1 auxiliary relays with 10 to 180 sec. time delay
- KA2 auxiliary relays with 0.1 to 30 sec. time delay
- KA3 auxiliary relays with 10 to 180 sec. time delay
- KA4 auxiliary relays with 0.1 to 30 sec. time delay
- KA5 auxiliary relays with 0.25 sec. time delay
- KA6 auxiliary relays with 0.25 sec. time delay
- KA7 auxiliary relays with 0.25 sec. time delay

**States permitted by mechanical interlocking system and with associated automatism**

Source 1	Source 2	Coupling
0	0	0
1	1	0
1	0	1
0	1	1
1	0	0
0	1	0
0	0	1

**Note:** diagram shown with circuit breakers in connected position, open, charged, and ready to close. Auxiliary power supply = supply voltage of auxiliary relays (KA...) = supply voltage of electrical auxiliaries (electrical operation, MCH, MX, XF...).

# References of source-changeover systems for 2 devices

## ComPacT INS40 to INS2500, INV100 to INV2500

### Manual source-changeover systems

#### Interlocking for rotary handle

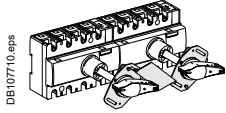
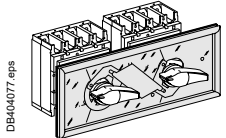
	Mechanical device for INS40 to INS160 equipped with an extended rotary handle		<b>3/4P</b> <b>28953</b>
	Mechanical device for INS250-100 to INS250/INV100 to INV250 equipped with a direct or extended rotary handle		<b>31073</b>
	Mechanical device for INS/INV320 to INS/INV630 equipped with a direct or extended rotary handle		<b>31074</b>

#### Interlocking

	Locking device for Ronis/Profalux keylocks on INS250-100 to INS250/INV100 to INV250	2x	<b>31087</b>
	Locking device for Ronis/Profalux keylocks on INS/INV320 to INS/INV630	2x	<b>31088</b>
	Locking device for Ronis/Profalux keylocks on INS/INV630b to INS/INV2500	2x	<b>31291</b>
	+ Ronis 1351B.500 keylock (2 keylocks / 1 key)		<b>41950</b>
	or + Profalux KS5 B24 D4Z keylock (2 keylocks / 1 key)		<b>42878</b>

### Connection accessories

#### Downstream coupling accessories

##### Short terminal shields (1 pair) + "Normal" source/"Replacement" source

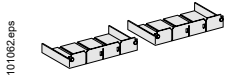
	INS250/INS250		<b>3/4P</b> <b>LV429359</b>
	INS320 to INS630/INS320 to INS630		<b>LV432620</b>

##### Long terminal shields (1 piece)

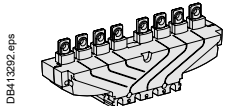
	INS250	Long terminal shield	<b>LV429518</b>
	INS320	Long terminal shield, 45 mm (1 piece)	<b>LV432594</b>
	to INS630	Long terminal shield for spreaders, 52.5 mm (1 piece)	<b>LV432596</b>

#### Terminal extensions

	Spreaders	52.5 mm	4P	<b>LV432491</b>
---	-----------	---------	----	-----------------



# References of source-changeover systems for 2 devices

## ComPacT NSX100 to NSX630

### Manual source changeover

#### Mechanical interlocking

DB404094.eps;DB404093.eps

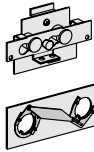

For toggle controlled circuit breakers	NSX100...250	LV429354T	
	NSX400...630	LV432614T	
For rotary handled circuit breakers	With direct rotary handle	NSX100...250	LV429369T
		NSX400...630	LV432621T
	With extended rotary handle	NSX100...250	LV429369ET
		NSX400...630	LV432621ET

#### Key lock interlocking

DB404095.eps

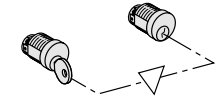

Keylock kit (keylock not included)		LV429344
1 set of 2 keylocks	Ronis 1351B.500	41950
(1 key only, keylock not included)	Profalux KS5 B24 D4Z	42878

### Remote controlled source changeover

#### Plate + IVE unit

DB404096.eps

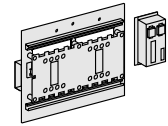

Source "Normal"/source "Replacement" (identical voltages)	24 to 250 V DC	48 to 415 V AC 50/60 Hz 440 V 60 Hz
<b>NSX100...250/NSX100...250</b>		
Plate + IVE unit <sup>[1]</sup>		
Plate	29351	29350
IVE unit	29349	29349
IVE unit	29356	29352
Auxiliary switches 2 OF + 2 SDE	4 x 29450	4 x 29450
Safety trip interlock (for fixed version only)	2 x LV429270	2 x LV429270
Spare wiring system (device/IVE unit)	29365	29365
Back sockets option add: Only long RC	[2]	[2]
Plug in base option add: Plug in kit	[2]	[2]
<b>NSX400...630/NSX100...630</b>		
Plate + IVE unit <sup>[1]</sup>		
Plate	32611	32610
IVE unit	32609	32609
IVE unit	29356	29352
Auxiliary switches 2 OF + 2 SDE	4 x 29450	4 x 29450
Safety trip interlock (for fixed version only)	2 x LV432520	2 x LV432520
Spare wiring system (device/IVE unit)	29365	29365
Back sockets option add: Only long RC	[2]	[2]
Plug in base option add: Plug in kit	[2]	[2]
Adaptator kit for NSX100...250	1 x 32618	1 x 32618

#### Control unit option

DB404097.eps

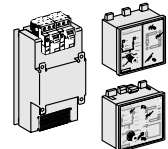

	110/127 V AC 50/60 Hz	220/240 V AC 50/60 Hz	380/415 V AC 50/60 Hz 440 V 60 Hz
ACP + controller BA <sup>[1]</sup>		29470	29471
Plate ACP		29363	29364
Controller BA		29376	29377
ACP + controller UA <sup>[1]</sup>	29448	29472	29473
Plate ACP	29447	29363	29364
Controller UA	29446	29378	29380

#### Wiring cable between UA/BA and ACP/IVE

Wiring cable (1.5 meter)	29368	29368
--------------------------	-------	-------

### Connection accessories

#### Downstream coupling accessories

DB101062.eps

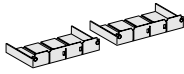

<b>Short terminal shields (1 pair) + "Normal" source/"Replacement" source</b>		
	3P	4P
NSX100...250/NSX100...250 / 250 A	LV429358	LV429359
NSX400...630/NSX400...630 / 630 A	LV432619	LV432620

DB413273.eps

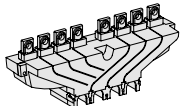

<b>Long terminal shields (1 piece)</b>		
		3/4P
NSX100...250	Long terminal shield	LV429518
NSX400...630	Long terminal shield, 45 mm (1 piece)	LV432594
	Long terminal shield for spreaders, 52.5 mm (1 piece)	LV432596

#### Terminal extensions

DB118652.eps



Spreaders	52.5 mm	4P	LV432491
-----------	---------	----	----------

[1] The supply voltages UA/BA controller, ACP plate, IVE unit and the remote control must be identical whatever the source changeover type.

[2] See products pages.

# References of source-changeover systems for 2 devices

## ComPacT NS630b to NS1600

### Circuit breakers and switch-disconnectors

#### Mechanical interlocking for source-changeover systems

##### Interlocking

For 2 devices with extended rotary handles	<b>33890</b>
--	--------------

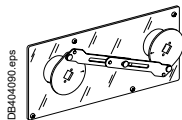

DB404090.eps

##### Interlocking using connecting rods

Complete assembly with 2 adaptation fixtures + rods	<b>33910</b>
2 ComPacT fixed devices	<b>33913</b>
2 ComPacT withdrawable devices	<b>2x 33897</b>
Push button cover (mandatory)	

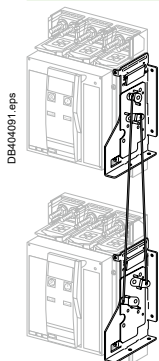

DB404091.eps

##### Interlocking using cables

Complete assembly with 2 adaptation fixtures + cables	
2 ComPacT fixed devices	<b>33911</b>
2 ComPacT withdrawable devices	<b>33914</b>
1 ComPacT fixed + 1 ComPacT withdrawable device	<b>33915</b>
Push button cover (mandatory)	<b>2x 33897</b>

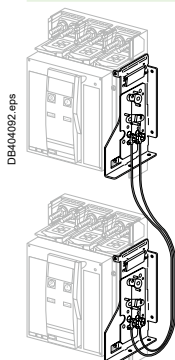

DB404092.eps

#### Associated controller

- The automatic-control option includes:
- an IVE electrical-interlocking unit
  - an ACP control plate
  - a BA or UA controller, depending on the required functions
  - a UA/BA adapter kit.

**Note:** the circuit breaker auxiliaries (MCH, MX, XF) and the automatic-control components (IVE, ACP, UA or BA) must have the same voltages.

#### TransferPacT Electrical Interlocking

IVE unit	24 to 250 V DC	48/415 V AC 50/60 Hz 440 V 60 Hz
For 2 devices	<b>29356</b>	<b>29352</b>
Wiring kit for connection of 2 fixed/withdrawable devices to the IVE unit		<b>54655</b>

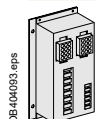

DB404093.eps

#### TransferPacT Controllers

Control unit	110/127 V AC 50/60 Hz	220/240 V AC 50/60 Hz	380/415 V AC 50/60 Hz 440 V 60 Hz
ACP + controller BA <sup>[1]</sup>		<b>29470</b>	<b>29471</b>
Plate ACP		<b>29363</b>	<b>29364</b>
Controller BA		<b>29376</b>	<b>29377</b>
ACP + controller UA <sup>[1]</sup>	<b>29448</b>	<b>29472</b>	<b>29473</b>
Plate ACP	<b>29447</b>	<b>29363</b>	<b>29364</b>
Controller UA	<b>29446</b>	<b>29378</b>	<b>29380</b>

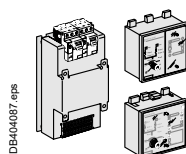

DB404097.eps

**[1]** The supply voltages of the UA/BA controller, ACP plate, IVE unit and circuit breaker operating mechanism must be identical whatever the type of source-changeover system.



# References of source-changeover systems for 2 devices

## MasterPacT MTZ1

### Circuit breakers and switch-disconnectors

#### Mechanical interlocking for source-changeover systems

##### Interlocking using connecting rods

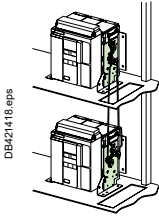

Complete assembly with 2 adaptation fixtures + rods	<b>33912</b>
2 MasterPacT MTZ1 fixed devices	<b>33913</b>
2 MasterPacT MTZ1 drawout devices	<b>2x LV833897</b>
Push button cover (mandatory)	

##### Interlocking using cables <sup>[1]</sup>

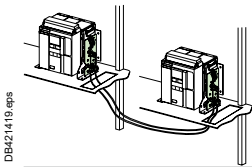

Choose 2 adaptation fixtures (1 for each breaker + 1 set of cables)	
1 adaptation fixture for MasterPacT MTZ1 fixed devices	<b>33200</b>
1 adaptation fixture for MasterPacT MTZ1 drawout devices	<b>33201</b>
1 set of 2 cables	<b>33209</b>
Push button cover (mandatory)	<b>2x LV833897</b>

#### Associated controller

- The automatic-control option includes:
- an IVE electrical-interlocking unit
  - an ACP control plate
  - a BA or UA controller, depending on the required functions
  - a UA/BA adapter kit.

**Note:** the circuit breaker auxiliaries (MCH, MX, XF) and the automatic-control components (IVE, ACP, UA or BA) must have the same voltages.

#### TransferPacT Electrical Interlocking

IVE unit	24 to 250 V DC	48/415 V AC 50/60 Hz 440 V 60 Hz
For 2 devices	<b>29356</b>	<b>29352</b>
Wiring kit for connection of 2 fixed/drawout devices to the IVE unit		<b>54655</b>

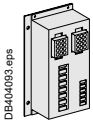

#### TransferPacT Controllers

Control unit	110/127 V AC 50/60 Hz	220/240 V AC 50/60 Hz	380/415 V AC 50/60 Hz 440 V 60 Hz
ACP + controller BA <sup>[2]</sup>		<b>29470</b>	<b>29471</b>
Plate ACP		<b>29363</b>	<b>29364</b>
Controller BA		<b>29376</b>	<b>29377</b>
ACP + controller UA <sup>[2]</sup>	<b>29448</b>	<b>29472</b>	<b>29473</b>
Plate ACP	<b>29447</b>	<b>29363</b>	<b>29364</b>
Controller UA	<b>29446</b>	<b>29378</b>	<b>29380</b>

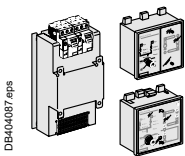

[1] Can be used with any combination of MTZ1 or MTZ2/MTZ3, fixed or drawout devices.

[2] The supply voltages of the UA/BA controller, ACP plate, IVE unit and circuit breaker operating mechanism must be identical whatever the type of source-changeover system.



# References of source-changeover systems for 2 devices

## MasterPacT MTZ2/MTZ3

### Circuit breakers and switch-disconnectors

#### Mechanical interlocking for source-changeover systems for 2 devices

##### Interlocking of 2 devices using connecting rods

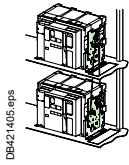

DB421405.eps

Complete assembly with 2 adaptation fixtures + rods	<b>48612</b>
2 MasterPacT MTZ2/MTZ3 fixed devices	<b>48612</b>
2 MasterPacT MTZ2/MTZ3 drawout devices	<b>2x LV848536</b>
Push button cover (mandatory)	
<b>Note:</b> Can be used with 1 MTZ2/MTZ3 fixed + 1 MTZ2/MTZ3 drawout.	

##### Interlocking of 2 devices using cables <sup>[1]</sup>

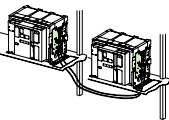

DB421408.eps

Choose 2 adaptation fixtures (1 for each breaker + 1 set of cables)	
1 adaptation fixture for MasterPacT MTZ2/MTZ3 fixed devices	<b>47926</b>
1 adaptation fixture for MasterPacT MTZ2/MTZ3 drawout devices	<b>47926</b>
1 set of 2 cables	<b>33209</b>
Push button cover (mandatory)	<b>2x LV848536</b>

#### Associated controller for 2 devices

The automatic-control option includes:

- an IVE electrical-interlocking unit
- an ACP control plate
- a BA or UA controller, depending on the required functions
- a UA/BA adapter kit.

**Note:** the circuit breaker auxiliaries (MCH, MX, XF) and the automatic-control components (IVE, ACP, UA or BA) must have the same voltages.

#### TransferPacT Electrical Interlocking

IVE unit	24 to 250 V DC	48/415 V AC 50/60 Hz 440 V 60 Hz
For 2 devices	<b>29356</b>	<b>29352</b>
Wiring kit for connection of 2 fixed/drawout devices to the IVE unit		<b>54655</b>

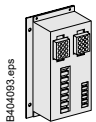

DB404033.eps

#### TransferPacT Controllers

Control unit	110/127 V AC 50/60 Hz	220/240 V AC 50/60 Hz	380/415 V AC 50/60 Hz 440 V 60 Hz
ACP + controller BA <sup>[2]</sup>		<b>29470</b>	<b>29471</b>
Plate ACP		<b>29363</b>	<b>29364</b>
Controller BA		<b>29376</b>	<b>29377</b>
ACP + controller UA <sup>[2]</sup>	<b>29448</b>	<b>29472</b>	<b>29473</b>
Plate ACP	<b>29447</b>	<b>29363</b>	<b>29364</b>
Controller UA	<b>29446</b>	<b>29378</b>	<b>29380</b>

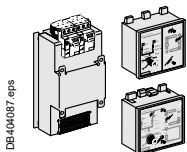

DB404037.eps

[1] Can be used with any combination of MTZ1 or MTZ2/MTZ3, fixed or drawout devices.

[2] The supply voltages of the UA/BA controller, ACP plate, IVE unit and circuit breaker operating mechanism must be identical whatever the type of source-changeover system.



## References of source-changeover systems for 3 devices

## MasterPacT MTZ2/MTZ3

## Circuit breakers and switch-disconnectors

## Mechanical interlocking for source-changeover systems for 3 devices

## Interlocking of 3 devices using cables

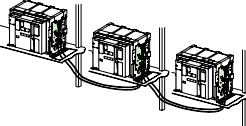
	Choose 3 adaptation fixtures (1 complete set with 3 adaptation fixtures + cables)	<b>48610</b>
	3 sources, only 1 device closed, fixed or drawout devices	<b>48609</b>
	2 sources, 1 coupling, fixed or drawout devices	<b>48608</b>
	2 normal, 1 replacement source, fixed or drawout devices	<b>3x LV848536</b>
	Push button cover (mandatory)	

DB421407.eps

# Order form for source-changeover systems for 2 devices

## Com**PacT** INS40 to INS630

### Switch-disconnectors

To indicate your choices, check the applicable square boxes  and enter the appropriate information in the rectangles .

Mechanical interlocking of two INS40 to INS630 devices  
 Devices with front rotary handles, mounted side by side

	Two devices with direct rotary handles		
	INS250	<input type="checkbox"/>	INS320/400/500/630 <input type="checkbox"/>
	Two devices with extended rotary handles		
	INS40/63/80	<input type="checkbox"/>	INS100/125/160 <input type="checkbox"/>
	INS250	<input type="checkbox"/>	INS320/400/500/630 <input type="checkbox"/>
Downstream coupling accessory	INS250	<input type="checkbox"/>	INS320/400/500/630 <input type="checkbox"/>
Long terminal shields	INS250	<input type="checkbox"/>	INS320/400/500/630 <input type="checkbox"/>



# Order form for source-changeover systems for 2 devices

## ComPacT INS40 to INS630

### Switch-disconnectors

To indicate your choices, check the applicable square boxes  and enter the appropriate information in the rectangles .  
(one sheet per device, make copies if necessary)

Device identification:

**Q 1 - NORMAL SOURCE**

**Q 2 - REPLACEMENT SOURCE**

Switch-disconnector

ComPacT type	<b>INS40/63/80</b>	<input type="checkbox"/>
	<b>INS100/125/160</b>	<input type="checkbox"/>
	<b>INS250</b>	<input type="checkbox"/>
	<b>INS320/400/500/630</b>	<input type="checkbox"/>
Rating	<b>A</b>	<input type="checkbox"/>
Number of poles	<b>3 or 4</b>	<input type="checkbox"/>

Connections

<b>Front connection</b>	Standard	<input type="checkbox"/>
<b>Rear connection</b>	2 short <input type="checkbox"/> 2 long <input type="checkbox"/>	<input type="checkbox"/>
INS40/80 connectors	Distribution 3x16 <sup>□</sup> rigid/10 <sup>□</sup> flexible	<input type="checkbox"/>
INS100/160 connectors	Snap-on ≤ 95 <sup>□</sup> Distribution 4x25 <sup>□</sup> rigid/16 <sup>□</sup> flexible	<input type="checkbox"/>
INS250 connectors	Snap-on 1.5 <sup>□</sup> to 95 <sup>□</sup> (< 160 A) Snap-on 10 <sup>□</sup> to 185 <sup>□</sup> (< 250 A) Volt. tap connector for 185 <sup>□</sup> connector Clips for connectors Set of 10	<input type="checkbox"/>
INS320/630 connectors	Distribution 6x1.5 <sup>□</sup> to 35 <sup>□</sup> rigid with interphase barriers 1 cable 35 <sup>□</sup> to 300 <sup>□</sup> 2 cables 35 <sup>□</sup> to 240 <sup>□</sup> Voltage tap connector for 185 <sup>□</sup> connector	<input type="checkbox"/>
Distribution blocks	Linergy DX 4P 125 A <input type="checkbox"/> 160 A <input type="checkbox"/> 1P 160 A <input type="checkbox"/> Linergy BS 160 A <input type="checkbox"/> 250 A <input type="checkbox"/> (multi stage) Linergy DP 250 A <input type="checkbox"/>	<input type="checkbox"/>
Rt-angle extension	Set of 3 or 4 250 A <input type="checkbox"/> 630 A <input type="checkbox"/>	<input type="checkbox"/>
Straight extension	INS250	<input type="checkbox"/>
Edgewise ext.	INS630	<input type="checkbox"/>
Spreader	INS250 (45 mm) Front alignment base INS320/630 52.5 mm <input type="checkbox"/> 70 mm <input type="checkbox"/> One-piece INS250 <input type="checkbox"/> INS630 <input type="checkbox"/>	<input type="checkbox"/>
Cu cable lugs supplied with 2 or 3 inter-phase barriers	INS100/160 For 95 <sup>□</sup> cable INS250 For 120 <sup>□</sup> cable For 150 <sup>□</sup> cable For 185 <sup>□</sup> cable INS320/630 For 240 <sup>□</sup> cable For 300 <sup>□</sup> cable	<input type="checkbox"/>
Al cable lugs supplied with 2 or 3 inter-phase barriers	INS250 For 150 <sup>□</sup> cable INS320/630 For 185 <sup>□</sup> cable For 240 <sup>□</sup> cable For 300 <sup>□</sup> cable	<input type="checkbox"/>
Terminal shrouds	INS40/63/80 <input type="checkbox"/> INS100/125/160 <input type="checkbox"/>	<input type="checkbox"/>
Terminal shields	INS40/63/80 <input type="checkbox"/> INS100/125/160 <input type="checkbox"/> INS250 Long <input type="checkbox"/> INS320/630 Long <input type="checkbox"/> Long for 52.5 mm spreaders <input type="checkbox"/>	<input type="checkbox"/>
Interphase barriers	INS100/160 Set of 6 <input type="checkbox"/> INS250 Set of 6 <input type="checkbox"/> INS320/630 Set of 6 <input type="checkbox"/>	<input type="checkbox"/>

Indication and measurements

4P ammeter module	For INS250	Rating	100 A	<input type="checkbox"/>
			150 A	<input type="checkbox"/>
			250 A	<input type="checkbox"/>
Adaptation kit required for direct handles	For INS320/630	Rating	400 A	<input type="checkbox"/>
			600 A	<input type="checkbox"/>
				<input type="checkbox"/>
4P current-transformer module	For INS250	Rating	100 A	<input type="checkbox"/>
			150 A	<input type="checkbox"/>
			250 A	<input type="checkbox"/>
	For INS320/630	Rating	400 A	<input type="checkbox"/>
			600 A	<input type="checkbox"/>
				<input type="checkbox"/>
Auxiliary contact	For INS40/160	1OF/CAF/CAO	Standard	<input type="checkbox"/>
			Low level	<input type="checkbox"/>
	For INS250/630	1 OF/CAM	Standard	<input type="checkbox"/>
			Low level	<input type="checkbox"/>

Rotary handles

Extended front handles	INS40 to INS160	Black	<input type="checkbox"/>	Red on yellow front	<input type="checkbox"/>
	INS250	Black	<input type="checkbox"/>	Red on yellow front	<input type="checkbox"/>
	INS320 to INS630	Black	<input type="checkbox"/>	Red on yellow front	<input type="checkbox"/>
	For complete changeover assembly	INS250	<input type="checkbox"/>		<input type="checkbox"/>
		INS320/630	<input type="checkbox"/>		<input type="checkbox"/>

Locking of rotary handles

Padlocking	1 to 3 padlocks (in OFF position)	<input type="checkbox"/>
Keylocking	Keylock adapter (keylock not included)	<input type="checkbox"/>
	Keylocks Ronis 1351B.500 <input type="checkbox"/> Profalux KS5 B24 D4Z	<input type="checkbox"/>

Installation accessories

Front-panel escutcheon	For switch-disconnectors	<input type="checkbox"/>
	For ammeter module, IP40	<input type="checkbox"/>

# Order form for source-changeover systems for 2 devices

## ComPacT NSX100 to NSX630

### Circuit breakers and switch-disconnectors

To indicate your choices, check the applicable square boxes  and enter the appropriate information in the rectangles .

#### Diagram for two ComPacT NSX devices

Without automatic control, without emergency off auxiliaries	(no. 51201177)	<input type="checkbox"/>
Without automatic control, with emergency off by MN	(no. 51201178)	<input type="checkbox"/>
Without automatic control, with emergency off by MX	(no. 51201179)	<input type="checkbox"/>

#### Mechanical interlocking of two NSX100 to NSX630 devices

**(fixed, plug-in)**

**Manually operated devices, mounted side by side:**

Two devices with toggles	<input type="checkbox"/>
Two devices with rotary handles	<input type="checkbox"/>

#### Mechanical and electrical interlocking of two NSX100 to NSX630 devices

**(fixed or plug-in)**

**Electrically operated devices, mounted side by side:**

Select 1 base plate + IVE unit, the 4 auxiliary contacts and the options / accessories

Base plate + IVE unit	Identical voltages:	48 to 415 V AC 50/60 Hz	<input type="checkbox"/>
	24 to 250 V DC	440/480 V AC 60 Hz	<input type="checkbox"/>
	"Normal" NSX100/250	"Replacement" NSX100/250	<input type="checkbox"/>
	"Normal" NSX400/630	"Replacement" NSX400/630	<input type="checkbox"/>
	"Normal" NSX400/630	"Replacement" NSX100/250	<input type="checkbox"/>
	Adapter kit for NSX400/630 with NSX100/250 (plug-in)		<input type="checkbox"/>
Auxiliary contacts	2 OF + 2 SDE (mandatory)	Quantity	<input type="text" value="4"/>
Options	Long rear connections	Plug-in base	<input type="checkbox"/>
Downstream coupling accessory (for fixed version)	3P	NSX100/250	<input type="checkbox"/>
	4P	NSX400/630	<input type="checkbox"/>
Prefabricated wiring	Between device and IVE	Quantity	<input type="text"/>

#### Automatic-control option

Power supply 220/240 V - 50/60 Hz:	ACP + BA controller	<input type="checkbox"/>
	ACP + UA controller	<input type="checkbox"/>
	ACP + UA150 controller	<input type="checkbox"/>
Power supply 380/415 V - 50/60 Hz and 440 V - 60 Hz:	ACP + BA controller	<input type="checkbox"/>
	ACP + UA controller	<input type="checkbox"/>
	ACP + UA150 controller	<input type="checkbox"/>



# Order form for source-changeover systems for 2 devices

## ComPacT NSX100 to NSX630

### Circuit breakers and switch-disconnectors

(One sheet per device, make copies if necessary)

**Name of customer:** \_\_\_\_\_  
**Address for delivery:** \_\_\_\_\_  
**Requested delivery date:** \_\_\_\_\_  
**Customer order no.:** \_\_\_\_\_

To indicate your choices, check the applicable square boxes and enter the appropriate information in the rectangles

**Q 1 - NORMAL SOURCE**   
**Q 2 - REPLACEMENT SOURCE**

**Circuit breaker or switch disconnecter**

ComPacT type **NSX100/160/250**  **NSX400/630**

Rating **A**

Circuit breaker **B, F, N, H, S, L**

Switch-discon. **NA**

No. of poles **2, 3 or 4**

No. of poles protected **2d, 3d or 4d**

Fixed device  Front connections

Plug-in/withdr. Plug-in  Withdrawable

Earth-leakage protection **ME, MH, MB**

Vigi module Voltage  **V**   
 4P option on 3P NSX

**Trip unit**

Thermal-mag. **TMD** rating (16 ... 250 A)   
**TMG** rating (16 ... 63 A)   
**MA** rating (2.5 ... 220 A)

Electronic **MicroLogic 2.2**  **MicroLogic 2.3**   
**MicroLogic 2.2 G**  **MicroLogic 2.3 AB**   
**MicroLogic 2.2 AB**  **MicroLogic 5.3 A**   
**MicroLogic 5.2 A**  **MicroLogic 5.3 E**   
**MicroLogic 5.2 E**  **MicroLogic 5.3 A-Z**   
**MicroLogic 5.2 A-Z**  **MicroLogic 6.3 A**   
**MicroLogic 6.2 A**  **MicroLogic 6.3 E**   
**MicroLogic 6.2 E**  **MicroLogic 1.3 M**   
**MicroLogic 2.2 M**  **MicroLogic 2.3 M**   
**MicroLogic 6.2 E-M**  **MicroLogic 6.3 E-M**   
**SDTAM** module

External neutral CT

24 V DC power supply connector

ZSI wiring accessory for NS630b **MTZ1/MTZ2/MTZ3**

External power supply module 24-30 V DC  48-60 V DC   
 100-125 V AC  110-130 V AC   
 24 V DC  200-240 V AC  380-415 V AC

Battery module

**Connection**

Rear-connection kit Short  Long   
 Mixed

NSX100/250 connectors Snap-on 1.5° to 95° (< 160 A)   
 Snap-on 25° to 95° (< 250 A)   
 Snap-on 120° to 185° (< 250 A)   
 Distribution 6 x 1.5° to 35°   
 Aluminium 2 cables 50° to 120°

NSX400/630 connectors 1 cable 35° to 300°   
 2 cables 35° to 240°

Right-angle terminal extensions

Straight extensions **NSX100/250**

Edgewise extensions  45° term. ext.  Dbl.-L term. ext.

Spreader **NSX100/250** (one piece)  (45 mm)   
**NSX400/630** (52.5 mm)  (70 mm)

Cu cable lugs **NSX100/250** 120°  150°  185°   
**NSX400/630** 240°  300°

Al cable lugs **NSX100/250** 150°  185°   
**NSX400/630** 240°  300°

V mesrt Input for connector For lugs NSX100/250 ≤ 185°   
 For lugs NSX400/630

Terminal shields **NSX100/250** Long   
**NSX400/630** Long

Interphase barriers Long for 52.5 mm spreaders  Set of 6

2 insulating scrn. **NSX100/250**  **NSX400/630** 70 pitch

**Test tool**

Pocket battery for MicroLogic

Maintenance case

USB maintenance interface

Power supply 110-240 V AC

Spare MicroLogic cord

**Indication and measurement**

Ammeter module Standard  3P  4P   
 I max  3P

Current-transformer module  3P  4P

Current-transformer module + TCU  3P  4P

Insulation-monitoring module  3P  4P

Voltage-presence indicator

Auxiliary contact OF  SD  SDE  SDV  Standard   
 OF  SD  SDE  SDV  Low level

SDE adapter (TM, MA or MicroLogic 2 trip units)

SDX module

**Remote operation**

Electrical operation Motor mechanism AC  DC  V   
 Voltage releases Instantaneous MX AC  DC  V   
 Instantaneous MN AC  DC  V   
 Fixed time delay MN AC  DC  V   
 Adjust. time delay MN AC  DC  V

**Rotary handles**

Direct Black  Red and yellow front   
 MCC conversion access.  CNOMO conversion access.

Extended Black  Red and yellow front   
 Telescopic handle for withdrawable device

Indication auxiliary 1 early-break switch  2 early-make switches

**Locking**

Toggle (1 to 3 padlocks) Removable  Fixed

Rotary handle Keylock adapter (keylock not included)   
 Keylocks Ronis 1351B.500  Profalux KS5 B24 D4Z

Motor mechanism Keylock adapter + keylock Ronis (special)  NSX100/250   
 Keylock adapter (keylock not included)  NSX400/630   
 Keylocks Ronis 1351B.500  Profalux KS5 B24 D4Z

**Interlocking**

Mechanical Toggle operated  Rotary Handle

By key (2 keylocks, 1 key) for rotary handle Locking kit without locks   
 Keylocks Ronis 1351B.500  Profalux KS5 B24 D4Z

**Installation accessories**

IP30 escutcheon for all types (toggle/rotary handle/motor mechanism)

IP30 escutcheon (with access to toggle + trip unit)

IP30 escutcheon for Vigi module

IP40 escutcheon for all types (toggle/rotary handle/motor mechanism)

IP40 escutcheon for Vigi module

IP40 escutcheon for Vigi or ammeter module

Toggle cover

Sealing accessories

DIN rail adapter

3P 60 mm busbar adapter

**Plug-in / withdrawable configuration accessories**

Auxiliary connections 1 automatic connector fixed part with 9 wires (for base)   
 1 automatic connector moving part with 9 wires (for circuit breaker)   
 1 sup. for 3 auto. conn. moving parts  1 sup. for 2 auto. conn.   
 9-wire manual auxiliary connector (fixed + moving)

Plug-in base accessories Long insulated terminals  Set of 2   
 2 IP4 shutters for base

Chassis accessories Escutcheon collar  Toggle  Vigi   
 Locking kit (keylock not included)   
 2 carriage switches (conn./disconnected position indication)

Parts or plug-in Plug-in base FC/RC 2P  3P  4P

Withdrawable kits Set of two power connections  Standard  Vigi   
 Safety trip for advanced opening   
 For 3P/4P chassis  Moving part   
 Fixed part

Adaptater for plug-in base (for terminal shield or interphase barriers)

**Communication**

NSX Cord L = 0.35 m  NSX Cord L = 1.3 m   
 NSX Cord U > 480 V AC L = 0.35 m  NSX Cord L = 3 m

BSCM (NSX400/630)

Communicating motor mechanism 220-240 V

Switchboard front display module FDM121

FDM mounting accessory

Modbus interface

Stacking accessory

ULP line termination

RJ45 connectors Wire length RJ45 L = 0.3 m  Wire length RJ45 L = 0.6 m   
 female/female Wire length RJ45 L = 1 m  Wire length RJ45 L = 2 m   
 Wire length RJ45 L = 3 m  Wire length RJ45 L = 5 m

# Order form for source-changeover systems for 2 devices

## ComPacT NS630b to NS1600

### Circuit breakers and switch-disconnectors

To indicate your choices, check the applicable square boxes  and enter the appropriate information in the rectangles .

Diagram for two ComPacT NS devices

**Electrical interlocking with lockout after fault:**

Permanent replacement source (with IVE unit)	(no. 51201183)	<input type="checkbox"/>
With emergency off by MX (with IVE unit)	(no. 51201184)	<input type="checkbox"/>
With emergency off by MN (with IVE unit)	(no. 51201185)	<input type="checkbox"/>

Interlocking using connecting rods between two NS630b to NS1600 devices

**Manually operated devices installed side-by-side:**

For two fixed NS devices with extended rotary handles

**Electrically operated devices installed one above the other:**

Select a complete set including two adaptation fixtures and the connecting rods

Complete set for:	2 fixed NS devices	<input type="checkbox"/>
	2 withdrawable NS devices	<input type="checkbox"/>

Interlocking using cables between two NS630b to NS1600 devices

**Electrically operated devices installed one above the other or side-by-side:**

Select a complete set including two adaptation fixtures and the cables

Complete set for:	2 fixed NS devices	<input type="checkbox"/>
	2 withdrawable NS devices	<input type="checkbox"/>
	1 fixed NS device + 1 withdrawable NS device	<input type="checkbox"/>

Electrical interlocking between two NS630b to NS1600 devices

1 IVE unit 48/415 V - 50/60 Hz and 440 V - 60 Hz	<input type="checkbox"/>
1 wiring kit for connection between 2 fixed / withdrawable devices to the IVE unit	<input type="checkbox"/>

Automatic-control option

Power supply 110 V - 50/60 Hz:	ACP + BA controller	<input type="checkbox"/>
	ACP + UA controller	<input type="checkbox"/>
	ACP + UA150 controller	<input type="checkbox"/>
Power supply 220/240 V - 50/60 Hz:	ACP + BA controller	<input type="checkbox"/>
	ACP + UA controller	<input type="checkbox"/>
	ACP + UA150 controller	<input type="checkbox"/>
Power supply 380/415 V - 50/60 Hz and 440 V - 60 Hz:	ACP + BA controller	<input type="checkbox"/>
	ACP + UA controller	<input type="checkbox"/>
	ACP + UA150 controller	<input type="checkbox"/>



# Order form for source-changeover systems for 2 devices

## ComPacT NS630b to NS1600

### Circuit breakers and switch-disconnectors

(One sheet per device, make copies if necessary)

**Name of customer:** \_\_\_\_\_  
**Address for delivery:** \_\_\_\_\_  
 \_\_\_\_\_  
**Requested delivery date:** \_\_\_\_\_  
**Customer order no.:** \_\_\_\_\_

To indicate your choices, check the applicable square boxes and enter the appropriate information in the rectangles

Device identification:  
**Q 1 - NORMAL SOURCE**   
**Q 2 - REPLACEMENT SOURCE**

#### Circuit breaker or switch disconnecter

ComPacT type	<b>NS630b to NS1600</b>	<input type="checkbox"/>
Rating	<b>A</b>	<input type="checkbox"/>
Circuit breaker	<b>N, H, L</b>	<input type="checkbox"/>
Switch-disconnector	<b>NA</b>	<input type="checkbox"/>
Number of poles	<b>3 or 4</b>	<input type="checkbox"/>
Device	Fixed <input type="checkbox"/>	
	Withdr. with chassis <input type="checkbox"/>	
	Withdr. without chassis <input type="checkbox"/>	
	(moving part only) <input type="checkbox"/>	
Chassis alone without connections		<input type="checkbox"/>

#### MicroLogic control unit

<b>Basic protection</b>	2.0	<input type="checkbox"/>	5.0	<input type="checkbox"/>	6.0	<input type="checkbox"/>	
<b>A - ammeter</b>	2.0	<input type="checkbox"/>	5.0	<input type="checkbox"/>	6.0	<input type="checkbox"/>	7.0 <input type="checkbox"/>
<b>E - energy meter</b>	2.0	<input type="checkbox"/>	5.0	<input type="checkbox"/>	6.0	<input type="checkbox"/>	
<b>P - power meter</b>			5.0	<input type="checkbox"/>	6.0	<input type="checkbox"/>	7.0 <input type="checkbox"/>
<b>AD - external power-supply module</b>							V <input type="checkbox"/>
<b>TCE - external sensor (CT) for neutral protection</b>							
Rectangular sensor	280 x 115 mm						
<b>TCW - external sensor for SGR protection</b>							
<b>LR - long-time rating plug</b>	Standard 0.4 to 1 Ir <input type="checkbox"/>						
	Low setting 0.4 to 0.8 Ir <input type="checkbox"/>						
	High setting 0.8 to 1 Ir <input type="checkbox"/>						
	LT OFF <input type="checkbox"/>						

#### Communication

<b>Eco COM module Modbus</b>	Device <input type="checkbox"/>	Chassis <input type="checkbox"/>
Front Display Module (FDM121)	<input type="checkbox"/>	Mounting accessory <input type="checkbox"/>
Breaker ULP cord	L = 0.35 m <input type="checkbox"/>	
	L = 1.3 m <input type="checkbox"/>	
	L = 3 m <input type="checkbox"/>	

#### Connections

<b>Horizontal rear connections</b>	Top <input type="checkbox"/>	Bottom <input type="checkbox"/>
<b>Vertical rear connections</b>	Top <input type="checkbox"/>	Bottom <input type="checkbox"/>
<b>Front connections</b>	Top <input type="checkbox"/>	Bottom <input type="checkbox"/>
4x240° bare cable connectors + shields	NS - FC fixed <input type="checkbox"/>	
Long connection shields	NS - FC fixed <input type="checkbox"/>	
Vertical-connection adapters	NS - FC fixed, withdr. <input type="checkbox"/>	
Cable-lug adapters	NS - FC fixed, withdr. <input type="checkbox"/>	
Arc chute screen	NS - FC fixed <input type="checkbox"/>	
Interphase barriers	NS - FC fixed, withdr. <input type="checkbox"/>	
Spreaders	NS - FC fixed, withdr. <input type="checkbox"/>	
VO - safety shutters on chassis	NS - FC fixed <input type="checkbox"/>	

#### Indication contacts

<b>SD trip indication (maximum 1)</b>	6 A-240 V AC <input type="checkbox"/>	Low level <input type="checkbox"/>
<b>SDE fault-trip indication (maximum 1) (SDE integrated in electrically operated devices)</b>	6 A-240 V AC <input type="checkbox"/>	Low level <input type="checkbox"/>
<b>OF ON/OFF indication contacts (maximum 3)</b>	6 A-240 V AC qty <input type="checkbox"/>	Low level qty <input type="checkbox"/>
<b>Carriage switches (possible combinations: 3 CE, 2 CD, 1 CT)</b>		
<b>CE - "connected" position</b>	6 A-240 V AC qty <input type="checkbox"/>	Low level qty <input type="checkbox"/>
<b>CD - "disconnected" position</b>	6 A-240 V AC qty <input type="checkbox"/>	Low level qty <input type="checkbox"/>
<b>CT - "test" position</b>	6 A-240 V AC qty <input type="checkbox"/>	Low level qty <input type="checkbox"/>
<b>Auxiliary terminals for chassis alone</b>	Jumpers (set of 10) <input type="checkbox"/>	
	3-wire terminal (30 parts) <input type="checkbox"/>	6-wire terminal (10 parts) <input type="checkbox"/>

#### Remote operation

<b>Electrical operation</b>	Standard <input type="checkbox"/>	Communicating <input type="checkbox"/>
<b>Power supply</b>	AC <input type="checkbox"/>	DC <input type="checkbox"/>
<b>Voltage releases</b>	MX AC <input type="checkbox"/>	DC <input type="checkbox"/>
	MN AC <input type="checkbox"/>	DC <input type="checkbox"/>
	MN delay unit <input type="checkbox"/>	Adjustable <input type="checkbox"/>
		Non-adjustable <input type="checkbox"/>

#### Rotary handles for fixed and withdrawable device

<b>Direct</b>	Black <input type="checkbox"/>	Red on yellow front <input type="checkbox"/>
		CNOMO conversion access. <input type="checkbox"/>
<b>Extended</b>	Black <input type="checkbox"/>	Red on yellow front <input type="checkbox"/>
	Telescopic handle for withdrawable device <input type="checkbox"/>	
<b>Indication auxiliary</b>	6 A-240 V AC <input type="checkbox"/>	2 early-make switches <input type="checkbox"/>
		2 early-break switches <input type="checkbox"/>

#### Locking

<b>Toggle (1 to 3 padlocks)</b>	Removable system <input type="checkbox"/>	Fixed system <input type="checkbox"/>
<b>Rotary handle using a keylock</b>	OFF position <input type="checkbox"/>	ON and OFF positions <input type="checkbox"/>
	Ronis 1351B.500 <input type="checkbox"/>	Profalux KS5 B24 D4Z <input type="checkbox"/>
	Keylock kit (without keylock) <input type="checkbox"/>	
<b>For electrically operated devices</b>	<b>VBP - ON/OFF pushbutton locking</b> <input type="checkbox"/>	
	OFF position locking:	
	<b>VCPO - by padlocks</b> <input type="checkbox"/>	
	<b>VSPO - by keylocks</b>	
	Keylock kit (w/o keylock)	Profalux <input type="checkbox"/>
	1 keylock	Profalux <input type="checkbox"/>
	2 identical keylocks, 1 key	Profalux <input type="checkbox"/>
		Ronis <input type="checkbox"/>
		Ronis <input type="checkbox"/>
<b>Chassis locking in "disconnected" position:</b>		
<b>VSPD - by keylocks</b>	Keylock kit (w/o keylock)	Profalux <input type="checkbox"/>
		Kirk <input type="checkbox"/>
	1 keylock	Profalux <input type="checkbox"/>
	2 identical keylocks, 1 key	Profalux <input type="checkbox"/>
	2 keylocks, different keys	Profalux <input type="checkbox"/>
		Ronis <input type="checkbox"/>
		Ronis <input type="checkbox"/>
	Optional connected/disconnected/test position locking <input type="checkbox"/>	
<b>VPEC - door interlock</b>		On right-hand side of chassis <input type="checkbox"/>
		On left-hand side of chassis <input type="checkbox"/>
<b>VPOC - racking interlock</b>		<input type="checkbox"/>
<b>VDC - mismatch protection</b>		<input type="checkbox"/>

#### Accessories

<b>CDM - mechanical operation counter</b>	<input type="checkbox"/>
<b>CDP - escutcheon</b>	<input type="checkbox"/>
<b>CP - transparent cover for escutcheon</b>	<input type="checkbox"/>
<b>OP - blanking plate for escutcheon</b>	<input type="checkbox"/>
Mounting brackets for fixed NS	For mounting on horizontal plane <input type="checkbox"/>
Test kits	Mini <input type="checkbox"/>
	Portable test kit <input type="checkbox"/>



# Order form for source-changeover systems for 2 devices

## MasterPacT MTZ1/MTZ2/MTZ3

### Circuit breakers and switch-disconnectors

To indicate your choices, check the applicable square boxes  and enter the appropriate information in the rectangles .

#### Diagram for 2 MasterPacT MTZ1/MTZ2/MTZ3 devices

##### Electrical interlocking with lockout after fault:

Permanent replacement source (with IVE unit)	<input type="checkbox"/>
With emergency off by MX (with IVE unit)	<input type="checkbox"/>
With emergency off by MN (with IVE unit)	<input type="checkbox"/>
<b>Automatic control with lockout after fault:</b>	
Permanent replacement source (with IVE unit)	<input type="checkbox"/>
Engine generator set (with IVE unit)	<input type="checkbox"/>

##### Interlocking using connecting rods (MTZ1/MTZ2/MTZ3 devices one above the other)

Select a complete set including two adaptation fixtures and the connecting rods

Complete set for:	2 drawout MTZ1	<input type="checkbox"/>	2 fixed MTZ1	<input type="checkbox"/>
	2 drawout MTZ2/3	<input type="checkbox"/>	2 fixed MTZ2/3	<input type="checkbox"/>
	1 fixed MTZ1 device + 1 fixed MTZ2/3 device	<input type="checkbox"/>		<input type="checkbox"/>
	1 drawout MTZ1 device + 1 drawout MTZ2/3 device	<input type="checkbox"/>		<input type="checkbox"/>

##### Interlocking using cables (MTZ1/MTZ2/MTZ3 devices one above the other or side-by-side)

Select two adaptation fixtures (one for each device) and a set of two cables

Adaptation fixture for:	1 fixed MTZ1 device	qty	<input type="checkbox"/>
(MTZ1/MTZ2/3 fixed and drawout devices may be mixed)	1 drawout MTZ1 device	qty	<input type="checkbox"/>
	1 fixed MTZ2/3 device	qty	<input type="checkbox"/>
	1 drawout MTZ2/3 device	qty	<input type="checkbox"/>
	1 set of 2 cables (for two devices)		<input type="checkbox"/>

##### Electrical interlocking 2 MasterPacT MTZ1/MTZ2/MTZ3 devices

1 IVE unit 48/415 V - 50/60 Hz and 440 V - 60 Hz	<input type="checkbox"/>
1 wiring kit for connection between 2 fixed / withdrawable devices to the IVE unit	<input type="checkbox"/>

##### Automatic-control option

Power supply 220/240 V - 50/60 Hz:	ACP + BA controller	<input type="checkbox"/>
	ACP + UA controller	<input type="checkbox"/>
	ACP + UA150 controller	<input type="checkbox"/>
Power supply 380/415 V - 50/60 Hz and 440 V - 60 Hz:	ACP + BA controller	<input type="checkbox"/>
	ACP + UA controller	<input type="checkbox"/>
	ACP + UA150 controller	<input type="checkbox"/>



# Order form for source-changeover systems for 2 devices

## MasterPacT MTZ1/MTZ2/MTZ3

### Circuit breakers and switch-disconnectors

(One sheet per device, make copies if necessary)

**Name of customer:** \_\_\_\_\_

**Address for delivery:** \_\_\_\_\_

**Requested delivery date:** \_\_\_\_\_

**Customer order no.:** \_\_\_\_\_

To indicate your choices, check the applicable square boxes and enter the appropriate information in the rectangles

Device identification:

**Q 1 - NORMAL SOURCE**

**Q 2 - REPLACEMENT SOURCE**

**Circuit breaker or switch disconnecter**

MasterPacT type	MTZ1	MTZ2/MTZ3
Rating	<b>A</b>	<input type="checkbox"/>
Sensor rating	<b>A</b>	<input type="checkbox"/>
Circuit breaker	<b>N1, H1, H2, H3, L1</b>	<input type="checkbox"/>
Switch-disconnector	<b>NA, HA, HF, ES, HA10 (MTZ2/3)</b>	<input type="checkbox"/>
Number of poles	<b>3 or 4</b>	<input type="checkbox"/>
Option: neutral on right side	<input type="checkbox"/>	<input type="checkbox"/>
Device	Fixed <input type="checkbox"/>	<input type="checkbox"/>
	Withdr. with chassis <input type="checkbox"/>	<input type="checkbox"/>
	Withdr. without chassis (moving part only) <input type="checkbox"/>	<input type="checkbox"/>
Chassis alone without connections	<input type="checkbox"/>	<input type="checkbox"/>

**MicroLogic control unit**

<b>LI</b>	<input type="checkbox"/>	<b>2.X</b>	<input type="checkbox"/>
<b>LSI</b>	<input type="checkbox"/>	<b>5.X</b>	<input type="checkbox"/>
<b>LSIG</b>	<input type="checkbox"/>	<b>6.X</b>	<input type="checkbox"/>
<b>LSIV</b>	<input type="checkbox"/>	<b>7.X</b>	<input type="checkbox"/>
<b>AD</b> - external power-supply module	<input type="checkbox"/>	<b>V</b>	<input type="checkbox"/>
<b>TCE</b> - external sensor (CT) for neutral protection	<input type="checkbox"/>		<input type="checkbox"/>
Rectangular sensor for earth-leakage protection	MTZ1 (280 x 115 mm) <input type="checkbox"/>		<input type="checkbox"/>
	MTZ2/3 (470 x 160 mm) <input type="checkbox"/>		<input type="checkbox"/>
<b>LR</b> - long-time rating plug	Standard 0.4 to 1 Ir <input type="checkbox"/>		<input type="checkbox"/>
	Low setting 0.4 to 0.8 Ir <input type="checkbox"/>		<input type="checkbox"/>
	High setting 0.8 to 1 Ir <input type="checkbox"/>		<input type="checkbox"/>
	LT OFF <input type="checkbox"/>		<input type="checkbox"/>
<b>PTE</b> - external voltage measurement input (required for reverse supply)	<input type="checkbox"/>		<input type="checkbox"/>
<b>BAT</b> - battery module	<input type="checkbox"/>		<input type="checkbox"/>

**Communication**

Eco COM module	Modbus	Device	Chassis
Front Display Module (FDM121)	<input type="checkbox"/>	Mounting accessory	<input type="checkbox"/>
Breaker ULP cord		L = 0.35 m <input type="checkbox"/>	<input type="checkbox"/>
		L = 1.3 m <input type="checkbox"/>	<input type="checkbox"/>
		L = 3 m <input type="checkbox"/>	<input type="checkbox"/>
ULP port	<input type="checkbox"/>		IFM <input type="checkbox"/>
ULP cord	<input type="checkbox"/>		EIFE <input type="checkbox"/>
I/O module	<input type="checkbox"/>		FDM128 <input type="checkbox"/>
IFE	<input type="checkbox"/>		<input type="checkbox"/>

**Connections**

<b>Horizontal</b>	Top <input type="checkbox"/>	Bottom <input type="checkbox"/>
<b>Vertical</b>	Top <input type="checkbox"/>	Bottom <input type="checkbox"/>
<b>Front</b>	Top <input type="checkbox"/>	Bottom <input type="checkbox"/>
Vertical-connection adapters	MTZ1 - FC fixed, draw. <input type="checkbox"/>	
Cable-lug adapters	MTZ1 - FC fixed, draw. <input type="checkbox"/>	
Arc chute screen	MTZ1 - FC fixed <input type="checkbox"/>	
Interphase barriers	MTZ1 - MTZ2/3 fixed, draw. <input type="checkbox"/>	
Spreaders	MTZ1 fixed, drawout <input type="checkbox"/>	
Disconnectable front connection adapter	MTZ2/3 fixed <input type="checkbox"/>	
Lugs for 240° or 300° cables	MTZ2/3 fixed, drawout <input type="checkbox"/>	
<b>VO</b> - safety shutters on chassis	MTZ1, MTZ2/3 <input type="checkbox"/>	<b>X</b>
<b>VIVC</b> - shutter position indication and locking	MTZ2/3 <input type="checkbox"/>	<input type="checkbox"/>

### Indication contacts

**OF - ON/OFF indication contacts**

Standard	4 OF 6 A-240 V AC (10 A-240 V AC and low-level for MTZ2/3)		
Additional	1 block of 4 OF for MTZ2/3	max. 2	qty <input type="checkbox"/>
<b>EF - combined "connected/closed" contacts</b>			
	1 EF 6 A-240 V AC for MTZ2/3	max. 8	qty <input type="checkbox"/>
	1 EF low-level for MTZ2/3	max. 8	qty <input type="checkbox"/>
<b>SDE - "fault-trip" indication contact</b>			
Standard	1 SDE 6 A-240 V AC		
Additional	1 SDE 6 A-240 V AC <input type="checkbox"/>	1 SDE Low level <input type="checkbox"/>	
<b>Programmable contacts</b>			
Carriage switches	6 A-240 V AC <input type="checkbox"/>	2 M2C contacts <input type="checkbox"/>	
		Low level <input type="checkbox"/>	
<b>CE</b> - "connected" position	max. 3 for MTZ2/3 / MTZ1		qty <input type="checkbox"/>
<b>CD</b> - "disconnected" position	max. 3 for MTZ2/3, 2 for MTZ1		qty <input type="checkbox"/>
<b>CT</b> - "test" position	max. 3 for MTZ2/3, 1 for MTZ1		qty <input type="checkbox"/>
<b>AC</b> - MTZ2/3 actuator for 6 CE - 3 CD - 0 CT additional carriage switches			qty <input type="checkbox"/>

### Remote operation

**Remote ON/OFF**

<b>MCH</b> - gear motor	<input type="checkbox"/>	<b>V</b>	<input type="checkbox"/>
<b>XF</b> - closing voltage release	<input type="checkbox"/>	<b>V</b>	<input type="checkbox"/>
<b>MX</b> - opening voltage release	<input type="checkbox"/>	<b>V</b>	<input type="checkbox"/>
<b>PF</b> - "ready to close" contact	Low level 6 A-240 V AC <input type="checkbox"/>		<input type="checkbox"/>
<b>BPFE</b> - electrical closing pushbutton	<input type="checkbox"/>		<input type="checkbox"/>
<b>Res</b> - electrical reset option	<input type="checkbox"/>	<b>V</b>	<input type="checkbox"/>
<b>RAR</b> - automatic reset option	<input type="checkbox"/>		<input type="checkbox"/>
<b>Remote tripping</b>			
<b>MN</b> - undervoltage release	<input type="checkbox"/>	<b>V</b>	<input type="checkbox"/>
<b>R</b> - delay unit (non-adjustable)	<input type="checkbox"/>		<input type="checkbox"/>
<b>Rr</b> - adjustable delay unit	<input type="checkbox"/>		<input type="checkbox"/>
<b>2<sup>nd</sup> MX</b> - shunt release	<input type="checkbox"/>	<b>V</b>	<input type="checkbox"/>

### Locking

**VBP** - ON/OFF pushbutton locking (by transparent cover + padlocks)

**OFF position locking:**

**VCPO** - by padlocks

**VSP0** - by keylocks

Keylock kit (w/o keylock)	Profalux <input type="checkbox"/>	Ronis <input type="checkbox"/>
1 keylock	Kirk <input type="checkbox"/>	Castell <input type="checkbox"/>
2 identical keylocks, 1 key	Profalux <input type="checkbox"/>	Ronis <input type="checkbox"/>
2 keylocks, different keys (MTZ2/3)	Profalux <input type="checkbox"/>	Ronis <input type="checkbox"/>

**Chassis locking in "disconnected" position:**

**VSPD** - by keylocks

Keylock kit (w/o keylock)	Profalux <input type="checkbox"/>	Ronis <input type="checkbox"/>
1 keylock	Kirk <input type="checkbox"/>	Castell <input type="checkbox"/>
2 identical keylocks, 1 key	Profalux <input type="checkbox"/>	Ronis <input type="checkbox"/>
2 keylocks, different keys	Profalux <input type="checkbox"/>	Ronis <input type="checkbox"/>
Optional connected/disconnected/test position locking		

**VPEC** - door interlock

On right-hand side of chassis

On left-hand side of chassis

**VPOC** - racking interlock

**IPA** - cable-type door interlock

**IBPO** - racking interlock between crank and OFF pushbutton for MTZ2/3

**DAE** - automatic spring discharge before breaker removal for MTZ2/3

**VDC** - mismatch protection device - chassis

### Accessories

**CDM** - mechanical operation counter

**CB** - auxiliary terminal shield for chassis

**CDP** - escutcheon

**CP** - transparent cover for escutcheon

**OP** - blanking plate for escutcheon

Brackets for mounting MTZ2/3 fixed  On backplates



# Order form for source-changeover systems for 3 devices

## MasterPacT MTZ2/MTZ3

### Circuit breakers and switch-disconnectors

To indicate your choices, check the applicable square boxes  and enter the appropriate information in the rectangles .

(one sheet per device, make copies if necessary)

Device identification:

**Q 1 - NORMAL SOURCE**

**Q 2 - REPLACEMENT SOURCE**

#### Circuit breaker or switch-disconnector

MasterPacT type	<b>MTZ2/MTZ3</b>	<input type="checkbox"/>
Rating	<b>A</b>	<input type="checkbox"/>
Sensor rating	<b>A</b>	<input type="checkbox"/>
Circuit breaker	<b>N1, H1, H2, H3, L1</b>	<input type="checkbox"/>
Switch-disconnector	<b>NA, HA, HF</b>	<input type="checkbox"/>
Number of poles	<b>3 or 4</b>	<input type="checkbox"/>
Option: neutral on right side		<input type="checkbox"/>
Device	Fixed	<input type="checkbox"/>
	Drawout with chassis	<input type="checkbox"/>
	Drawout without chassis (moving part only)	<input type="checkbox"/>
Chassis alone without connections		<input type="checkbox"/>

#### MicroLogic control unit

<b>LI</b>	<b>2.X</b>	<input type="checkbox"/>
<b>LSI</b>	<b>5.X</b>	<input type="checkbox"/>
<b>LSIG</b>	<b>6.X</b>	<input type="checkbox"/>
<b>LSIV</b>	<b>7.X</b>	<input type="checkbox"/>
<b>AD</b> - external power-supply module	<b>V</b>	<input type="checkbox"/>
<b>TCE</b> - external sensor (CT) for neutral protection		<input type="checkbox"/>
Rectangular sensor	470 x 160 mm	<input type="checkbox"/>
for earth-leakage protection		<input type="checkbox"/>
<b>TCW</b> - external sensor for SGR protection		<input type="checkbox"/>
<b>LR</b> - long-time rating plug	Standard 0.4 to 1 Ir	<input type="checkbox"/>
	Low setting 0.4 to 0.8 Ir	<input type="checkbox"/>
	High setting 0.8 to 1 Ir	<input type="checkbox"/>
	LT OFF	<input type="checkbox"/>
<b>PTE</b> - external voltage measurement input (required for reverse supply)		<input type="checkbox"/>
<b>BAT</b> - battery module		<input type="checkbox"/>

#### Communication

<b>Eco COM module</b> Modbus	Device	<input type="checkbox"/>	Chassis	<input type="checkbox"/>
Front Display Module (FDM121)	Mounting accessory	<input type="checkbox"/>		<input type="checkbox"/>
Breaker ULP cord	L = 0.35 m	<input type="checkbox"/>		<input type="checkbox"/>
	L = 1.3 m	<input type="checkbox"/>		<input type="checkbox"/>
	L = 3 m	<input type="checkbox"/>		<input type="checkbox"/>
ULP port		<input type="checkbox"/>	IFM	<input type="checkbox"/>
ULP cord		<input type="checkbox"/>	EIFE	<input type="checkbox"/>
I/O module		<input type="checkbox"/>	FDM128	<input type="checkbox"/>
IFE		<input type="checkbox"/>		<input type="checkbox"/>

#### Connections

<b>Horizontal</b>	Top	<input type="checkbox"/>	Bottom	<input type="checkbox"/>
<b>Vertical</b>	Top	<input type="checkbox"/>	Bottom	<input type="checkbox"/>
<b>Front</b>	Top	<input type="checkbox"/>	Bottom	<input type="checkbox"/>
Interphase barriers	Fixed, drawout	<input type="checkbox"/>		<input type="checkbox"/>
Disconnectable front connection adapter	Fixed	<input type="checkbox"/>		<input type="checkbox"/>
<b>VO</b> - safety shutters on chassis		<input checked="" type="checkbox"/>		<input type="checkbox"/>
<b>VIVC</b> - shutter position indication and locking		<input type="checkbox"/>		<input type="checkbox"/>

#### Indication contacts

<b>OF - ON/OFF indication contacts</b>			
Standard	4 OF 6 A-240 V AC (10 A-240 V AC and low-level)		
Additional	1 block of 4 OF	max. 2	qty <input type="checkbox"/>
<b>EF - combined "connected/closed" contacts</b>			
	1 EF 6 A-240 V AC	max. 8	qty <input type="checkbox"/>
	1 EF low-level	max. 8	qty <input type="checkbox"/>
<b>SDE - "fault-trip" indication contact</b>			
Standard	1 SDE 6 A-240 V AC		
Additional	1 SDE 6 A-240 V AC	<input type="checkbox"/>	1 SDE Low level <input type="checkbox"/>
<b>Programmable contacts</b>			
			2 M2C contacts <input type="checkbox"/>
Carriage switches	6 A-240 V AC	<input type="checkbox"/>	Low level <input type="checkbox"/>
<b>CE</b> - "connected" position	Max. 3		qty <input type="checkbox"/>
<b>CD</b> - "disconnected" position	Max. 3		qty <input type="checkbox"/>
<b>CT</b> - "test" position	Max. 3		qty <input type="checkbox"/>
<b>AC</b> - MTZ2/3 actuator for 6 CE - 3 CD - 0 CT additional carriage switches			qty <input type="checkbox"/>

#### Remote operation

<b>Remote ON/OFF</b>	<b>MCH</b> - gear motor	<b>V</b>	<input type="checkbox"/>	
	<b>XF</b> - closing voltage release	<b>V</b>	<input type="checkbox"/>	
	<b>MX</b> - opening voltage release	<b>V</b>	<input type="checkbox"/>	
	<b>PF</b> - "ready to close" contact	Low level	<input type="checkbox"/>	
		6 A-240 V AC	<input type="checkbox"/>	
	<b>BPFE</b> - electrical closing pushbutton		<input type="checkbox"/>	
	<b>Res</b> - electrical reset option	<b>V</b>	<input type="checkbox"/>	
	<b>RAR</b> - automatic reset option		<input type="checkbox"/>	
	<b>Remote tripping</b>	<b>MN</b> - undervoltage release	<b>V</b>	<input type="checkbox"/>
		<b>R</b> - delay unit (non-adjustable)		<input type="checkbox"/>
<b>Rr</b> - adjustable delay unit			<input type="checkbox"/>	
<b>2<sup>eme</sup> MX</b> - shunt release		<b>V</b>	<input type="checkbox"/>	

#### Locking

<b>VBP</b> - ON/OFF pushbutton locking (by transparent cover + padlocks)				<input type="checkbox"/>	
<b>OFF position locking:</b>					
<b>VCPO</b> - by padlocks					
<b>VSP0</b> - by keylocks	Keylock kit (w/o keylock)	Profalux	<input type="checkbox"/>	Ronis	<input type="checkbox"/>
		Kirk	<input type="checkbox"/>	Castell	<input type="checkbox"/>
	1 keylock	Profalux	<input type="checkbox"/>	Ronis	<input type="checkbox"/>
	2 identical keylocks, 1 key	Profalux	<input type="checkbox"/>	Ronis	<input type="checkbox"/>
	2 keylocks (MTZ2/3)	Profalux	<input type="checkbox"/>	Ronis	<input type="checkbox"/>
<b>Chassis locking in "disconnected" position:</b>					
<b>VSPD</b> - by keylocks	Keylock kit (w/o keylock)	Profalux	<input type="checkbox"/>	Ronis	<input type="checkbox"/>
		Kirk	<input type="checkbox"/>	Castell	<input type="checkbox"/>
	1 keylock	Profalux	<input type="checkbox"/>	Ronis	<input type="checkbox"/>
	2 identical keylocks, 1 key	Profalux	<input type="checkbox"/>	Ronis	<input type="checkbox"/>
	2 keylocks, different keys	Profalux	<input type="checkbox"/>	Ronis	<input type="checkbox"/>
	Optional connected/disconnected/test position locking				
<b>VPEC</b> - door interlock		On right-hand side of chassis			<input type="checkbox"/>
		On left-hand side of chassis			<input type="checkbox"/>
<b>VPOC</b> - racking interlock				<input type="checkbox"/>	
<b>IPA</b> - cable-type door interlock				<input type="checkbox"/>	
<b>IBPO</b> - racking interlock between crank and OFF pushbutton for MTZ2/3				<input type="checkbox"/>	
<b>DAE</b> - automatic spring discharge before breaker removal for MTZ2/3				<input type="checkbox"/>	
<b>VDC</b> - mismatch protection				<input type="checkbox"/>	

#### Accessories

<b>CDM</b> - mechanical operation counter	<input type="checkbox"/>
<b>CB</b> - auxiliary terminal shield for chassis	<input type="checkbox"/>
<b>CDP</b> - escutcheon	<input type="checkbox"/>
<b>CP</b> - transparent cover for escutcheon	<input type="checkbox"/>
<b>OP</b> - blanking plate for escutcheon	<input type="checkbox"/>
Brackets for mounting MTZ2/3 fixed	On backplates <input type="checkbox"/>



Life Is On | **Schneider**  
Electric

**Schneider Electric Industries SAS**

35, rue Joseph Monier  
CS 30323  
92506 Rueil Malmaison Cedex  
France

RCS Nanterre 954 503 439  
Capital social 928 298 512 €  
[www.se.com](http://www.se.com)

09-2022

© 2022 - Schneider Electric. All Rights Reserved.  
All trademarks are owned by Schneider Electric Industries SAS or its affiliated companies.  
Document reference: LVPED216028EN