

**Form Number D5139**  
Part Number D301709X012  
August 2015

# IEC 62591 Wireless Interface Instruction Manual



## Revision Tracking Sheet

### August 2015

This manual may be revised periodically to incorporate new or updated information. The revision date of each page appears at the bottom of the page opposite the page number. A change in revision date to any page also changes the date of the manual that appears on the front cover. Listed below is the revision date of each page (if applicable):

<b>Page</b>	<b>Revision</b>
All	August-2015
All	August-2014
All	August-2012
Initial issue	July-2012

# Chapter 1 – General Information

## In This Chapter

---

1.1	Scope of Manual .....	1-2
1.2	Hardware .....	1-2
1.2.1	IEC 62591 Wireless Interface Module.....	1-2
1.2.2	Smart Wireless Field Link.....	1-3
1.2.3	<i>WirelessHART</i> Field Devices .....	1-4
1.3	Configuration/Commissioning Software .....	1-5
1.4	Additional Technical Information.....	1-5

---

This manual covers both the hardware – the IEC 62591 Wireless Interface module for the ControlWave Micro device and the Smart Wireless Field Link – and the software you need to configure and commission the hardware components.

This chapter details the structure of this manual and provides an overview of the IEC 62591 Wireless Interface and its components.

---

**Note:** The IEC 62591 Wireless Interface uses open source software. Refer to *Open Source Software Listing* (Form A6330, included in the same .zip file as this manual) for a complete listing of all components. Source code is available upon request. You may obtain a copy of this source code by contacting Remote Automation Solutions Technical Support.

---

**Overview** The International Electrotechnical Commission’s 62591 standard (commonly called *WirelessHART*<sup>®</sup>) is a global IEC-approved standard that specifies an interoperable self-organizing mesh technology in which field devices form wireless networks that dynamically mitigate obstacles in the process environment. This architecture creates a cost-effective automation alternative that does not require wiring and other supporting infrastructure.

Remote Automation Solutions’ IEC 62591 implementation consists of an IEC 62591 Wireless Interface module installed in a ControlWave Micro RTU. The module is wired to a field-installed Smart Wireless Field Link. The wiring powers the Smart Wireless Field Link and transmits data between the Smart Wireless Field Link and a number of field-installed *WirelessHART* devices. The ControlWave implementation supports up to 100 devices. (See *Figure 1-1*, which shows a ControlWave Micro, a Smart Wireless Field Link, and several *WirelessHART* devices).

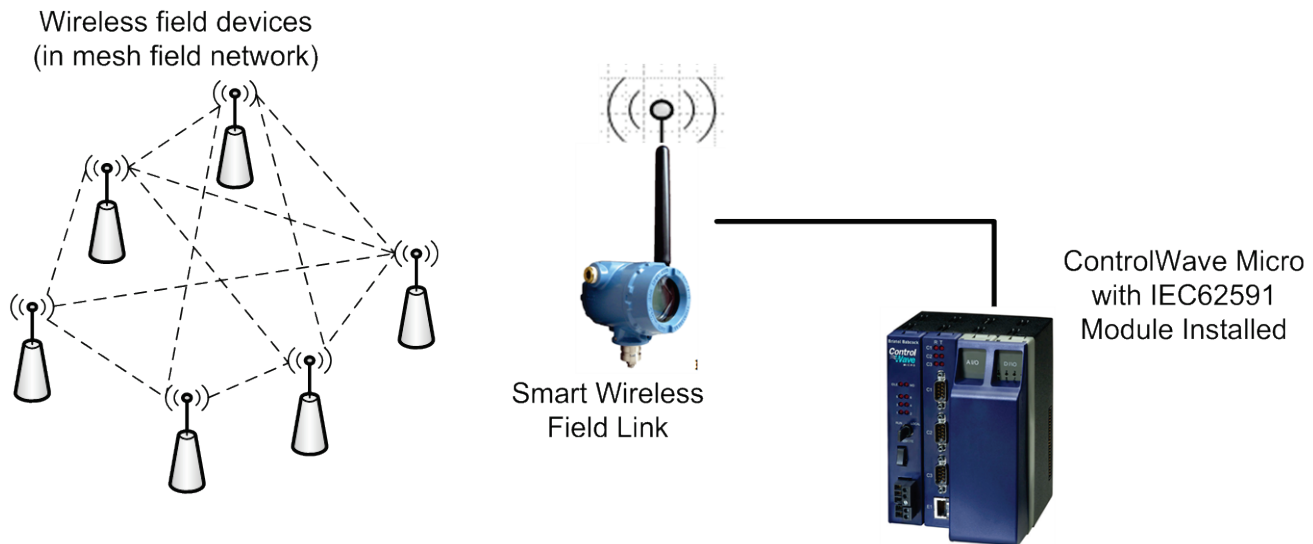

*Figure 1-1. IEC 62591 Field Installation*

## 1.1 Scope of Manual

This manual contains the following chapters:

Chapter 1 General Information	Provides an overview of the hardware for the IEC 62591 Wireless Interface.
Chapter 2 Installation	Provides information on installing the IEC 62591 Wireless Interface modules, installing the Smart Wireless Field Link, and wiring the Smart Wireless Field Link to the module.
Chapter 3 Configuring and Commissioning	Provides information on using ControlWave Designer to configure and commission the Wireless Interface.
Chapter 4 Troubleshooting	Provides general troubleshooting tips.

## 1.2 Hardware

The IEC 62591 Wireless Interface has two basic components: the IEC 62591 Wireless Interface module (“module”) and the Smart Wireless Field Link (“Field Link”).

### 1.2.1 IEC 62591 Wireless Interface Module

The IEC 62591 module has the standard appearance of a ControlWave Micro module (see *Figure 1-2*).

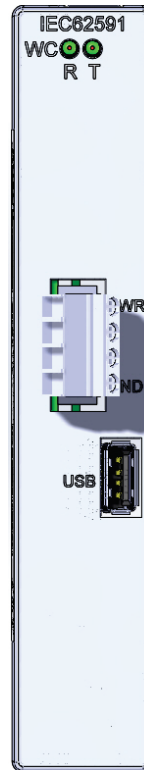

Figure 1-2. IEC 62591 Wireless Interface Module

You can place the module in any open I/O slot on the ControlWave Micro **except**, due to a mechanical restriction, it cannot reside in the last slot of any housing. Each ControlWave Micro can support only **one** IEC 62591 Wireless Interface module.

You **cannot** use the IEC 62591 with the ControlWave Micro Distributed I/O System.

---

**Note:** For information on installing modules in the ControlWave Micro, refer to the *ControlWave Micro Instruction Manual* (part D301392X012).

---

**USB Port** The module's USB port supports firmware upgrades and provides debug information for product support.

### 1.2.2 Smart Wireless Field Link

The second component in the Wireless Interface is the Smart Wireless Field Link (or “field link”; see *Figure 1-3*). You install the field link away from controller in the optimal location for best network performance. A 4-wire connection between the module and field link provides the 12-30 Vdc power the field link requires and transmits communication signals sent to the field link from the various *WirelessHART* field devices.



Figure 1-3. Smart Wireless Field Link

For instructions on installing the Smart Wireless Field Link, refer to *Chapter 2, Installation*.

### 1.2.3 **WirelessHART Field Devices**

The two components of Remote Automation Solutions' IEC 62591 Wireless Interface provide you with the ability to manage data from a network of *WirelessHART* field devices. Remote Automation Solutions supports transmitters that conform to the *WirelessHART* protocol. The physical configuration of the IEC 62591 Wireless Interface is based on the ControlWave Micro and the total number of field devices. A ControlWave Micro implementation supports up to 100 devices.

---

**Note:** The IEC 62591 Wireless Interface Module is designed to return the process and dynamic variables (PV, SV, TV, QV, slot 0, 1, 2, 3) from any device which meets the IEC 62591 specification (HCF\_SPEC-285, Revisions 2.0). Review the product data sheet (available on our [website](#)) to see a current list of the devices which Emerson has tested and supports with the interface. If you have a *WirelessHART* device which does not appear in the product data sheet consult with the manufacturer of the device to determine whether the process variable values you want to collect are available through the PV, SV, TV, QV and slot 0, 1, 2, and 3. If the device meets the discrete control specification, it should work with the IEC 62591 Wireless Interface; alternatively, it may be treated like an analog wireless device. Always test any *WirelessHART* devices not listed to see whether they work with the IEC 62591 Wireless Interface **before** you install them in the field.

---

### 1.3 Configuration/Commissioning Software

---

Once you have installed the modules and wired them to the Smart Wireless Field Link, you use ControlWave Designer and either AMS Device Configurator (a component of Emerson Process Management Field Tools) or a 375/475 Field Communicator to configure and then commission (“activate”) the entire network. Refer to *Chapter 3, Configuring and Commissioning*, for specific instructions.

### 1.4 Additional Technical Information

---

Refer to the following documents for additional technical information:

**Note:** The most current versions of these technical publications are available at [www.EmersonProcess.com/Remote](http://www.EmersonProcess.com/Remote).

---

*Table 1-1. Additional Technical Information*

Name	Form Number	Part Number
ControlWave Micro IEC 62591 Interface	CWM:62591	D301714X012
Emerson Process Management Field Tools Quick Start Guide	D5141	D301703X412

*[This page is intentionally left blank.]*



## Chapter 2 – Installation

### In This Chapter

2.1	Installing the IEC 62591 Module.....	2-1
2.2	Installing the Smart Wireless Field Link.....	2-2
2.2.1	Optimizing the Location.....	2-2
2.2.2	Positioning the Antenna .....	2-2
2.2.3	Mounting the Field Link .....	2-3
2.3	Wiring the Module and Field Link .....	2-4
2.3.1	Wiring the Field Link.....	2-4
2.3.2	Wiring the IEC 62591 Module .....	2-5
2.4	Configuring Wireless Devices for the Network .....	2-7
2.5	Preparing for Configuration and Commissioning.....	2-10

This chapter describes installing the IEC 62591 module in a ControlWave Micro, installing the Smart Wireless Field Link, and connecting the Smart Wireless Field Link to the IEC 62591 Wireless Interface module.

**Note:** This chapter covers the physical installation process. To configure and commission the IEC 62591 Wireless Interface, refer to *Chapter 3, Configuring and Commissioning*.

### 2.1 Installing the IEC 62591 Module

You install the IEC 62591 Wireless Interface module in the ControlWave Micro as you would any other module. However, you can install only one IEC 62591 module.

#### Notes:

- Only ControlWave Micro's with 05.50 (or newer) system firmware support the IEC 62591 module. Version 5.70 (or newer) system firmware is required for discrete control.
- You can install the IEC 62591 module in any I/O slot (slot 3 or higher **except** for the last slot in any chassis/housing) in the ControlWave Micro. You **cannot** use the IEC 62591 with the ControlWave Micro Distributed I/O System.

1. Disconnect power from the ControlWave Micro.
2. Choose an open I/O slot (except for the last slot of any housing).
3. Locate the built-in guides on the top and bottom of the housing.
4. Gently slide the IEC 62591 module into the housing until it seats into the connectors on the interior back of the housing.
5. Restore power to the unit.

## 2.2 Installing the Smart Wireless Field Link

This section covers where and how to install the Smart Wireless Field Link.

### 2.2.1 Optimizing the Location

Mount the Field Link in a location that provides convenient access to the host system network (wireless I/O devices) and the network of wireless field devices. Find a location where the Field Link has optimal wireless performance. Ideally, this is 4.6 to 7.6 m (15-25 ft) above the ground or 2 m (6 ft) above obstructions or major infrastructures. See *Figure 2-1*.

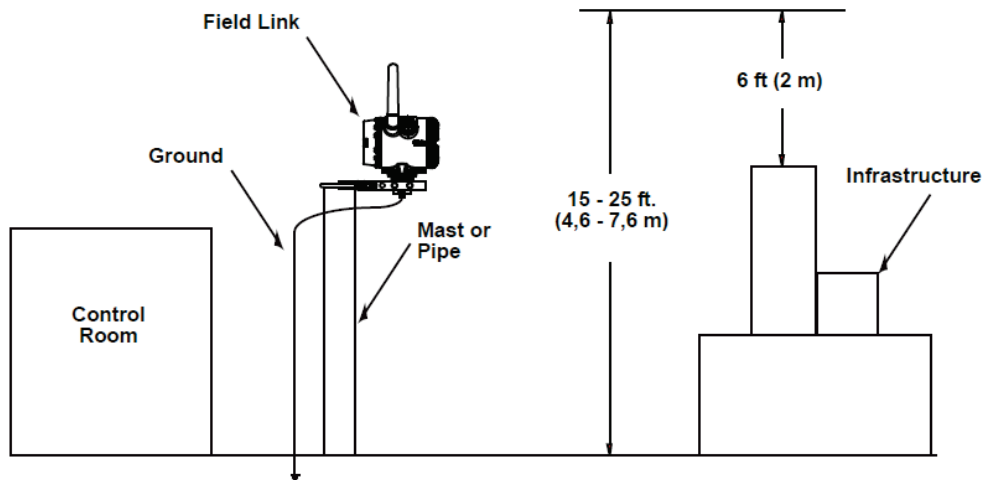

*Figure 2-1. Mounting the Field Link*

### 2.2.2 Positioning the Antenna

Position the antenna vertically, either straight up or straight down, approximately 1 m (3 ft) from any large structure, building, or conductive surfaces to allow clear communication with other devices. See *Figure 2-2*.

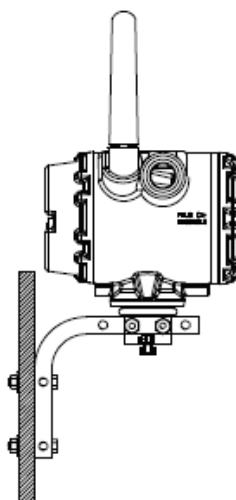
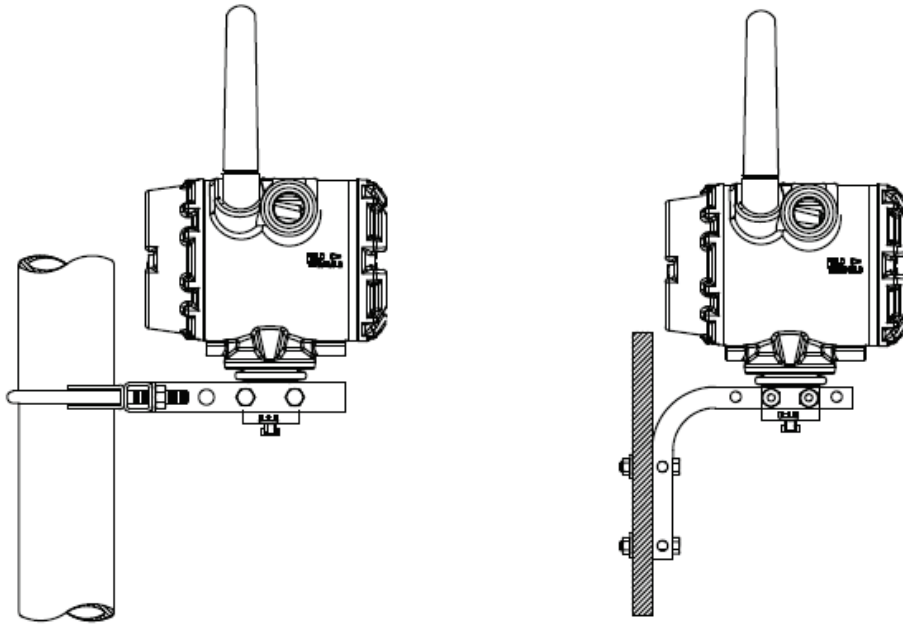

Figure 2-2. Antenna Position

### 2.2.3 Mounting the Field Link

You typically mount the Field Link on a pipe or mast using the clamps provided in the kit (see *Figure 2-3*).

1. Attach the L-shaped bracket to the pipe or mast.
  - For **pipe** installations, insert the larger U-bolt around the 2-in. pipe, through the L-shaped bracket, and through the washer plate (see the left side of *Figure 2-3*). Use a ½-in. socket-head wrench to secure the nuts to the U-bolt.
  - For **mast** installations, bolt the L-shaped bracket securely to the mast (see the right side of *Figure 2-3*).
2. Insert the smaller U-bolt around the base of the Field Link and through the L-shaped bracket.
3. Use a ½-in. socket-head wrench to fasten the nuts to the U-bolt.



*Figure 2-3. Field Link Mounting*

---

## 2.3 Wiring the Module and Field Link

---

This section assumes you have already installed the IEC 62591 module in the ControlWave Micro **and** installed the Smart Wireless Field Link in its permanent field location.

Communications between the IEC 62591 module and the Field Link occur through an RS-485 connection. Remote Automation Solutions recommends that you use shielded, twisted-pair cable for I/O signal wiring. The twisted-pair minimizes signal errors caused by electromagnetic interference (EMI), Radio Frequency Interference (RFI), and transients. The removable terminal blocks on the module accept wire sizes up to 14 AWG.

---

**Note:** Ensure that wiring between the ControlWave Micro IEC 62591 module and the Smart Wireless Field Link meets all appropriate local requirements (use of conduit, etc.).

---

### 2.3.1 Wiring the Field Link

1. Power down the IEC 62591 module (if it is currently powered).
2. Remove the housing cover identified on the casing as “Field Terminals.”
3. Connect the positive power lead to the “+” power terminal and the negative power lead to the “-” power terminal.
4. Connect the data + lead to the “A (+)” terminal and the data – lead to the “B (-)” terminal (see *Figure 2-4*).

5. Plug and seal any unused conduit connectors.
6. Replace the housing cover.

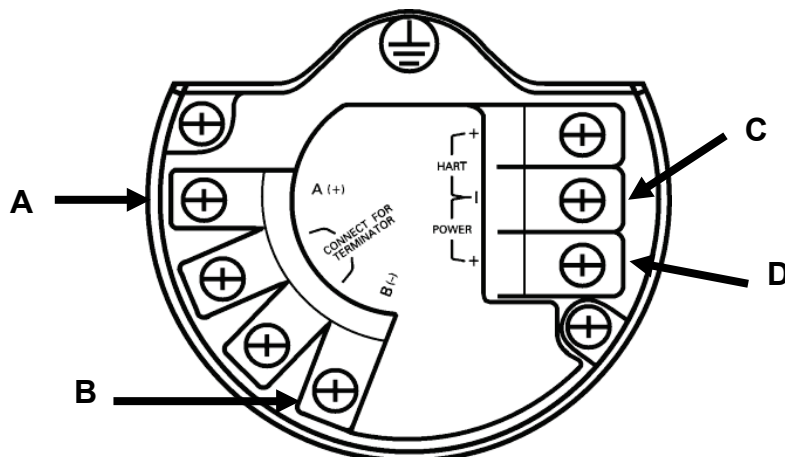

- A. Data A (+)
- B. Data B (-)
- C. Return
- D. +10.5 to 30 Vdc

*Figure 2-4. Field Link Power and Data Wiring*

### 2.3.2 Wiring the IEC 62591 Module

*Figure 2-5* provides a wiring diagram for the IEC 62591 module.

You must connect an RS-485 cable between the RS-485 port on the module, and the Smart Wireless Field Link. This requires a Belden 2-twisted pair cable. *Table 2-1* shows connections for the twisted pair cable. You must also connect termination jumper wires as shown in *Figure 2-6*.

Table 2-1. RS-485 Cable Connections

Smart Wireless Field Link	IEC 62591 Module
A(+)	A
B(-)	B
POWER -	GND
POWER +	PWR

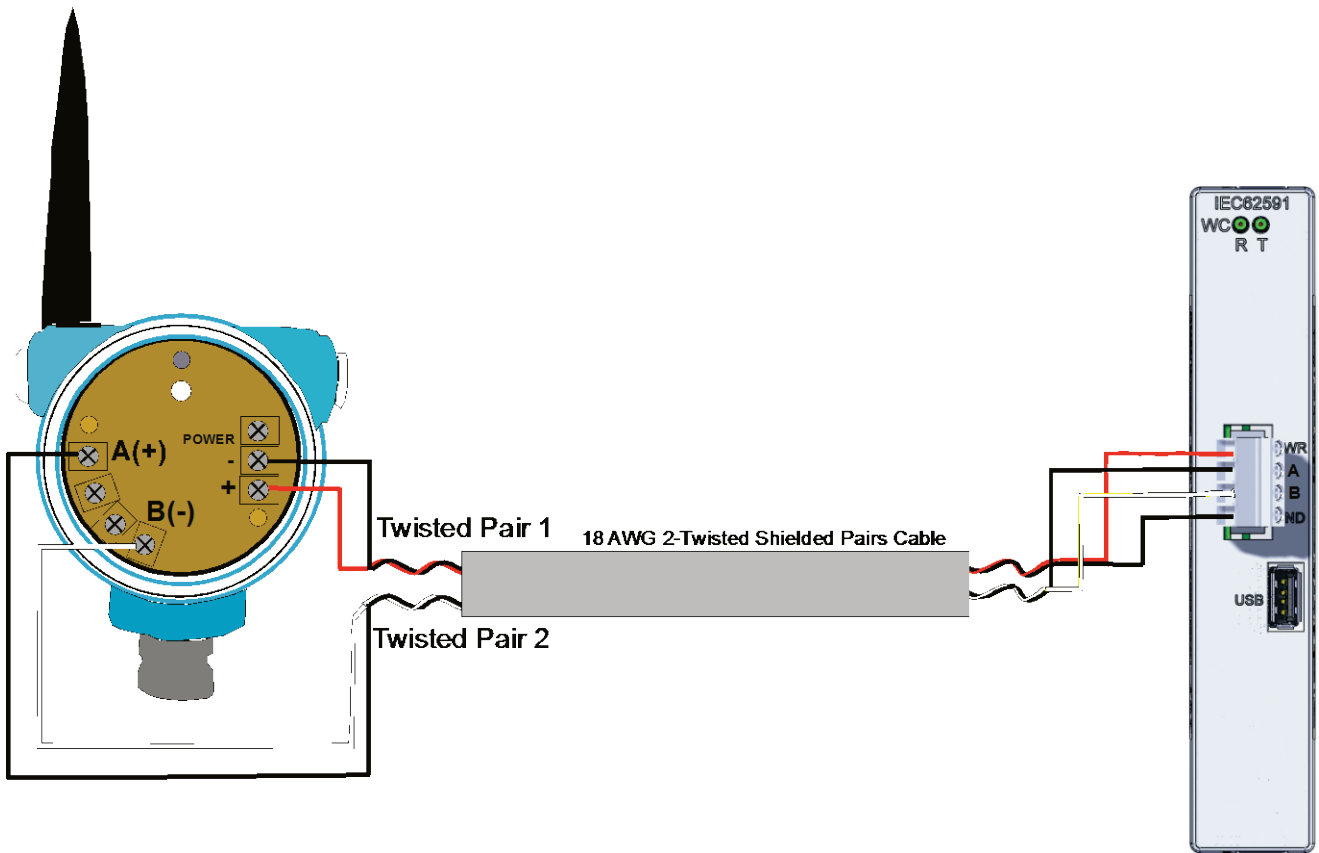

Figure 2-5. IEC 62591 Module Power and Data Wiring

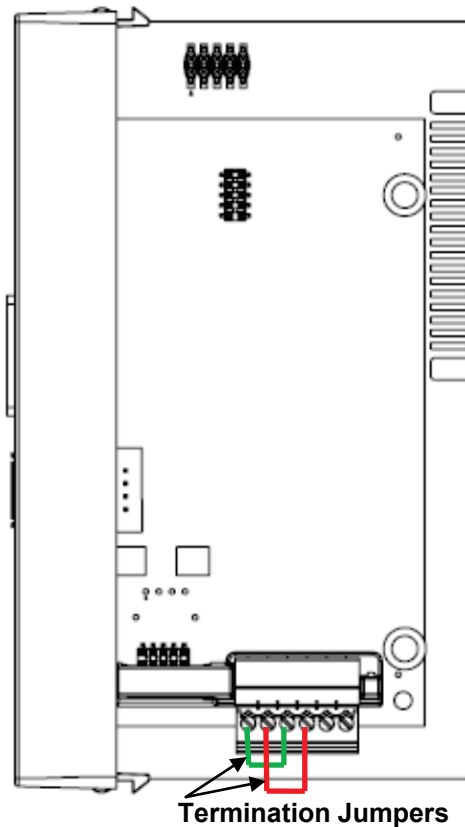

Figure 2-6. IEC 62591 Module – Connecting Termination Jumpers

## 2.4 Configuring Wireless Devices for the Network

See the product data sheet (available on our [website](#)) for a list of devices Emerson has tested with the IEC 62591 Wireless Interface.

You must configure the following for each device in the wireless network:

- A long tag name which is unique in the wireless network
- A Network ID (must be the same for every device in the wireless network)
- A Join Key (must be same for every device in the wireless network)

---

### **Caution**

**Configure all devices belonging to a site to use the same Network ID and join key. To avoid network errors, configure all devices in adjacent networks to use a different Network ID and join key.**

---

You configure these using the 375 or 475 Field Communicator or using AMS Device Configurator (a component of Field Tools software). If you have AMS Device Configurator software, see its online help for details on how to do this.

Basic instructions for setting the long tag, Network ID and Join Key using the 375 Field Communicator are included below; see the Field Communicator user manual if you need more information.

1. Connect the Field Communicator clips to the communication connectors on the wireless device, and turn the communicator on.

From the Main Menu, double-tap **HART Application**.

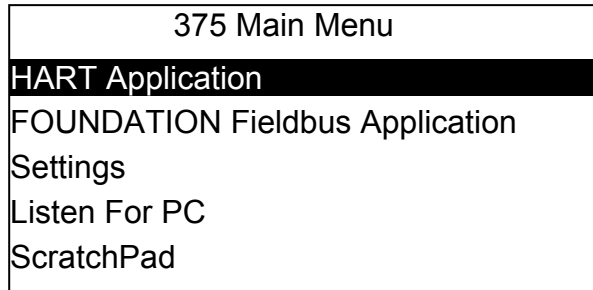

2. When the HART application detects the device you want to configure, double-tap on it.

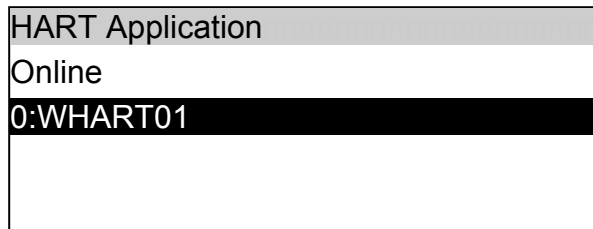

3. From the Online Menu, double-tap **Configure**.

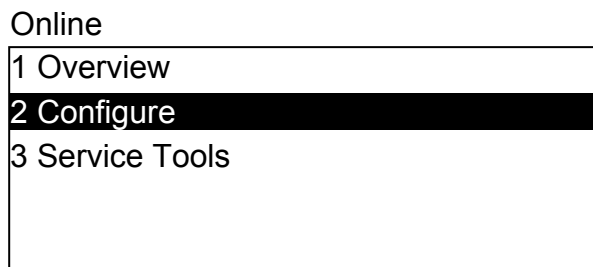

4. From the Configure Menu, double-tap **Manual Setup**.

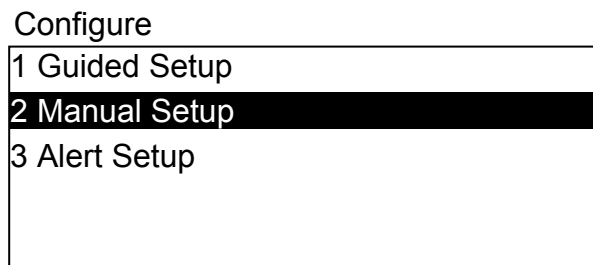



5. From the Manual Setup Menu, double-tap **Wireless**.

## Manual Setup

- |                       |
|-----------------------|
| 1 Wireless            |
| 2 Process Sensor      |
| 3 Percent of Range    |
| 4 Device Temperatures |
| 5 Device Information  |
| 6 Device Display      |
| 7 Other               |

6. From the Wireless Menu, double-tap either:
- Network ID** to set the Network ID using the on-screen keypad.
  - Join Device to Net...** to set the Join Key using the on-screen keypad.

## Wireless

- |                         |
|-------------------------|
| 1 Network ID            |
| 2 Join Device to Net... |
| 3 Broadcast Rates       |
| 4 Configure Broadca...  |
| 5 Power Mode            |
| 6 Power Source          |

7. From the Manual Setup Menu (shown in Step 7), double-tap **Device Information** to call up the Device Information menu, then choose **Long Tag** to set the long tag using the on-screen keypad.

## Device Information

- |            |
|------------|
| 1 Tag      |
| 2 Long Tag |
| 3 Device   |
| 4 Sensor   |
| 5 Wireless |

8. When you're finished with your configuration, tap **SAVE**, and choose to save the changes to the Internal Flash memory of the device and tap **SAVE** again.

## Save as...

- |               |                |
|---------------|----------------|
| 1 Location    | Internal Flash |
| 2 Name        | WHART01        |
| 3 Config Type | Device         |

## **2.5 Preparing for Configuration and Commissioning**

---

Once you have completed the wiring between the Field Link and the ControlWave Micro, re-attach the plastic bezel covers and apply power to the ControlWave Micro.

Proceed to *Chapter 3*.

## Chapter 3 – Configuration and Commissioning

### In This Chapter

3.1	Overview .....	3-2
3.1.1	Configuring Devices and Planning the Network.....	3-2
3.1.2	Network ID and Join Key.....	3-3
3.1.3	Rosemount THUM™ Adapter.....	3-3
3.1.4	Active List and Commission List.....	3-4
3.2	IEC 62591 Sample Program(s).....	3-4
3.2.1	Before You Begin .....	3-5
3.2.2	Accessing the IEC 62591 Sample Program(s).....	3-5
3.2.3	Modifying the IEC62591_STRUCTS Datatypes Worksheet .....	3-7
	ACTIVE_DEVICES_ARRAY datatype .....	3-7
	COMMISSION_ARRAY_DISCRETE datatype -or-.....	3-7
	INACTIVE_STAT_ARRAY and LAST_STATE_ARRAY datatypes .....	3-8
3.2.4	ErrorCatch Function Block (OPTIONAL).....	3-8
3.2.5	Modifying the DevData Function Block (OPTIONAL).....	3-8
3.2.6	Modifying the ACT_LIST Function Block (OPTIONAL).....	3-10
3.2.7	Configuring the Commission List.....	3-11
3.2.8	Specifying the Join Key .....	3-12
3.2.9	Specifying the Network ID and Slot Number .....	3-13
3.2.10	Configuring the Statistics List (OPTIONAL) .....	3-13
3.2.11	Generating Alarms Based on IEC62591 Function Block Status (OPTIONAL).....	3-14
3.2.12	Additional Programming Notes.....	3-14
3.3	Commissioning Wireless Devices.....	3-15
3.3.1	Active Advertising.....	3-16
3.4	Decommissioning or Replacing Wireless Devices .....	3-16
3.5	WirelessHART Data Access and Statistics .....	3-16
3.5.1	WirelessHART Data Access.....	3-16
3.5.2	WirelessHART Communication Statistics .....	3-18
3.6	Upgrading Firmware in the IEC 62591 Wireless Interface Module .....	3-18

In addition to wiring the Field Link to the IEC 62591 module and applying power to the module, you need to configure your ControlWave project to access the wireless network so it can discover and commission each *WirelessHART* device in the entire network. You also need to individually configure each *WirelessHART* device that will belong in the network with a unique long tag name and a common Network ID and common Join Key.

**Note:** Refer to the *Emerson Process Management Field Tools Quick Start Guide* (part D301703X412) for instructions on using AMS Device Configurator to configure the *WirelessHART* devices with the long tag name, Network ID, and Join Key.

Keep in mind that configuration and commissioning is a two-step process for **each** device:

- One step is to configure each device using Field Tools' AMS Device Configurator and a HART modem (or you can use a hand-held configuration device such as the Emerson 375 or 475 Field Communicator. During this step you individually add network information (Network ID, Join Key, and long tag name) to the field-based wireless device.
- The other step is to use ControlWave Designer to program the ControlWave Micro so it can detect the network and activate (or "commission") each device.

## 3.1 Overview

As indicated previously, a wireless interface network consists of a number of wireless devices, a Smart Wireless Field Link, and an IEC 62591 module installed in a ControlWave Micro. The IEC 62591 module can communicate with a maximum of 100 wireless devices; the actual number allowed for a given application varies depending upon the burst rate. An eight second burst rate allows the full number of 100 devices, a faster burst rate, say one second, reduces the number of devices allowed.

For the configuration and commissioning tasks described in this chapter, we use a PC running ControlWave Designer.



Figure 3-1. Wireless Interface

### 3.1.1 Configuring Devices and Planning the Network

Before you can use a *WirelessHART* device, you must first configure it. For this task you may use Field Tools' AMS Device Configurator and a HART modem (or you can use a field communicator (such as Emerson's 375 or 475 Field Communicator. Ideally, you commission individual devices at a workbench in a protected environment; although you can field-commission a device you might add to the network. During the configuration, you identify the Network ID to which the device eventually belongs and provide the network-specific Join Key (see *Network ID and Join Key*).

During configuration, you must also give the wireless device a unique long tag name based on its use or location (such as *PMPITEMP*, *PMP2PRES*, or *WEL02LVL*).

---

**Notes:**

- Tag names must not exceed 32 characters, and the tag name must be unique for this wireless network.
- You must configure the tag name as a **long tag name**. All references to tag names in this manual refer to the long tag name.
- We recommend you use all CAPITAL LETTERS for the tag names to avoid confusion since that is how they are stored internally.

---

The individual devices should fit into a general organizational plan for your fields. By identifying logical groups and pre-assigning devices to those groups, you can eliminate guesswork during commissioning, efficiently define networks, and more quickly begin to acquire data.

---

**Note:** An important restriction in planning networks is to know that a network can have only **one** Network ID, **one** Join Key, **one** Field Link, and **one** controller (a ControlWave Micro supporting up to 100 devices).

---

### 3.1.2 Network ID and Join Key

A five character Network ID defines one logical grouping of *WirelessHART* devices, all of which send their information to one Field Link. (You define a device's Network ID when you first configure the device.) Valid values for the Network ID range from 1 to 36863.

---

**Note:** A Network ID or Join Key **cannot** be all zeros (such as 00000).

---

The Join Key is the password that allows a device to access its defined network. During configuration, you also provide the device with its network-specific Join Key. When you configure your ControlWave project using ControlWave Designer, you will need to know the Network ID and Join Key for this network.

### 3.1.3 Rosemount THUM™ Adapter

---

**Note:** Each THUM adapter supports only one wired HART device.

---

Rosemount's THUM™ Adapter provides wireless connectivity to a wired HART device. If you have already commissioned a wired HART device into your network and want to connect it to a THUM Adapter, you must first decommission the device, attach the THUM Adapter, and then re-commission the device. For further information about THUM Adapters, refer to:

- *Smart Wireless THUM™ Adapter Reference Manual*, 00809-0100-4075, Rev CA, March 2014

- *Smart Wireless THUM™ Adapter Quick Installation Guide*, 00825-0100-4075, Rev DA, July 2011.

---

**Note:** The Quick Installation Guide was packed in the box with the THUM; the Reference Manual is available on the Rosemount website ([www.EmersonProcess.com/Rosemount](http://www.EmersonProcess.com/Rosemount)).

---

### 3.1.4 Active List and Commission List

When the Smart Wireless Field Link detects a wireless device that has the correct Network ID and Join Key, the IEC 62591 program running in the ControlWave Micro stores information about that device in a structure called the Active List. The Active List represents the entire network of wireless devices from which the Smart Wireless Field Link could potentially collect process variable data.

The program compares tag names for devices in the Active List to another structure called the Commission List. If a device in the Active List has a matching tag name in the Commission List, and its associated decommission flag is FALSE, the program stores configuration and process variable data for the device in the Commission List. The device is then considered to be “commissioned” as an active device in the network.

## 3.2 IEC 62591 Sample Program(s)

---

The ControlWave Designer software includes sample IEC 62591 programs that you can refer to or modify when creating your own IEC 62591-capable application. Alternatively, you can copy all the POU's, structures, and variables from one of the sample IEC 62591 programs into an existing ControlWave Designer project.

The sample programs include the IEC62591 function block, as well as structure and type definitions needed for the commission list, active list, and statistics list.

---

**Note:** For details on specific parameters in the IEC62591 function block, please refer to the ACCOL3 online help in ControlWave Designer.

---

### 3.2.1 Before You Begin

---

**Note:** Some of the structure data types used in the IEC 62591 sample programs have changed over time to add functionality. In particular, ControlWave Micro firmware version 5.70 includes modifications for discrete control functionality that make ControlWave projects built to run with version 5.60 firmware incompatible with 5.70. To upgrade these applications, you must replace the COMMISSION\_ARRAY and COMMISSION\_POINT structure data types with the COMMISSION\_ARRAY\_DISCRETE and COMMISSION\_POINT\_DISCRETE structure data types, and then re-compile the projects. These new data type definitions are available in the ACCOL3 Online Help for the IEC62591 function block in 5.70 or in the IEC62591\_DIO\_Example.zwt sample project. You do not need to modify your application if you are not upgrading the existing firmware (version 5.60 or earlier).

---

In addition to familiarity with ControlWave Designer programming, you will need to know the following information prior to modifying one of the sample programs.

- The Network ID for the wireless network
- The Join Key for the wireless network
- The unique long tag names assigned to each wireless device
- The slot number in the ControlWave Micro that holds the IEC 62591 module
- The maximum number of wireless devices in your wireless network. We recommend you specify a maximum number that includes room for growth of the network, in case you add a few more devices later.

### 3.2.2 Accessing the IEC 62591 Sample Program(s)

1. Start ControlWave Designer.
2. Click **File >Open Project/Unzip Project**
3. If not already there, navigate to the OpenBSI/Projects area and open one of the IEC62591 sample projects.

*Table 3-1. IEC 62591 Sample Programs*

Sample Program Name	Description
IEC62591_DIO_Example.zwt	Addition of support for discrete control. (Use with CW Micro firmware 5.70 or newer)
IEC62591_Example.zwt	Original version of IEC 62591 sample project (Use with CW Micro firmware 5.60 or earlier)

**Notes:**

- The structures and names shown in the following sections are representative of the original IEC 62591\_Example.zwt project; subsequent sample projects may have variations in names but the purpose of the basic structures and variables (commission list, active list, join key, etc.) remains the same.
  - See the program comments in the sample projects for the most current information.
4. When you open the project, you can see the project tree. *Figure 3-2* shows the different worksheets in the project tree.

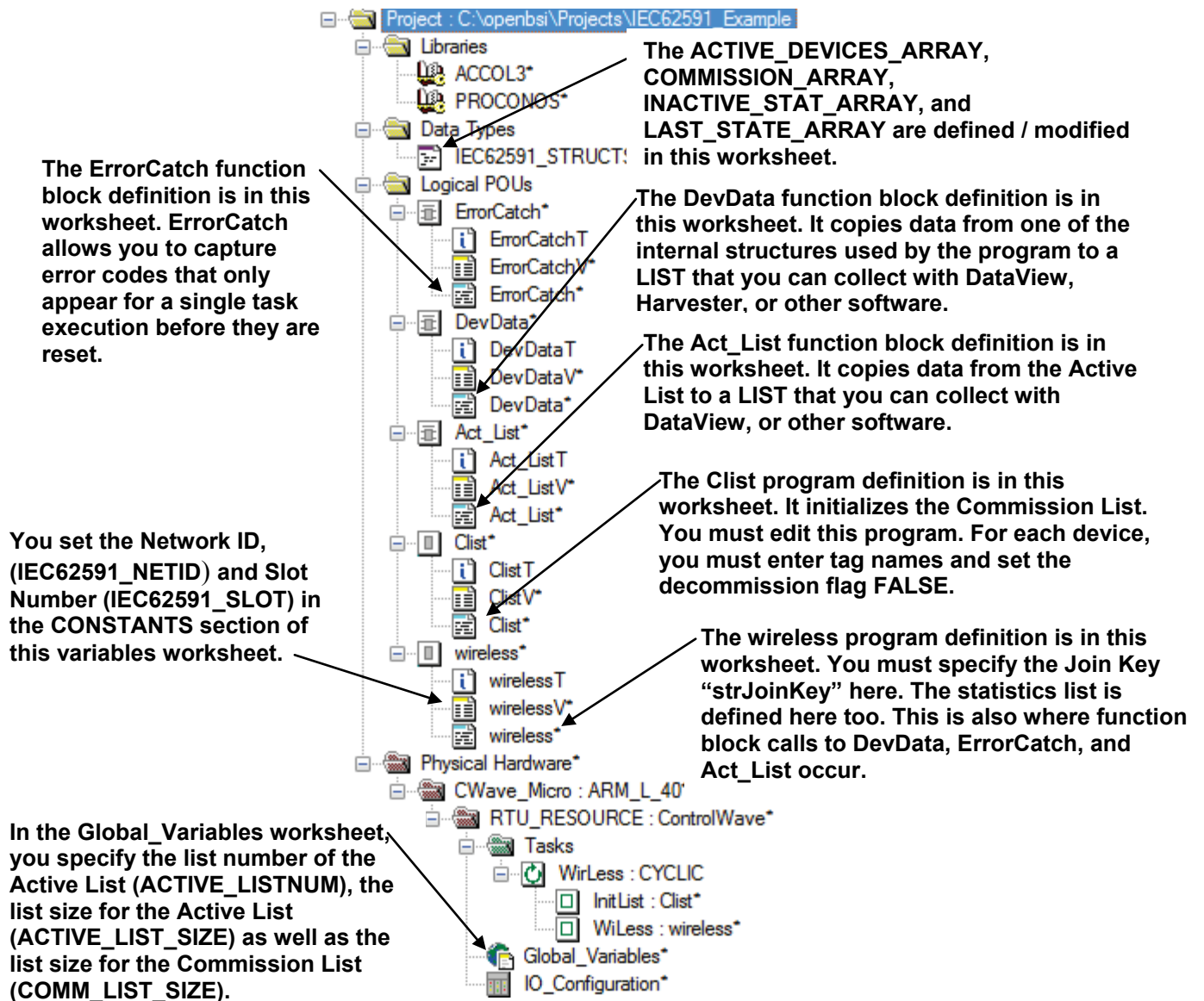

Figure 3-2. IEC 62591 Example – Project Tree

The next several sections outline how to modify the various worksheets in the project tree to meet the needs of your wireless network.



### 3.2.3 Modifying the IEC62591\_STRUCTS Datatypes Worksheet

The IEC62591\_STRUCTS datatypes worksheet defines the data types used by the program.

Double-click the IEC62591\_STRUCTS worksheet to open it.



#### Caution

**Do not modify the datatypes themselves or your IEC 62591 program will not function correctly. You should only define the sizes of specific arrays.**

You only modify the sizes of the array data types – these sizes vary depending upon the number of devices in the wireless network.

#### ACTIVE\_DEVICES\_ARRAY datatype

The ACTIVE\_DEVICES\_ARRAY datatype defines an array of active points that make up the Active List structure. The Active List maintains identification information on each wireless device discovered by the field link.

Specify the array size to be equal to the maximum number of wireless devices you expect to exist in the network. This number should match the value of the ACTIVE\_LIST\_SIZE variable in the Global\_Variables sheet.

```
TYPE
    ACTIVE_DEVICES_ARRAY : ARRAY [1..?] OF ACTIVE_POINT;
END_TYPE
```

#### COMMISSION\_ARRAY\_DISCRETE datatype -or- COMMISSION\_ARRAY datatype

Either or these datatypes defines an array of commission points that make up the Commission List structure. Which datatype you use depends on your application:

#### Notes:

- COMMISSION\_ARRAY\_DISCRETE, and COMMISSION\_POINT\_DISCRETE datatypes are used in the IEC62591\_DIO\_Example.zwt project. These structures are required for discrete I/O control. (5.70 or newer ControlWave Micro firmware)
- The COMMISSION\_ARRAY and COMMISSION\_POINT datatypes are used in the original IEC62591\_Example.zwt project. (5.60 or earlier ControlWave Micro firmware)

The Commission List holds a long tag name and a decommission flag for each device you intend to collect data from in your network. For any wireless device in the Commission List that has a matching tag name to a device in the Active List (meaning it was detected by the Smart Wireless Field Link) and its decommission flag is FALSE, the

Commission List also stores configuration information and actual process variable data.

Specify the commission array size to be equal to the maximum number of commissioned devices you expect to exist in the network. This number should match the value of the COM\_LIST\_SIZE variable in the Global\_Variables sheet.

```
TYPE  
    COMMISSION_ARRAY_DISCRETE : ARRAY [1..?] OF  
    COMMISSION_POINT_DISCRETE;  
END_TYPE
```

*Or*

```
TYPE  
    COMMISSION_ARRAY : ARRAY [1..?] OF COMMISSION_POINT;  
END_TYPE
```

where “?” is the maximum expected number of devices (including future expansion) for your network.

### **INACTIVE\_STAT\_ARRAY and LAST\_STATE\_ARRAY datatypes**

The INACTIVE\_STAT\_ARRAY and LAST\_STATE\_ARRAY are a pair of optional arrays that hold statistics about transmitter communication failures. Both these arrays (if used) should be sized to be equal to the maximum number of commissioned devices you expect to exist in the network. This number should match the value of the COM\_LIST\_SIZE variable in the Global\_Variables sheet.

```
TYPE  
    INACTIVE_STAT_ARRAY : ARRAY [1..?] OF INT;  
END_TYPE
```

```
TYPE  
    LAST_STATE_ARRAY : ARRAY [1..?] OF BOOL;  
END_TYPE
```

### **3.2.4 ErrorCatch Function Block (OPTIONAL)**

The ErrorCatch function block is called from within the Wireless worksheet. It maintains counts for different types of configuration errors and status conditions. There is no need to modify it. The ErrorCatch function block stores the error counts in the list specified by the ERROR\_CATCH\_LISTNUM variable in the Global\_Variables worksheet.

### **3.2.5 Modifying the DevData Function Block (OPTIONAL)**

The various structures in the IEC 62591 program are maintained internally; they cannot be collected by external utilities such as DataView. To support this sort of data collection, the IEC 62591 program does include a special function block (DevData) that copies specific device data from the Commission array to a LIST structure that can be collected by an external program such as DataView.

As written in the original IEC62591\_Example.zwt project, the DevData function block copies the following ten items from the COMMISSION\_ARRAY.

Item	Description
TagName	The unique long tag name assigned to the device (up to 32 characters)
bActive	A flag which indicates communication with the device
PV	Primary process variable from the device (1 <sup>st</sup> variable)
SV	Secondary process variable from the device (2 <sup>nd</sup> variable)
TV	Tertiary process variable from the device (3 <sup>rd</sup> variable)
QV	Quaternary process variable from the device (4 <sup>th</sup> variable)
Slot0Var, Slot1Var, Slot2Var, Slot3Var	Wireless devices include a series of variables called “slots” which hold process data for the device such as temperature, pressure, scaling factors, altitude, flow, and so on. You can use the SlotxVar items to specify up to four of these slots for collection from the device. Consult the documentation for the wireless device for information on which slots hold which variables.

If you decide that you don’t want all of these items in the LIST structure, or you want to choose one or more different items from the list, you can modify the DevData function block definition.

To do this, double-click the DevData worksheet to open it.

For example, if you decided that you didn’t want the Slot3Var, and instead you wanted the serial number of the device you would do the following:

Change the ianyElement10 entry in the LIST structure to reference SerialNum instead of slot3Var. (To see the exact names of the different items you can choose for entries in the LIST structure, click on the IEC62591\_STRUCTS worksheet and review the COMMISSION\_POINT\_DISCRETE or COMMISSION\_POINT structure definitions.)

```
LIST010_1(iiListNumber:=    inputListNum,
  ianyElement1:=          TagName,
  ianyElement2:=          bActive,
  ianyElement3:=          PV,
  ianyElement4:=          SV,
  ianyElement5:=          TV,
  ianyElement6:=          QV,
  ianyElement7:=          slot0Var,
  ianyElement8:=          slot1Var,
  ianyElement9:=          slot2Var,
  ianyElement10:=         SerialNum);
listStatus:=LIST010_1.odiStatus;
```

Now change the DEMUX function call for the tenth item to reference the serial number parameter of the COMMISSION\_POINT structure instead of the iorSlot3 parameter:

```
DEMUX_10(ianyInput := commissionList[inputDevNum].odiSerialNumber,
  iiSelect := 10,
  iiOutlist := inputListNum);
demuxStat := DEMUX_10.odiStatus;
```

Now, instead of the slot3var value, the device serial number is copied.

Another possible modification you could make, if you wanted to copy more than ten items, would be to use a larger size LIST definition, say LIST30 or LIST100. Remember that if you do this, you must define the destination list to be the same type.

You may also choose to replace these LIST function blocks with the lists defined using ControlWave Designer's Variable Extension Wizard and its resulting \_LIST.INI file.

### 3.2.6 Modifying the ACT\_LIST Function Block (OPTIONAL)

The Active List is a list maintained by the IEC62591 function block of all wireless devices detected by the Smart Wireless Field Link. The purpose of the ACT\_LIST function block is to copy the contents of the Active List to another LIST that can be collected by external software such as DataView.

---

**Note:** In the IEC62591\_DIO\_Example.zwt project, the ACT\_LIST function block is called ActiveList.

---

The only thing you might modify for this is the LIST function block that is part of the ACT\_LIST function block. By default, it uses a LIST020 function block which can have up to 20 elements – this allows a maximum of ten devices (defined by two elements for the tag name and device ID) in the active list. You can change this if you need to.

To do this, double-click the Act\_List worksheet to open it.

```
LIST020_1(      iiListNumber := inputListNum,
                ianyElement1 := Tag_1,
                ianyElement2 := DevId_1,
                ianyElement3 := Tag_2,
                ianyElement4 := DevId_2,
                ianyElement5 := Tag_3,
                ianyElement6 := DevId_3,
                ianyElement7 := Tag_4,
                ianyElement8 := DevId_4,
                ianyElement9 := Tag_5,
                ianyElement10 := DevId_5,
                ianyElement11 := Tag_6,
                ianyElement12 := DevId_6,
                ianyElement13 := Tag_7,
                ianyElement14 := DevId_7,
                ianyElement15 := Tag_8,
                ianyElement16 := DevId_8,
                ianyElement17 := Tag_9,
                ianyElement18 := DevId_9,
                ianyElement19 := Tag_10,
                ianyElement20 := DevId_10);
listStatus := LIST020_1.odiStatus;
```

Suppose, for example, that you needed to allow up to 50 devices in the active list?

ControlWave Designer supports LIST010, LIST020, LIST030, LIST050, and LIST100 function blocks. The easiest way to accommodate 50 devices is to replace the LIST020 function block with

a single LIST100 function block. In the code, below, we don't show devices 11 through 45 for space reasons:

```
LIST100_1(      iiListNumber := inputListNum,
                ianyElement1 := Tag_1,
                ianyElement2 := DevId_1,
                ianyElement3 := Tag_2,
                ianyElement4 := DevId_2,
                ianyElement5 := Tag_3,
                ianyElement6 := DevId_3,
                ianyElement7 := Tag_4,
                ianyElement8 := DevId_4,
                ianyElement9 := Tag_5,
                ianyElement10 := DevId_5,
                ianyElement11 := Tag_6,
                ianyElement12 := DevId_6,
                ianyElement13 := Tag_7,
                ianyElement14 := DevId_7,
                ianyElement15 := Tag_8,
                ianyElement16 := DevId_8,
                ianyElement17 := Tag_9,
                ianyElement18 := DevId_9,
                ianyElement19 := Tag_10,
                ianyElement20 := DevId_10
                :
                :
                ianyElement91 := Tag_46,
                ianyElement92 := DevId_46,
                ianyElement93 := Tag_47,
                ianyElement94 := DevId_47,
                ianyElement95 := Tag_48,
                ianyElement96 := DevId_48,
                ianyElement97 := Tag_49,
                ianyElement98 := DevId_49,
                ianyElement99 := Tag_50,
                ianyElement100 := DevId_50);
listStatus := LIST100_1.odiStatus;
```

If you need to support the maximum number of devices – 100 – you can do this by chaining together two LIST100 function blocks. To do this, you just use the same iiListNumber parameter for each; that connects the two to allow for a 200 element list.

### 3.2.7 Configuring the Commission List

When the Smart Wireless Field Link detects a wireless device that can be included in the network, it adds information about that device to the Active List. Process data from the device is only collected if it has a matching tag name in the Commission List, and if its decommission flag is FALSE – only then will its data be collected.

---

#### Notes:

- The Commission List structure in the IEC62591\_DIO\_Example.zwt project uses the COMMISSION\_ARRAY\_DISCRETE datatype, the the CommisList POU worksheet, and the CommissionListDiscrete array. (Use with ControlWave Micro firmware 5.70 or newer)
  - The Commission List structure in the IEC62591\_Example.zwt project uses the COMMISSION\_ARRAY datatype, the Clist POU worksheet, and the CommissionList array. (Use with ControlWave Micro firmware 5.60 or earlier)
-

You must create an entry in the Commission List that includes the long tag name for the device, and decommission flag (set to FALSE) for each and every device you want the IEC 62591 module to access.

To do this, double-click the CommisList (or Clist) worksheet to open it, then add or modify Commission List definitions to include a valid long tag name for each iostrTagName and specify FALSE for the ibDecommission flag for each device you want to commission. Specify TRUE for the ibDecommission flag only if you don't want to commission the device – for example, if it's not ready to be added to your system yet.

In the code below, devices DEV\_0001, DEV\_0002, DEV\_0003 and DEV\_0004 all have their ibDecommission flag set to FALSE, so they all can be commissioned and have process variable data collected over the network; DEV\_0005 has a decommission flag set to TRUE, so it cannot be commissioned, and its process data won't be collected unless that decommission flag is changed to FALSE.

```
IF (bInitCommList = TRUE) THEN
    bInitCommList := FALSE;

    commissionList[1].iostrTagName := 'DEV_0001';    (* Tagname in wireless transmitter. *)
    commissionList[1].ibDecommission := FALSE; (* Commission the device when found. *)

    commissionList[2].iostrTagName := 'DEV_0002';
    commissionList[2].ibDecommission := FALSE;

    commissionList[3].iostrTagName := 'DEV_0003';
    commissionList[3].ibDecommission := FALSE;
c
    commissionList[4].iostrTagName := 'DEV_0004';
    commissionList[4].ibDecommission := FALSE;

    commissionList[5].iostrTagName := 'DEV_0005';
    commissionList[5].ibDecommission := TRUE; (* Device is commissioned only after
                                                * this is changed to FALSE. *)

END_IF;
```

There are other parameters in the Commission List that populate automatically when the program sees a match between the long tag names in the Commission List, and the long tag names in the Active List – the iostrTagName and ibDecommission flag are the only portions you create or modify.

If, for some reason, you want to temporarily prevent data collection from a device in your wireless network, you can just set its decommission flag to TRUE.

### 3.2.8 Specifying the Join Key

All wireless devices in your wireless network share the same Join Key. You must also specify the same Join Key in your ControlWave project. You specify the Join Key in the Wireless worksheet.

Double-click on the Wireless worksheet and specify the Join Key using the strJoinKey variable.

```
strJoinKey := '12345678-00000000-00000000-00000000';
```

### 3.2.9 Specifying the Network ID and Slot Number

The wireless network of devices detected by the Smart Wireless Field Link has a Network ID.

You must specify the Network ID in the IEC62591\_NETID variable in the WirelessV worksheet of your ControlWave project.

In the same worksheet you use the IEC62591\_SLOT variable to specify the slot number of the ControlWave Micro controller that holds the IEC 62591 module. The IEC 62591 module can reside in any open I/O slot (slot 3 or higher) except for the last slot in the chassis.

Double-click on the WirelessV worksheet and specify the Network ID and slot number.

Specify the  
Network ID here.

Specify the slot that  
holds the IEC 62591  
module here.

Name	Type	Usage	Description	Address	Init	Retain	PDD	OF
<b>Globals</b>								
activeList	ACTIVE_DEVICE...	VAR_EXTE...						
commissionList	COMMISSION_A...	VAR_EXTE...						
COMM_LIST_SIZE	INT	VAR_EXTE...	MAX # elements in Commission List Array					
SWFL_STATISTICS_LISTNUM	INT	VAR_EXTE...						
ACTIVE_LISTNUM	INT	VAR_EXTE...						
ERROR_CATCH_LISTNUM	INT	VAR_EXTE...						
<b>Constants</b>								
IEC62591_NETID	UINT	VAR		2012				
IEC62591_SLOT	INT	VAR		1				
STATUS_BOOT_MODE	DINT	VAR		51003				
STATUS_CONFIG_MODE	DINT	VAR		51004				
STATUS_NO_ERROR	DINT	VAR		0				
<b>Statistics List</b>								
LIST020_1	LIST020	VAR						
swflBytesXmtd	UDINT	VAR	IEC62591 Wireless Interface Statistic					
swflBytesRcvd	UDINT	VAR	IEC62591 Wireless Interface Statistic					

Figure 3-3. Editing the WirelessV Worksheet

### 3.2.10 Configuring the Statistics List (OPTIONAL)

The optional Statistics List maintains information on the health of IEC 62591 communications for debugging purposes.

#### Notes:

- In the IEC62591\_DIO\_Example.zwt project, the Statistics list is defined in the StatsList worksheet.
- In the IEC62591\_Example.zwt project, the Statistics list is defined in the Wireless worksheet.

```
LIST020_1(iiListNumber:= SWFL_STATISTICS_LISTNUM,
ianyElement1:= swflBytesXmtd, (* IEC62591 Interface # bytes transmitted *)
ianyElement2:= swflBytesRcvd, (* IEC62591 Interface # bytes received *)
ianyElement3:= swflBytesDiscarded, (* IEC62591 Interface # bytes discarded *)
ianyElement4:= swflMsgsXmtd, (* IEC62591 Interface # messages transmitted *)
ianyElement5:= swflMsgsRcvd, (* IEC62591 Interface # messages received *)
ianyElement6:= swflNacksXmtd, (* IEC62591 Interface # NAKs transmitted *)
ianyElement7:= swflNacksRcvd, (* IEC62591 Interface # NAKs received *)
ianyElement8:= swflMsgRetriesRcvd, (* IEC62591 Interface # of message retries *)
ianyElement9:= swflSessionInitRcvd, (* IEC62591 Interface # session Initializations received *)
ianyElement10:= swflSessionRestartXmtd, (* IEC62591 Interface # session restarts transmitted *)
ianyElement11:= swflSetTimeMsgsXmtd, (* IEC62591 Interface # Set Time messages transmitted *)
ianyElement12:= swflSetTimeMsgsRcvd, (* IEC62591 Interface # Set Time messages received *)
```

```
ianyElement13:= swflResetApmMsgsXmtd, (* IEC62591 Interface # reset APM messages transmitted *)
ianyElement14:= swflResetApmMsgsRcvd, (* IEC62591 Interface # reset APM transmitted *)
ianyElement15:= swflTunnelMsgsXmtd, (* IEC62591 Interface # Tunnel messages transmitted *)
ianyElement16:= swflTunnelMsgsRcvd, (* IEC62591 Interface # Tunnel messages received *)
ianyElement17:= swflOtherHARTMsgsXmtd, (* IEC62591 Interface # other HART messages transmitted *)
ianyElement18:= swflOtherHARTMsgsRcvd,(* IEC62591 Interface # other HART messages received *)
ianyElement19:= swflRadioMsgsXmtd, (* IEC62591 Interface # Radio messages transmitted *)
ianyElement20:= swflRadioMsgsRcvd); (* IEC62591 Interface # Radio messages received *)

diStatisticsListStatus := LIST020_1.odiStatus;
```

The number of the Statistics List is set in the Global\_Variables worksheet and using the SWFL\_STATISTICS\_LISTNUM variable.

### 3.2.11 Generating Alarms Based on IEC62591 Function Block Status (OPTIONAL)

The IEC 62591 function block includes an **odiStatus** parameter which reports error and status codes for the IEC 62591 wireless interface. Descriptions of what the codes mean are located in the ControlWave Designer online help. You may choose to implement control logic to generate an alarm for certain odiStatus values.

For example, beginning with 1.01 IEC 62591 module firmware, odiStatus codes in the range -51120 to -51129 indicate the IEC 62591 Wireless Interface Module had to re-start and cannot provide live data updates until the re-start process is complete. You could add the code below to your ControlWave project to implement an alarm for that range of values:

```
(* Execute IEC62591 Function Block Instance.*)
IEC62591_1 (...);

(* Save the FB processing status. *)
IEC62591Status := IEC62591_1.odiStatus;

(* Set/Reset the alarm condition. *)
bXMTRFrozen := (IEC62591Status <= DINT#-51120) AND
(IEC62591Status >= DINT#-51129);

(* Execute the ALARM FB when variable is TRUE/ON *)
ALARM_LOGICAL_ON_1
( :
iaAlarmVar:=bXMTRFrozen,
:
);
```

### 3.2.12 Additional Programming Notes

The IEC 62591 example program includes two required program type POU's. One called "InitList" initializes the Commission List. The other called "WiLess" uses the Wireless worksheet definitions and includes the actual IEC62591 function block.



Both these program POUs reside within a CYCLIC task called “WirLess.”

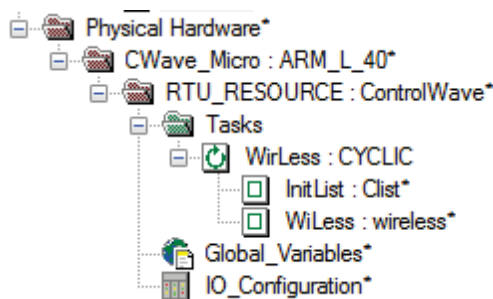

Figure 3-4. CYCLIC Task Running Wireless Program

---

**Note:** The “Wirless” task in the example program executes once per second to ensure processing of data from the wireless network. Do **not** change the task **Interval** setting from 1000 ms (1 second).

---

Once programming is complete, compile and build the ControlWave project and download it into the ControlWave Micro.

### 3.3 Commissioning Wireless Devices

---

Once you download the completed ControlWave project with the configured IEC 62591 program, it begins to execute within the ControlWave Micro and commissioning begins automatically.

---

**Note:** The Smart Wireless Field Link only detects those wireless devices that you have already individually configured with a unique long tag name, a common Network ID, and common Join Key. You perform this configuration separately using Field Tools’ AMS Device Configurator and a HART modem (or using an Emerson 375/475 Field Communicator). For information on configuring these devices using the AMS Device Configurator, see the *Emerson Process Management Field Tools Quick Start Guide* (part D301703X412).

---

The Smart Wireless Field Link detects any configured wireless devices and reports them to the IEC 62591 module.

The executing program adds these devices to the Active List, and checks for each device to see whether a matching device tag exists in the Commission List. Each device that has a matching tag along with an `ibDecommission` flag set to `FALSE` automatically becomes an active commissioned device in the network.

### 3.3.1 Active Advertising

In addition to the normal mode for detecting wireless devices, the system supports **active advertising**. In active advertising, the IEC 62591 module sends messages to the wireless network to keep radios active for a longer period of time to facilitate quicker detection of new (or replaced) wireless devices. Because leaving radios on consumes power, active advertising is only used under certain conditions:

- When the IEC 62591 module is first powered on, or is restarted after being powered off, it automatically remains in active advertising mode for a period of time to detect wireless devices.
- Whenever a new device is added to the network, active advertising is activated for a period of time in case additional devices are also added.
- Whenever a device leaves the network (becomes unreachable) active advertising is activated for a period of time to allow communications to be re-established.
- Beginning with ControlWave firmware version 5.70, the application programmer can force active advertising using the **ioaiMode** parameter in the IEC62591 function block. See the ACCOL3 online help in ControlWave Designer for details.

### 3.4 Decommissioning or Replacing Wireless Devices

---

If you want to temporarily remove a wireless device from the network, modify the ControlWave project to edit the Commission List and set the `ibDecommission` flag for that device to `TRUE`, then compile and download the revised project.

If you want to permanently remove a wireless device from the network, modify the ControlWave project to remove the device from the Commission List, then compile and download the revised project.

If you only want to replace a device, for example, because it failed and you want to put an identical device in the same location, there is no need to decommission the device; simply use the Field Tools' AMS Device Configurator or a hand held configuration device to specify the same long tag name, join key, and network ID in the replacement device, then install the new device normally, and it will join the network in place of the failed device.

### 3.5 WirelessHART Data Access and Statistics

---

The IEC 62591 Wireless Interface collects both *WirelessHART* data and statistics.

#### 3.5.1 WirelessHART Data Access

The IEC62591 function block is pre-configured to return the Universal and Common HART parameters including;

- Long Tag
- User Defined Message
- User Defined Descriptor
- Extended Device Type
- Device ID
- Manufacturer ID
- Device Serial Number
- Adapter Type – THUM’s Expanded Device Type
- Adapter ID – THUM’s Device ID
- PV, SV, TV and QV Variable Units
- Slot 0, 1, 2 and 3 Variable Units
- PV, SV, TV and QV Variable Value
- Slot 0, 1, 2 and 3 Variable Value
- Primary Variable Loop Current
- Device Status
- Battery Life (you may want to generate an alarm when this falls below a certain threshold; see *Section 3.2.11* for information on generating alarms.)
- PV Loop current
- Burst Rate

The following parameters require the discrete control version of the application and associated structures:

- Number of discrete channels
- Set class, Live Class, Set Point, and Live Value for each of up to four (4) discrete channels
- Failsafe mode (hold last value or use failsafe value)
- Failsafe value for PV, SV, TV, and QV
- PV validity flags – such as NAN (Not a Number)

---

**Notes:**

- The Commission List structure holds these items. You use the DEV\_DATA function block to access the parameters you need. See *Section 3.2.5* for more information.
  - The application you create must handle the PV validity flags. For example, the IEC 62591 module reports the flag but does not set the PVs to NAN. It is up to the application to choose whether to force a NAN value, use the failsafe value, or use the last reported good value.
  - Usage of the primary value (PV), secondary value (SV), tertiary value (TV) and quaternary value (QV) vary depending on the type of wireless device. For some devices, the primary value might be battery voltage, whereas for a different device it might be the loop current.
-

### 3.5.2 *Wireless*HART Communication Statistics

Detailed communication statistics are accumulated for the wireless network and optionally stored in the Statistics List (see *Section 3.2.10*). Transmit and receive data is accumulated for byte, message, session, tunnel, radio and other HART messages.

## 3.6 Upgrading Firmware in the IEC 62591 Wireless Interface Module

---

If a new version of firmware is released for the IEC 62591 module, either to support new features or correct problems, you can install it in the field through the USB port.

To do this, you must know the name of the variable associated with the **ioaiMode** parameter of the IEC62591 function block.

1. Create a folder named **upgrade** in the root of a USB memory stick.
2. Copy the firmware file to the upgrade folder.
3. Insert the USB memory stick into the USB port of the IEC 62591 Wireless Interface Module.
4. Using DataView or through ControlWave Designer in online operation, change the value of the **ioaiMode** parameter to **2** to start the firmware download.
5. Monitor the **odiStatus** parameter on the IEC62591 function block. While the download progresses, status code **51005** is reported. When the download completes the success code of **51006** appears momentarily; then **0** appears which means the firmware upgrade is complete. The upgrade takes approximately five minutes.

## Chapter 4 – Troubleshooting

### In This Chapter

4.1	Troubleshooting Guidelines .....	4-1
4.2	Common Troubleshooting Techniques.....	4-2
4.2.1	Identify which Components of the System Are Working .....	4-2
4.2.2	Basic Items to Check for Hardware.....	4-3
4.2.3	Checking Error/Status Codes in the Standard IEC 62591 Application .....	4-3
4.3	Troubleshooting Checklist .....	4-7
4.4	Best Practices .....	4-8
4.5	Data Updates .....	4-9

This chapter includes some general troubleshooting guidelines, as well as tips on certain common problems and how to overcome them.

### 4.1 Troubleshooting Guidelines

Before you begin to trouble-shoot the interface, you should observe the following guidelines.

- **Don't overlook the obvious.** With all the activity involved in setting up a wireless network, it is easy to accidentally unplug an antenna or disconnect power from a device. Check those things *first*. (For a list of common problems, see the *Troubleshooting Checklist* at the end of this chapter.)
- **If something worked previously, but now has stopped working, did you change something?** If, for example, you change the application running in the ControlWave Micro and re-download it, and now it stopped working, it's possible that the change you made to the application might have caused a problem.
- **Adopt a systematic approach.** Don't try to solve the problem by changing several different things at once. Change one thing, see if it causes an improvement, then make notes about what you did, *then* you can try to make other changes. If you haphazardly begin swapping hardware modules, re-routing cables, and changing software parameters, you may end up in worse shape than when you started, or you may end up masking symptoms of an underlying problem.
- **Try to isolate the problem.** If, for example, you can communicate with *some* wireless devices but not others, then concentrate on what's different with the non-functional wireless devices, or their configuration parameters. If you can't communicate with any wireless devices, you might not have correctly configured network parameters in the application, or there may be a problem at the field link.

- **Use the hardware and software diagnostic tools provided with the product.** The ControlWave Micro process automation controller includes status LEDs on both the CPU and PSSM modules; see the ControlWave Micro instruction manual for explanations of what these status LEDs mean. The IEC 62591 wireless application running in the ControlWave Micro includes error codes which you can check; often these will identify configuration problems for you.
- **Collect and save as much relevant information as you can.** If possible, make notes concerning what steps you took leading up to the initial occurrence of the problem. Save printouts, screen captures, error codes, and so on so you can refer to them if you have to call for technical assistance.

The remainder of this section includes:

- Trouble-Shooting Techniques
- Trouble-Shooting Checklist

---

## 4.2 Common Troubleshooting Techniques

### 4.2.1 Identify which Components of the System Are Working

The wireless interface has several different pieces of hardware and software. A failure in any one of them can cause problems, so you should consider all the different pieces to try to identify the source of your problem.

For hardware you have:

- ControlWave Micro controller with IEC 62591 module installed in a slot
- Smart Wireless Field Link
- PC or laptop connected the ControlWave Micro
- Cable between IEC 62591 module and Smart Wireless Field Link
- One or more wireless devices in the wireless network
- Field Communicator (optional)

For software you have:

- The IEC 62591 application (ControlWave project) running in the ControlWave Micro
- ControlWave Designer software, and Field Tools AMS Device Configurator running in the PC or laptop
- IEC 62591 protocol software running in the Smart Wireless Field Link and in all of the wireless devices

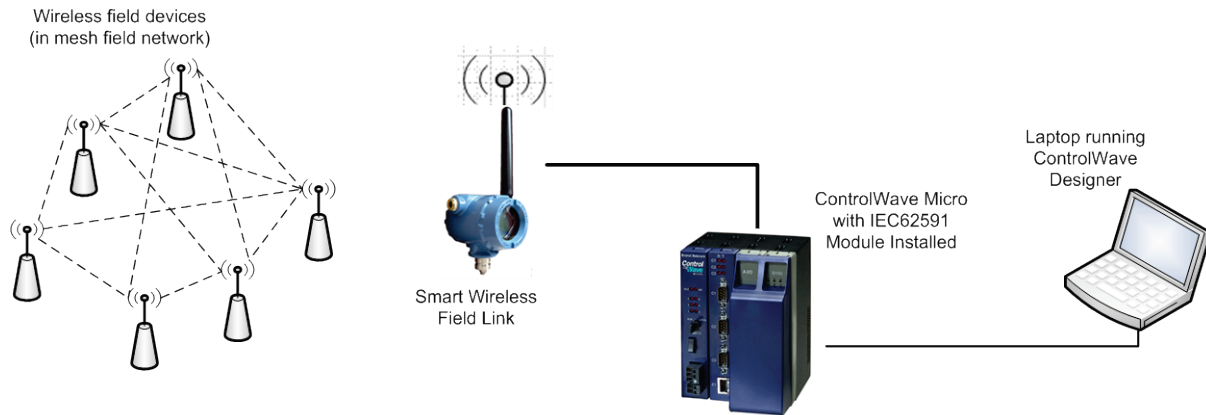

Figure 4-1. Wireless Interface

## 4.2.2 Basic Items to Check for Hardware

- Ensure power is connected.
- Check that all modules are properly seated in slots.
- Ensure cable connections are good between the field link and controller, and between the PC/laptop and the controller.
- Check status LEDs on the controller. For information on what the LEDs mean, see the ControlWave Micro instruction manual (part D301392X012).
- Check for indications on the Smart Wireless Field Link. See its accompanying documentation for details.

## 4.2.3 Checking Error/Status Codes in the Standard IEC 62591 Application

**Note:** This procedure assumes that:

- You have ControlWave Designer installed on the PC/laptop.
- You are running the standard IEC 62591 application (ControlWave project) in the ControlWave Micro and have an identical copy of the project on the PC/laptop.
- You have a successful communication connection between the PC/laptop and the ControlWave Micro.

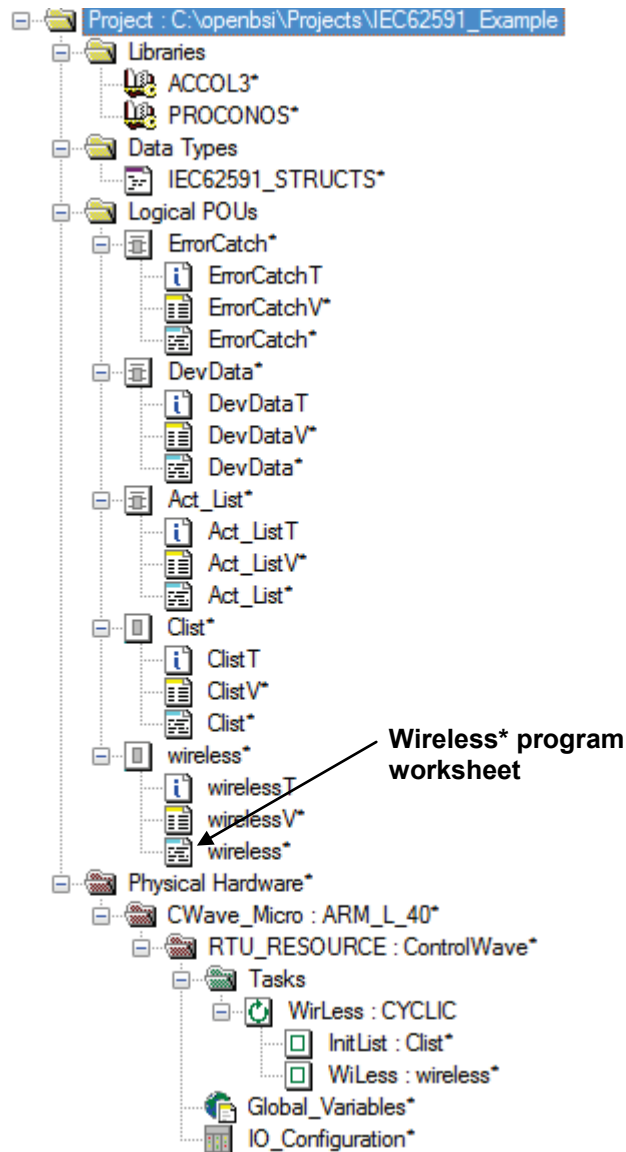

Figure 4-2. IEC 62591 Example – Project Tree

1. Start ControlWave Designer (if it's not already running).
2. Click **File >Open Project/Unzip Project**
3. If not already there, navigate to the OpenBSI/Projects area and open the file IEC62591\_Example.mwt. When you open the project, you can see the project tree. (See *Figure 4-2*.)
4. Click **Online > Debug**.
5. Double-click on the wireless\* program worksheet.
6. Scroll down through the worksheet until you see the IEC 62591 function block. (You'll notice that in Debug Mode, a column of live values sits to the left of the program statements; these are the actual parameter values in the program as it executes in the ControlWave Micro.)



48 49 50 51 52 53 54 55 56 57 58 59 60 61 62 63 64	<p style="text-align: center;"><b>Column of live values</b></p> <p style="text-align: center;">↓</p> <p>odiStatus value of IEC62591 function block →</p>	<pre> 16#601154B4 IEC62591_1 (ioabInit      := bInitIEC62591, 16#601154B6      ioaiMode       := mode, 16#601141AC      iaActiveList    := activeList, 16#601144F4      iaCommissioned := commissionList, 16#601154B8      iaJoinKey       := strJoinKey,                 2012      iuiNetworkID   := uiNetworkID,                 1        iiSlot        := IEC62591Slot,                 5        iiList        := SWFL_STATISTICS_LISTNUM); -51012 IEC62591Status := IEC62591_1.odiStatus; 0 IEC62591DevCount := IEC62591_1.oideviceCount; IEC62591RevString := IEC62591_1.ostrFWRevision;  99 ErrorCatch_1 (inputListNum := ERROR_CATCH_LISTNUM, -51012      in_Status := IEC62591Status); </pre>	<p style="text-align: center;"><b>odiStatus parameter</b></p> <p style="text-align: center;">↓</p>
--	--	---	--

Figure 4-3. Wireless Program Worksheet

7. Find the odiStatus parameter for the IEC62591 function block. (Figure 4-3 shows this; in this particular example, the parameter has a variable name of IEC62591Status; if your programmer used a different name, then the name will be different but the parameter is the same).
8. Look at the value in the live value column for the odiStatus parameter; for the example in Figure 4-3 the value is “-51012.” Because it’s negative, that means it’s an error, and we need to find out what “-51012” means.
9. To find out what the error means, go to the project tree and right-click on the ACCOL3 library icon, and choose **Help on ‘ACCOL3’ library**.

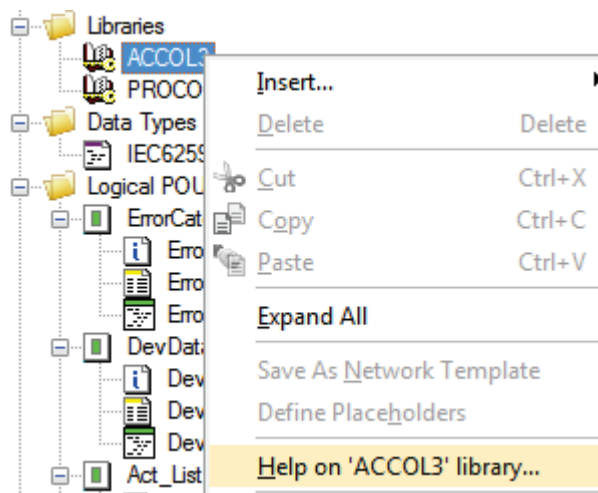

Figure 4-4. Calling Up the ACCOL3 Help Files

10. Go to the ACCOL3 Function Blocks help, and scroll down (or expand the tree item) until you get to the IEC62591 help topic, then click on it.

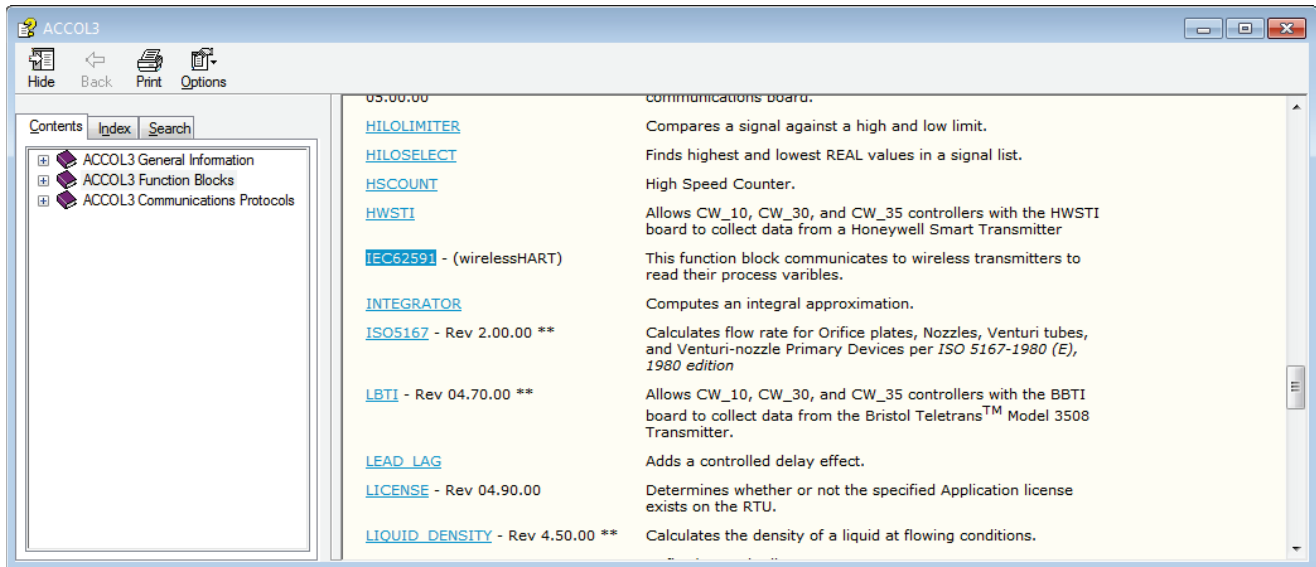

Figure 4-5. Selecting the IEC62591 Help Topic

11. Scroll down in the IEC62591 help topic until you find the **odiStatus** description; click on the **status code** link to bring up a list of status codes. (You may want to print out this list for reference as you're troubleshooting.)

**Outputs:**

<b>odiStatus</b>	Default:	NONE
	Format:	DINT
	Input/Output:	Output

This parameter is a [status code](#) which is updated after the execution of the function block.

Figure 4-6. Status Code Link

12. Find the code you're looking for (in this example "-51012") and you'll see what the error means. For "-51012" the error says:

**-51012 Card type mismatch - slot MUST have a IEC62591 Wireless Interface Module.**

Figure 4-7. Example of Error Message

That means the IEC 62591 function block does not detect an IEC 62591 Wireless Interface module in the specified slot. This happens if you

specify an incorrect slot number in the application, or the module is missing entirely.

Alternatively, if you know the complete error number, you can use the Search tab to type in the error code, then click **List Topics**, and double-click on the results to see the error.

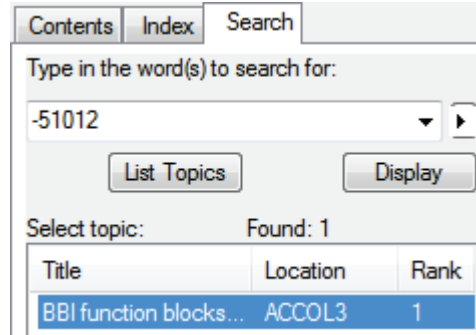

Figure 4-8. Search Tab

**Note:** You can follow this same basic procedure to look up any odiStatus parameter value. In addition, if you specified a list for storing error totals in the application, you can view statistics on what types of errors are occurring. To do this, you should double-click on the ErrorCatch worksheet. Alternatively, you could use DataView to view the ErrorCatch list.

### 4.3 Troubleshooting Checklist

- Does the IEC 62591 Wireless Interface support your wireless device(s)? Check the product data sheet (available on our [website](#)) to verify that your devices have been tested with the interface.
- Did you assign a unique Long Tag Name to each wireless device and specify the exact same long tag names in the IEC 62591 application running in the ControlWave Micro? If not, use Field Tools' AMS Device Configurator software or a 375/475 Field Communicator to set the long tag name in the device, and use ControlWave Designer to set the long tag names within the IEC 62591 application running in the ControlWave Micro.
- Did you assign a Network ID which must be the same in each and every wireless device in this network, and must also match the Network ID defined in the IEC 62591 application running in the ControlWave Micro? If not, use Field Tools' AMS Device Configurator software or a 375/475 Field Communicator to set the Network ID in the devices, and use ControlWave Designer to set the Network ID within the IEC 62591 application running in the ControlWave Micro.
- Did you assign a Join Key which must be the same in each and every wireless device in this network, and must also match the Join Key defined in the IEC 62591 application running in the

ControlWave Micro? If not, use Field Tools' AMS Device Configurator software or a 375/475 Field Communicator to set the Join Key in the devices, and use ControlWave Designer to set the Join Key within the IEC 62591 application running in the ControlWave Micro.

- Is the IEC62591 module in the ControlWave Micro in the proper slot as specified in the IEC 62591 application running in the ControlWave Micro? If not, place the module in the proper slot or change the slot number defined in the IEC 62591 application to match the slot in which the module resides.
- Are you using the proper datatypes for the Commission List and Commission Point?
- Is the decommission flag for each device set to FALSE in the IEC 62591 application running in the ControlWave Micro?
- Does each device in the network have power? If not, connect power.
- Are cables connected properly between the Smart Wireless Field Link and the ControlWave Micro?
- Are any status LEDs lit on the ControlWave Micro PSSM module? If so, consult the ControlWave Micro instruction manual for more information.
- Did you check for error/status codes in the IEC 62591 application? If not, follow the instructions in *Section 4.2.3*.

## 4.4 Best Practices

---

While the IEC62591 function block makes device data available to the application and SCADA it does not take independent action unless the application is designed to do so. The best recommended practice to ensure the end device is operating optimally is either configure the SCADA system to monitor the status of the field devices or develop application solutions using the RTU's alarm, event, or Report By Exception features. Information needed to make these decisions is available in following elements of the commission list entry and the IEC62591 function block status:

- **odiStatus:** IEC6259 function block status output parameter
- **obActive:** Device is actively communicating
- **ousDeviceStatus:** Device status bits
- **ouiBatteryDays:** Status of the device's lithium battery
- **ousDevCommishStatus:** Device commissioning status
- **iousiFailSafeMode:** Device failsafe mode
- **obyteNaNFlag:** Whether slot or process variable(s) are Not-A-Number
- **obyte'xx'Status:** Four process variable status bits
- **obyteLive'n'Status:** Four live value status bits

## 4.5 Data Updates

---

If you notice that data updates for process variables are slow, this can occur if the IEC 62591 device cannot process a data request fast enough. If this happens it generates a delayed response message, and the RTU re-requests the data.

To see if you are receiving delayed response messages, look for a 9 (Delayed Response Received) status on the **ousDevCommishStatus** parameter of the Commission List entry.

*[This page is intentionally left blank.]*

# Glossary

---

**Note:** This is a generalized glossary of terms. Not all the terms may necessarily correspond to the particular device or software described in this manual.

---

## #

---

**375/475** Model numbers for the Field Communicator, a portable configurator which lets you set certain parameters in a wired or wireless device such as a transmitter.

## A

**Active Advertising** A mode in which the IEC 62591 module sends messages to the wireless network to keep radios active for a longer period of time to facilitate quicker detection of new (or replaced) wireless devices. Because leaving radios on consumes power, active advertising is only used under certain conditions.

**Active List** A list maintained in the ControlWave RTU of detected wireless devices which can potentially be commissioned.

**AGA** American Gas Association. A professional organization that oversees the AGA3 (orifice), AGA5 (heating value), AGA7 (turbine), AGA8 (compressibility), and AGA11 (ultrasonic) gas flow calculation standards. See <http://www.aga.org>.

**AWG** American Wire Gauge.

**AI** Analog Input.

**AO** Analog Output.

**Analog** Analog data is represented by a continuous variable, such as an electrical current signal.

**AP** Absolute Pressure.

**API** American Petroleum Institute. See <http://www.api.org>.

**ASCII** American (National) Standard Code for Information Interchange.

## B

---

**BPS** Bits Per Second, associated with baud rate.

**BTU** British Thermal Unit, a measure of heat energy.

## C

---

**C1D1** Class 1, Division 1 hazardous area

**C1D2** Class 1, Division 2 hazardous area

**CMOS** Complementary Metal Oxide Semiconductor, a type of microprocessor used in a controller.

**COM** Communications port on a personal computer (PC) or a controller (RTU).

**Commission List** A list of wireless devices which belong to a wireless network and have their decommission flag set to FALSE. This means that process variable data should be collected from these devices.

**ControlWave** A brand name for a family of controllers (RTUs) and flow computers available from Emerson.

**ControlWave Designer** A software configuration tool that lets you create programming logic for the ControlWave controller or flow computer.

<b>CPU</b>	Central Processing Unit.
<b>CRC</b>	Cyclical Redundancy Check error checking.
<b>CSA</b>	Canadian Standards Association. See <a href="http://www.csa.ca">http://www.csa.ca</a> .
<b>CTS</b>	Clear to Send modem communications signal.

---

**D**

---

<b>DCE</b>	Data Communication Equipment.
<b>Deadband</b>	A value that is an inactive zone above the low limits and below the high limits. The purpose of the deadband is to prevent a value (such as an alarm) from being set and cleared continuously when the input value is oscillating around the specified limit.
<b>DI</b>	Discrete Input.
<b>Discrete</b>	Input or output that is non-continuous, typically representing two levels (such as on/off).
<b>DO</b>	Discrete Output.
<b>Download</b>	The process of sending data, a file, or a program from a PC to an RTU.
<b>DP</b>	Differential Pressure.

---

**D (continued)**

---

<b>DSR</b>	Data Set Ready modem communications signal.
<b>DTE</b>	Data Terminal Equipment.
<b>DTR</b>	Data Terminal Ready modem communications signal.
<b>Duty Cycle</b>	Proportion of time during a cycle that a device is activated. A short duty cycle conserves power for I/O channels, radios, and so on.

---

**E**

---

<b>EEPROM</b>	Electrically Erasable Programmable Read-Only Memory, a form of permanent memory.
<b>EFM</b>	Electronic Flow Metering or Measurement.
<b>EMI</b>	Electro-Magnetic Interference.
<b>ESD</b>	Electro-Static Discharge.

---

**F**

---

<b>FCC</b>	Federal Communications Commission. See <a href="http://www.fcc.gov">http://www.fcc.gov</a> .
<b>Field Communicator</b>	A portable configurator which lets you set certain parameters in a wired or wireless device such as a transmitter.
<b>Firmware</b>	Internal software that is factory-loaded into the ControlWave RTU.
<b>Flash</b>	A type of memory that can be electrically re-programmed. It is a form of permanent memory (requires no backup power). Also called Flash memory.
<b>FM</b>	Factory Mutual.
<b>FOUNDATION<sup>™</sup> Fieldbus</b>	An open architecture for information integration, managed by the Fieldbus Foundation ( <a href="http://www.fieldbus.org">www.fieldbus.org</a> ).
<b>FPV</b>	Compressibility Factor.
<b>Function Block</b>	A software structure in ControlWave Designer that performs some calculation or other function. Function blocks can include multiple inputs and multiple outputs. Sometimes abbreviated as FB.

---

**F (continued)**

---

<b>FSK</b>	Frequency Shift Keypad.
------------	-------------------------



**G**

---

<b>GHz</b>	Gigahertz, 10 <sup>9</sup> cycles per second
<b>GND</b>	Electrical ground, such as used by the RTU's power supply.
<b>GP</b>	Gauge Pressure.

**H**

---

<b>H1</b>	A Foundation Fieldbus protocol operating at 31.25 kbit/s that interconnects field devices (such as sensors or I/O devices).
<b>HART</b>	Highway Addressable Remote Transducer.
<b>HSE Protocol</b>	High Speed Ethernet protocol; a communications protocol operating at 100 Mbit/s used to integrate high-speed controllers (or servers) connected via Ethernet.
<b>Hw</b>	Differential pressure.
<b>Hz</b>	Hertz.

**I**

---

<b>IC</b>	Integrated Circuit. Also, Industry Canada (more recently known as Measurement Canada), an organization that grants approvals on certain RTUs/flow computers.
<b>ID</b>	Identification.
<b>IEC</b>	Industrial Electrical Code or International Electrotechnical Commission. See <a href="http://www.iec.ch">http://www.iec.ch</a> .
<b>IEC 62591</b>	is a global IEC-approved standard (also referred to as "WirelessHART or WiHART" that specifies an interoperable self-organizing mesh technology in which field devices form wireless networks that dynamically mitigate obstacles in the process environment. This architecture creates a cost-effective automation alternative that does not require wiring and other supporting infrastructure.
<b>IEC 62591 Module</b>	A hardware module that resides in a ControlWave Micro controller's I/O slot to support communication with a Smart Wireless Field Link and WiHART network.
<b>IEEE</b>	Institute of Electrical and Electronic Engineers. A professional organization that, in conjunction with the International Standards Organization (ISO), establishes and maintains the Open System Interconnection (OSI) reference model and an international standard for the organization of local area networks (LANs). Refer to <a href="http://www.ieee.org">http://www.ieee.org</a> .
<b>I/O</b>	Input/Output.
<b>I/O Module</b>	Module that plugs into an I/O slot in an RTU or I/O expansion rack.
<b>ISO</b>	International Standards Organization. See <a href="http://www.iso.ch">http://www.iso.ch</a> .

**J**

---

<b>Join Key</b>	A password that allows a device to access its defined network. During transmitter setup, you assign the same Join Key to every device in the network, typically using a Field Communicator or PC-based AMS Device Manager software. When you configure your ControlWave project using ControlWave Designer, you will need to know the Join Key for this network.
-----------------	--

**K**

---

<b>KB</b>	Kilobytes.
<b>kHz</b>	KiloHertz.

**L**

---

<b>LCD</b>	Liquid Crystal Display.
<b>LED</b>	Light-Emitting Diode. A status light.
<b>Long Tag</b>	A name (up to 32 characters) for a device in the wireless network. Each device in the wireless network must have a unique long tag, different from all other devices in the network. Typically you specify the long tag using a Field Communicator or PC-based AMS Device Manager software.

**M**

---

<b>m</b>	Meter.
<b>mA</b>	Milliamp(s); one thousandth of an ampere.
<b>MAC Address</b>	Media Access Control Address; a hardware address that uniquely identifies each node of a network.
<b>Modbus</b>	A popular device communications protocol developed by Gould-Modicon.
<b>mm</b>	Millimeter.
<b>MMBTU</b>	Million British Thermal Units.
<b>msec</b>	Millisecond, or 0.001 second.
<b>MVS</b>	Multi-Variable Sensor. A device that provides differential pressure, static pressure, and temperature inputs to a flow computer..
<b>mV</b>	Millivolts, or 0.001 volt.
<b>mW</b>	Milliwatts, or 0.001 watt.

**N**

---

<b>NaN</b>	Not-a-Number. This refers to a value which cannot be expressed as a number, such as a division by zero error condition.
<b>NEC</b>	National Electrical Code.
<b>Network ID</b>	An identifying number for the wireless network. During transmitter setup, you assign the same Network ID to every device in the network, typically using a Field Communicator or PC-based AMS Device Manager software. When you configure your ControlWave project using ControlWave Designer, you will need to know the Network ID for this network.
<b>NEMA</b>	National Electrical Manufacturer's Association. See <a href="http://www.nema.org">http://www.nema.org</a> .
<b>Node</b>	A basic element of a network. Typically this would be an RTU or flow computer.

**O**

---

<b>OE</b>	Abbreviation for OpenEnterprise – a brand name for our SCADA software package.
<b>Off-line</b>	Accomplished while the target device is not connected (by a communications link).
<b>Ohms</b>	Units of electrical resistance.
<b>On-line</b>	Accomplished while connected (by a communications link) to the target device.
<b>Orifice meter</b>	A meter that records the flow rate of gas through a pipeline. The flow rate is calculated from the pressure differential created by the fluid passing through an orifice of a particular size and other parameters.

**P, Q**

---

<b>Parameter</b>	A property of a point that typically can be configured or set. For example, the Point Tag ID is a parameter of an Analog Input point. Parameters are normally edited by using configuration software running on a PC.
<b>PC</b>	Personal Computer.
<b>Pf</b>	Flowing pressure.
<b>P/DP</b>	Pressure/Differential Pressure.
<b>PI</b>	Pulse Input.
<b>PID</b>	Proportional, Integral, and Derivative control feedback action.
<b>PLC</b>	Programmable Logic Controller.
<b>Point</b>	Software-oriented term for an I/O channel or some other function.
<b>Protocol</b>	A set of standards that enables communication or file transfers between two computers. Protocol parameters include baud rate, parity, data bits, stop bit, and the type of duplex.
<b>PSTN</b>	Public Switched Telephone Network.
<b>Pulse</b>	Transient variation of a signal whose value is normally constant.
<b>PV</b>	Process Variable or Process Value.

**R**

---

<b>RAM</b>	Random Access Memory. RAM is used to store history, data, most user programs, and additional configuration data.
<b>RBE</b>	Report-By-Exception. This is a method of data collection where data is only reported when a value change occurs.
<b>RFI</b>	Radio Frequency Interference.
<b>ROM</b>	Read-only memory. Typically used to store firmware.
<b>RTC</b>	Real-Time Clock.
<b>RTD</b>	Resistance Temperature Detector.
<b>RTS</b>	Ready to Send modem communications signal.
<b>RTU</b>	Remote Terminal Unit. This is commonly used to refer to a process controller, such as a ControlWave or ControlWave Micro.
<b>RS-232</b>	Serial Communications Protocol using three or more signal lines, intended for short distances. Also referred to as the EIA-232 standard.
<b>RS-485</b>	Serial Communications Protocol requiring only two signal lines. Intended for longer distances up to 4000 feet. Also referred to as the EIA-485 standard.
<b>RX or RXD</b>	Received Data communications signal.

**S**

---

<b>SCADA</b>	Supervisory control and data acquisition; referring to a computer system that monitors and controls oil and gas pipeline systems. OpenEnterprise is a SCADA software package.
<b>Script</b>	An uncompiled text file (such as keystrokes for a macro) that a program interprets in order to perform certain functions. Typically, the end user can easily create or edit scripts to customize the software.
<b>Smart Wireless Field Link</b>	Provides the communication connection between the ControlWave or ROC host device and the wireless network.
<b>SP</b>	Setpoint, or Static Pressure.

**SRAM** Static Random Access Memory. Stores data as long as power is applied; typically backed up by a lithium battery.

**T**

---

**TCP/IP** Transmission Control Protocol/Internet Protocol.

**Tf** Flowing temperature.

**TX or TXD** Transmitted Data communications signal.

**Turbine meter** A device used to measure flow rate and other parameters.

**U**

---

**Upload** Send data, a file, or a program from the RTU to a PC or other host.

**USB** Universal Serial Bus, a serial bus standard used to connect devices.

**V**

---

**v** Volts.

**W-Z**

---

**WiHART** Wireless HART

*[This page is intentionally left blank.]*

For customer service and technical support, visit [www.emersonprocess.com/remote/support](http://www.emersonprocess.com/remote/support)

Headquarters:

**Emerson Process Management**  
Remote Automation Solutions  
6005 Rogerdale Road  
Houston, TX 77072 U.S.A.  
T +1 281 879 2699 | F +1 281 988 4445  
[www.EmersonProcess.com/Remote](http://www.EmersonProcess.com/Remote)

Europe:

**Emerson Process Management**  
Remote Automation Solutions  
Unit 8, Waterfront Business Park  
Dudley Road, Brierley Hill  
Dudley UK DY5 1LX  
T +44 1384 487200 | F +44 1384 487258  
[www.EmersonProcess.com/Remote](http://www.EmersonProcess.com/Remote)

North American/Latin America:

**Emerson Process Management**  
Remote Automation Solutions  
6005 Rogerdale Road  
Houston TX USA 77072  
T +1 281 879 2699 | F +1 281 988 4445  
[www.EmersonProcess.com/Remote](http://www.EmersonProcess.com/Remote)

Middle East/Africa:

**Emerson Process Management**  
Remote Automation Solutions  
Emerson FZE  
P.O. Box 17033  
Jebel Ali Free Zone – South 2  
Dubai U.A.E.  
T +971 4 8118100 | F +971 4 8865465  
[www.EmersonProcess.com/Remote](http://www.EmersonProcess.com/Remote)

Asia-Pacific:

**Emerson Process Management**  
Remote Automation Solutions  
1 Pandan Crescent  
Singapore 128461  
T +65 6777 8211 | F +65 6777 0947  
[www.EmersonProcess.com/Remote](http://www.EmersonProcess.com/Remote)

©2015 Remote Automation Solutions, a business unit of Emerson Process Management. All rights reserved.

Remote Automation Solutions, a business unit of Emerson Process Management, shall not be liable for technical or editorial errors in this manual or omissions from this manual. REMOTE AUTOMATION SOLUTIONS MAKES NO WARRANTIES, EXPRESSED OR IMPLIED, INCLUDING THE IMPLIED WARRANTIES OF MERCHANTABILITY AND FITNESS FOR A PARTICULAR PURPOSE WITH RESPECT TO THIS MANUAL AND, IN NO EVENT SHALL REMOTE AUTOMATION SOLUTIONS BE LIABLE FOR ANY INCIDENTAL, PUNITIVE, SPECIAL OR CONSEQUENTIAL DAMAGES INCLUDING, BUT NOT LIMITED TO, LOSS OF PRODUCTION, LOSS OF PROFITS, LOSS OF REVENUE OR USE AND COSTS INCURRED INCLUDING WITHOUT LIMITATION FOR CAPITAL, FUEL AND POWER, AND CLAIMS OF THIRD PARTIES.

Emerson Process Management Ltd, Remote Automation Solutions (UK), is a wholly owned subsidiary of Emerson Electric Co. doing business as Remote Automation Solutions, a business unit of Emerson Process Management. FloBoss, ROCLINK, ControlWave, Helicoid, and OpenEnterprise are trademarks of Remote Automation Solutions. AMS, PlantWeb, and the PlantWeb logo are marks owned by one of the companies in the Emerson Process Management business unit of Emerson Electric Co. Emerson Process Management, Emerson and the Emerson logo are trademarks and service marks of the Emerson Electric Co. All other marks are property of their respective owners.

The contents of this publication are presented for informational purposes only. While every effort has been made to ensure informational accuracy, they are not to be construed as warranties or guarantees, express or implied, regarding the products or services described herein or their use or applicability. Remote Automation Solutions reserves the right to modify or improve the designs or specifications of such products at any time without notice. All sales are governed by Remote Automation Solutions' terms and conditions which are available upon request. Remote Automation Solutions does not assume responsibility for the selection, use or maintenance of any product. Responsibility for proper selection, use and maintenance of any Remote Automation Solutions product remains solely with the purchaser and end-user.