

AWT210

2-wire conductivity, pH/ORP pION transmitter



Measurement made easy

—
AWT210
2-wire transmitter

Introduction

This Commissioning Instruction provides basic installation, operation and software information for the AWT210 2-wire transmitter. The transmitter is fully compatible with ABB's range of pH and redox (ORP) electrodes and with ABB's range of 2-electrode, 4-electrode and toroidal sensors. The transmitter has automatic temperature sensor recognition for Pt100, Pt1000 and 3k Balco RTDs in either 2-lead or 3-lead configurations.

The AWT210 transmitter is available with a traditional 4 to 20 mA output or with advanced digital communications utilizing FOUNDATION Fieldbus (FF), PROFIBUS PA (PA) or HART. The transmitter is equipped with an LCD display used to show the current process data and 4 keys beneath the display enable the transmitter to be configured locally.

For more information

Further publications for the AWT210 transmitter are available for free download from: www.abb.com/measurement

or by scanning this code:



Links and reference numbers for the transmitter publications are also shown below:

	Search for or click on:
AWT210 transmitter – Data Sheet	DS/AWT210-EN
AWT210 transmitter – Operating Instruction	OI/AWT210-EN
AWT210 transmitter – HART Communications Supplement	COM/AWT210/HART-EN
AWT210 transmitter – HART FDS Communications Supplement	COM/AWT210/HART/FDS-EN
AWT210 transmitter – PROFIBUS Communications Supplement	COM/AWT210/PROFIBUS-EN
AWT210 transmitter – FIELDBUS Communications Supplement	COM/AWT210/FIELDBUS-EN

Contents

1	Health & Safety	4	5	Mechanical installation	11
	Document symbols	4		Sensor installation	11
	Safety precautions	4		Transmitter installation	11
	Potential safety hazards	4		Transmitter dimensions	11
	AWT210 transmitter – electrical	4		Fitting communication modules	11
	Safety standards	4		Location	11
	Product symbols	4		Optional accessories	11
	Product recycling and disposal (Europe only)	5		Wall mounting	12
	End-of-life battery disposal	5		Panel mounting (optional)	13
	Information on ROHS Directive 2011/65/EU (RoHS II)	5		Pipe mounting (optional)	14
2	Cyber security	5	6	Electrical installation	15
3	Overview	6		Terminal connections	15
	Name plate/certification label	6		pH/ORP/pION sensor module connections	16
	Transmitters without hazardous area approval	6		Standard sensors without diagnostic functions	16
	Transmitters with FM/CSA approval and ATEX IECEx	6		Standard sensors with diagnostic functions	16
				BNC adaptor option	16
4	Hazardous area considerations	7		Conductivity sensor module connections	17
	Approvals	7		2-electrode sensors	17
	CE Mark	7		4-electrode sensors	17
	Ignition protection	7		Toroidal sensors	17
	Ground	7		Communication module connections	18
	Interconnection	7		HART module	18
	Power supply for intrinsically safe applications	7		FOUNDATION Fieldbus module	18
	Configuration	7		Profibus PA module	18
	Service and repair	7		Ground connection	18
	Risk of electrostatic discharge	7		Gland entries	18
	Hazardous area relevant information	8	7	Operation	19
	Factory Mutual (FM)	8		Operator Page – normal conditions	19
	Canadian Standards Authority (CSA)	9		Operator Page – alarm conditions	19
	ATEX/IECEX	10		Operator menu	20
	Specific conditions of use	10		Signals View	20
			8	Diagnostic alarms	21

Sales



Service



Software



9	Password security and Access Level	23
	Access Level	23
	Write protect switch	23
	Setting passwords	23
	Password recovery	23
	Advanced level password recovery	23
	Service level password recovery	23
10	Menu overview	24
	pH menus	24
	2-electrode conductivity menus	25
	4-electrode conductivity menus	26
	Toroidal conductivity menus	27
11	Calibration	28
	pH sensor calibration	28
	Auto Buffer Cal	28
	1-point manual calibration	29
	2-point manual calibration	29
	2-electrode conductivity sensor calibration	30
	4-electrode conductivity sensor calibration	31
	Toroidal conductivity sensor calibration	31
	PV Zero calibration	31
	PV Span calibration	32
12	Specification	33
13	Spare parts	36
	Communications module assemblies	36
	Sensor module assemblies	36
	Main case assemblies	36
	Gland packs	36
	Glands (packs of 2)	36
	Mounting kits	36
	Panel-mount kit	36
	Pipe-mount kit	36
	Wall-mount kit	36
	Weathershield kit	36
	Weathershield kit	36
	Weathershield and pipe-mount kit	36

1 Health & Safety

Document symbols

Symbols that appear in this document are explained below:

DANGER

The signal word '**DANGER**' indicates an imminent danger. Failure to observe this information will result in death or severe injury.

WARNING

The signal word '**WARNING**' indicates an imminent danger. Failure to observe this information may result in death or severe injury.

CAUTION

The signal word '**CAUTION**' indicates an imminent danger. Failure to observe this information may result in minor or moderate injury.

NOTICE

The signal word '**NOTICE**' indicates potential material damage.

Note

'**Note**' indicates useful or important information about the product.

Safety precautions

Be sure to read, understand and follow the instructions contained within this manual before and during use of the equipment. Failure to do so could result in bodily harm or damage to the equipment.

WARNING

Serious damage to health/risk to life

The AWT210 transmitter is a certified product suitable for use in hazardous area locations. Before using this product refer to the product labeling for details of hazardous area certification. Maintenance and installation must be carried out only by the manufacturer, authorized agents or persons conversant with the construction standards for hazardous area certified equipment.

Potential safety hazards

AWT210 transmitter – electrical

Damage to the equipment.

WARNING

Bodily injury.

To ensure safe use when operating this equipment, the following points must be observed:

- Normal safety precautions must be taken to avoid the possibility of an accident occurring when operating in conditions of high pressure and/or temperature.

Safety advice concerning the use of the equipment described in this manual or any relevant Material Safety Data Sheets (where applicable) can be obtained from the Company, together with servicing and spares information.

Safety standards

This product has been designed to satisfy the requirements of IEC61010-1:2010 3rd edition 'Safety Requirements for Electrical Equipment for Measurement, Control and Laboratory Use' and complies with US NEC 500, NIST and OSHA.

Product symbols

Symbols that may appear on this product are shown below:



Protective earth (ground) terminal.



Functional earth (ground) terminal.



This symbol, when noted on a product, indicates a potential hazard which could cause serious personal injury and/or death. The user should reference this instruction manual for operation and/or safety information.



This symbol, when noted on a product enclosure or barrier, indicates that a risk of electrical shock and/or electrocution exists and indicates that only individuals qualified to work with hazardous voltages should open the enclosure or remove the barrier.



Recycle separately from general waste under the WEEE directive.

Product recycling and disposal (Europe only)



ABB is committed to ensuring that the risk of any environmental damage or pollution caused by any of its products is minimized as far as possible. The European Waste Electrical and Electronic Equipment (WEEE) Directive that initially came into force on August 13 2005 aims to reduce the waste arising from electrical and electronic equipment; and improve the environmental performance of all those involved in the life cycle of electrical and electronic equipment. In conformity with European local and national regulations, electrical equipment marked with the above symbol may not be disposed of in European public disposal systems after 12 August 2005.

End-of-life battery disposal

The transmitter contains a small lithium battery (located on the processor/display board) that must be removed and disposed of responsibly in accordance with local environmental regulations.

Information on ROHS Directive 2011/65/EU (RoHS II)



ABB, Industrial Automation, Measurement & Analytics, UK, fully supports the objectives of the ROHS II directive. All in-scope products placed on the market by IAMA UK on and following the 22nd of July 2017 and without any specific exemption, will be compliant to the ROHS II directive, 2011/65/EU.

2 Cyber security

This product is designed to be connected to and to communicate information and data via a digital communication interface. It is your sole responsibility to provide and continuously ensure a secure connection between the product and your network or any other network (as the case may be). You shall establish and maintain any appropriate measures (such as but not limited to the application of authentication measures etc.) to protect the product, the network, its system and the interface against any kind of security breaches, unauthorized access, interference, intrusion, leakage and/or theft of data or information.

ABB Ltd and its affiliates are not liable for damages and/or losses related to such security breaches, any unauthorized access, interference, intrusion, leakage and/or theft of data or information.

3 Overview

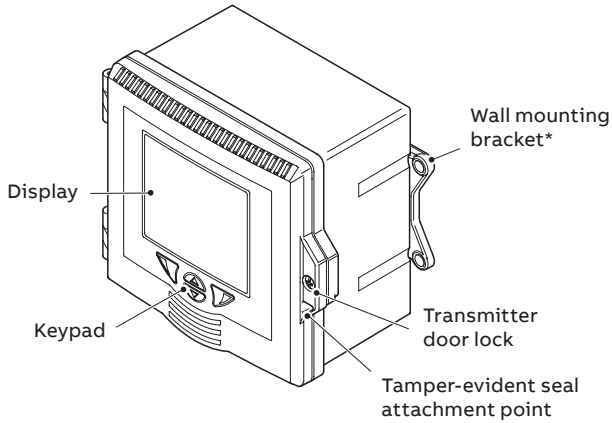

Name plate/certification label

The following name plates are examples only. The name plates attached to the transmitter may be different.

Transmitters without hazardous area approval

ABB ABB Ltd St Neots, Cambs, PE19 8EU, UK AWT210 2 Wire Transmitter AWT200050 Serial No.: 3K210000000000 Supply: HART 14-30VDC, 4-20mA FF/PA 9-24VDC, 15mA DATE OF MANUFACTURE: MM/YYYY		

Transmitters with FM/CSA approval and ATEX IECEx Aluminium enclosure

II 1 G Ex ia IIC T4 Ga -20 °C ≤ Ta ≤ +60 °C IP66 FM18ATEX0017X IECEx FME 18.0001X Installation drg AWT2100034		IS : Class I Div 1 ABCD T4, Class II Div 1 EFG T4 -25 °C ≤ Ta ≤ +60 °C Exia NI: Class 1 Div 2 Gps ABCD Class II Div 2 Gps FG Class III -25 °C ≤ Ta ≤ +60 °C FM18US0040X FM18CA0019X USA: AWT200030 & AWT200031 Canada: AWT200032 & AWT200033 WARNING: SUBSTITUTION OF COMPONENTS MAY IMPAIR INTRINSIC SAFETY.
<input type="checkbox"/> HART Transmitter: AWT210AxxxH1E5xxxxxx Ui = 30v Ii = 100mA Pi = 0.8W Ci = 0.56nF Li = 3.3mH		
<input type="checkbox"/> Fieldbus Transmitter: AWT210AxxxF1E5xxxxxx Entity Model: Ui = 24v Ii = 250mA Pi = 1.2W Ci = 1.1nF Li = 0mH FISCO Field Device: Ui = 17.5v Ii = 380mA Pi = 5.32W Ci = 1.1nF Li = 0mH		AVERTISSEMENT: LA SUBSTITUTION DE COMPOSANTS PEUT NUIRE A LA SECURITE INTRINSEQUE.
<input type="checkbox"/> Profibus Transmitter: AWT210AxxxP1E5xxxxxx Entity Model: Ui = 24v Ii = 250mA Pi = 1.2W Ci = 1.1nF Li = 0mH FISCO Field Device: Ui = 17.5v Ii = 360mA Pi = 2.52W Ci = 1.1nF Li = 0mH		

Transmitters with FM/CSA approval and ATEX IECEx Plastic enclosure

II 1 G Ex ia IIC T4 Ga -20 °C ≤ Ta ≤ +60 °C IP66 FM18ATEX0017X IECEx FME 18.0001X Installation drg AWT200034		IS : Class I Div 1 ABCD T4, Class II Div 1 EFG T4 -25 °C ≤ Ta ≤ +60 °C Exia FM18US0040X FM18CA0019X Installation drg: USA: AWT200030 Canada: AWT200032
<input type="checkbox"/> HART Transmitter: AWT210AxxxH1E5xxxxxx Ui = 30v Ii = 100mA Pi = 0.8W Ci = 0.56nF Li = 3.3mH		
<input type="checkbox"/> Fieldbus Transmitter: AWT210AxxxF1E5xxxxxx Entity Model: Ui = 24v Ii = 250mA Pi = 1.2W Ci = 1.1nF Li = 0 mH FISCO Field Device: Ui = 17.5v Ii = 380mA Pi = 5.32W Ci = 1.1nF Li = 0mH		WARNING: SUBSTITUTION OF COMPONENTS MAY IMPAIR INTRINSIC SAFETY.
<input type="checkbox"/> Profibus Transmitter: AWT210AxxxP1E5xxxxxx Entity Model: Ui = 24v Ii = 250mA Pi = 1.2W Ci = 1.1nF Li = 0mH FISCO Field Device: Ui = 17.5v Ii = 360mA Pi = 2.52W Ci = 1.1nF Li = 0mH		AVERTISSEMENT: LA SUBSTITUTION DE COMPOSANTS PEUT NUIRE A LA SECURITE INTRINSEQUE.

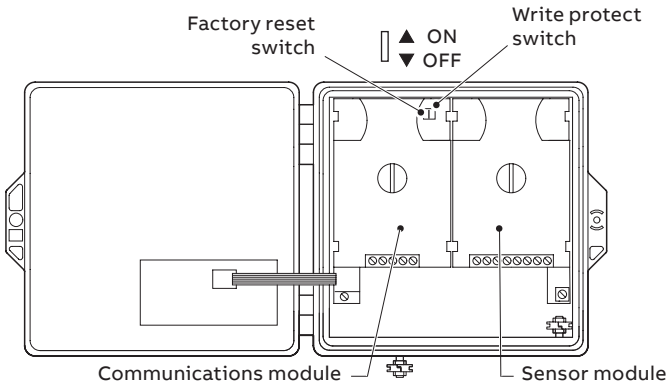

*Panel- and pipe-mount options are also available – see page 13

Figure 1 AWT210 transmitter – main components

NOTICE

After commissioning, the factory reset switch must be set to the **OFF** position. This will ensure the device does not lose configuration settings in the event of a power loss.

4 Hazardous area considerations

Special regulations must be observed in hazardous areas for the auxiliary power connection, signal inputs/outputs and ground connection.

DANGER

- All parts must be installed in accordance with manufacturer information and relevant standards and regulations.
- Startup and operation must be performed in accordance with ATEX User Directive 99/92/EC or BetrSichV (EN60079-14).

Approvals

CE Mark

The AWT210 transmitter meets all requirements for the CE mark in accordance with applicable EC Directives 2004/108/EC (EMC), 2006/95/EC (LVD) and 94/9/EC (ATEX).

Ignition protection

The AWT210 transmitter is available with FM, CSA and ATEX/IEC approval. Hazardous area relevant information is included later in this section.

Ground

If for functional reasons, the intrinsically safe circuit must be grounded by connecting it to an equipotential bonding system, it must be grounded at a single location only.

Interconnection

Special interconnections, dependent on the safety requirements, are required when the transmitter is used in hazardous areas. Proof of interconnection may be required during the installation if the transmitter is operated in an intrinsically safe circuit.

Power supply for intrinsically safe applications

The power supply SPS inputs must have corresponding input protection circuits available to eliminate spark hazards. An interconnection inspection must be performed. For proof of intrinsic safety, the electrical limit values must be used as the basis for the prototype test certificates of the transmitters, including the capacitance and inductance values of the wires. Proof of intrinsic safety is granted if the following conditions are fulfilled.

Output parameter of power supply/SPS input	Input parameter of AWT210 transmitter		
Max. output voltage	$U_o \leq$	U_i	Max. input voltage
Max. output current	$I_o \leq$	I_i	Max. input current
Max. output power	$P_o \leq$	P_i	Max. input power
Max. output inductance	$L_o \geq$	$L_i + L_c$	Internal inductance + inductance of cable
Max. output capacitance	$C_o \geq$	$C_i = C_c$	Internal capacitance + capacitance of cable

Configuration

AWT210 transmitters can be installed in hazardous areas in compliance with proof-of-interconnection and directly in a hazardous area using approved handheld HART/Fieldbus terminals (proof of interconnection may be required during the installation) as well as by coupling an ignition-proof modem to the circuit outside the hazardous area.

Service and repair

DANGER

This product has no live maintenance facility. The instrument must be de-energized before any maintenance is performed.

If the instrument is located in a hazardous area, other than the serviceable items listed on page 36, none of the instrument's components can be serviced by the user. Only personnel from ABB, its approved representative(s) or persons conversant with the construction standards for hazardous area certified equipment, is (are) authorized to attempt repairs to the system and only components formally approved by the manufacturer should be used. Any attempt at repairing the instrument in contravention of these principles could cause damage to the instrument and corporal injury to the person carrying out the repair. It renders the warranty null and void and could compromise the hazardous area certification, correct working of the instrument, electrical integrity and the CE compliance of the instrument.

If you have any problems with installation, starting or using the instrument please contact the company that sold it to you. If this is not possible, or if the results of this approach are not satisfactory, please contact the manufacturer's Customer Service.

Risk of electrostatic discharge

If the instrument is mounted in a hazardous area and the exterior of the instrument requires cleaning, care should be taken to minimize the risk of electrostatic discharge. Use a damp cloth or similar to clean all surfaces.

...4 Hazardous area considerations

Hazardous area relevant information

NOTICE

The hazardous area designation is displayed on the name plate/certification label – see page 6.

Factory Mutual (FM)

Intrinsic safety

Class I, Div 1, Group A,B,C,D T4
Class II/III, Div 1, Group E,F,G T4

Ingress protection classification

4X*/IP66

Ambient temperature range

-25 °C =< Ta =< 60 °C

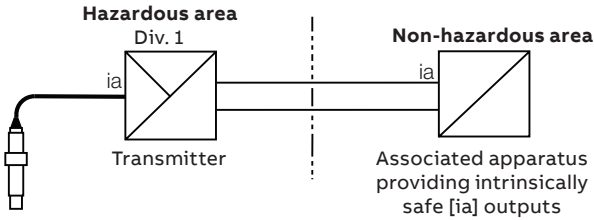

Figure 2 Intrinsic safety – FM

FM Intrinsic Safety control drawing

[Click here](#) to download the FM Intrinsic safety control drawing for AWT210 transmitter, or scan this code:



Input parameters of AWT210 transmitter: HART

Maximum voltage	Ui =	30 V
Maximum input current	li =	100 mA
Maximum power	Pi =	0.8 W
Internal inductance	Li =	3.3 mH
Internal capacitance	Ci =	0.56 nF

Input parameters of AWT210 transmitter: Fieldbus

	Entity model	FISCO Field Device
Maximum voltage	Ui = 24 V	17.5 V
Maximum input current	li = 250 mA	380 mA
Maximum power	Pi = 1.2 W	5.32 W
Internal inductance	Li = 0 mH	0 mH
Internal capacitance	Ci = 1.1 nF	1.1 nF

Input parameters of AWT210 transmitter: Profibus

	Entity model	FISCO Field Device
Maximum voltage	Ui = 24 V	17.5 V
Maximum input current	li = 250 mA	360 mA
Maximum power	Pi = 1.2 W	2.52 W
Internal inductance	Li = 0 mH	0 mH
Internal capacitance	Ci = 1.1 nF	1.1 nF

Output parameters of sensor: 4-electrode, 2-electrode, toroidal, pH

Maximum open-circuit voltage	Uo =	11.8 V
Maximum short-circuit current	Io =	11.8 mA
Maximum output power	Po =	36 mW
Maximum inductance	Lo =	1 H
Maximum capacitance	Co =	1.5 µF

Non-incendive

Class I, Div 2, Group A,B,C,D T4
Class II/III, Div 2, Group F,G T4

Ingress protection classification

4X*/IP66

Ambient temperature range

-25 °C =< Ta =< 60 °C

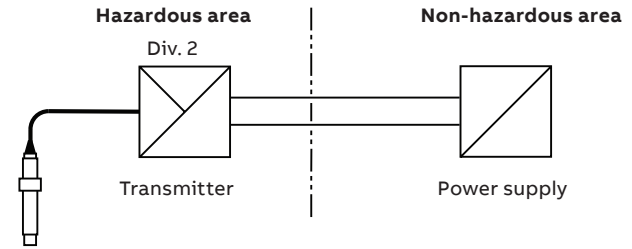

Figure 3 Non-incendive (using non-incendive field wiring) – FM

FM Non-incendive Safety control drawing

[Click here](#) to download the FM Non-incendive safety control drawing for AWT210 transmitter, or scan this code:



NOTICE

Parameters apply to entire system inclusive of cables.

Each specified electrical parameter must be applied individually and in combination. Do not exceed the maximum values when applying the electrical parameters individually or in combination.

*4X Hosedown self-assessed not approved by 3rd party.

NOTICE

Installation must be in accordance with the National Electrical Code (NFPA 70).

Canadian Standards Authority (CSA)

Intrinsic safety

Class I, Div 1, Group A,B,C,D T4

Class II/III, Div 1, Group E,F,G T4

Ingress protection classification

4X*/IP66

Ambient temperature range

-25 °C =< Ta =< 60 °C

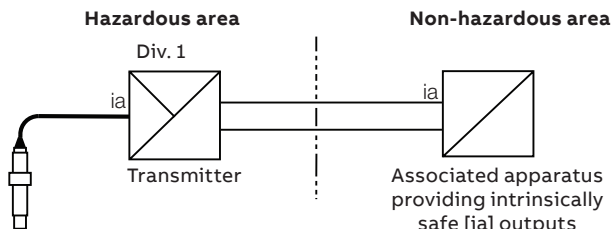

Figure 4 Intrinsic safety – CSA

CSA Intrinsic Safety control drawing

[Click here](#) to download the CSA Intrinsic safety control drawing for AWT210 transmitter, or scan this code:



Input parameters of AWT210 transmitter: HART	
Maximum voltage	Ui = 30 V
Maximum input current	Ii = 100 mA
Maximum power	Pi = 0.8 W
Internal inductance	Li = 3.3 mH
Internal capacitance	Ci = 0.56 nF

Input parameters of AWT210 transmitter: Fieldbus	Entity model	FISCO Field Device
Maximum voltage	Ui = 24 V	17.5 V
Maximum input current	Ii = 250 mA	380 mA
Maximum power	Pi = 1.2 W	5.32 W
Internal inductance	Li = 0 mH	0 mH
Internal capacitance	Ci = 1.1 nF	1.1 nF

Input parameters of AWT210 transmitter: Profibus	Entity model	FISCO Field Device
Maximum voltage	Ui = 24 V	17.5 V
Maximum input current	Ii = 250 mA	360 mA
Maximum power	Pi = 1.2 W	2.52 W
Internal inductance	Li = 0 mH	0 mH
Internal capacitance	Ci = 1.1 nF	1.1 nF

Output parameters of sensor: 4-electrode, 2-electrode, toroidal, pH	
Maximum open-circuit voltage	Uo = 11.8 V
Maximum short-circuit current	Io = 11.8 mA
Maximum output power	Po = 36 mW
Maximum inductance	Lo = 1 H
Maximum capacitance	Co = 1.5 µF

Non-incendive

Class I, Div 2, Group A,B,C,D T4

Class II/III, Div 2, Group F,G T4

Ingress protection classification

4X*/IP66

Ambient temperature range

-25 °C =< Ta =< 60 °C

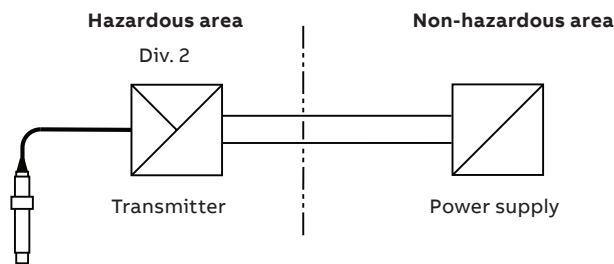

Figure 5 Non-incendive (using non-incendive field wiring) – CSA

CSA Non-incendive Safety control drawing

[Click here](#) to download the CSA Non-incendive safety control drawing for AWT210 transmitter, or scan this code:



NOTICE

Parameters apply to entire system inclusive of cables.

Each specified electrical parameter must be applied individually and in combination. Do not exceed the maximum values when applying the electrical parameters individually or in combination.

*4X Hosedown self-assessed not approved by 3rd party.

NOTICE

Installation must be in accordance with C22.1 Canadian Electrical Code, Part 1.

...4 Hazardous area considerations

...Hazardous area relevant information

ATEX/IECEX

Intrinsic safety

II 1G Ex ia IIC T4 Ga when used with appropriate barriers.

Ingress protection classification

IP66

Ambient temperature range

-20 °C =< Ta =< 60 °C

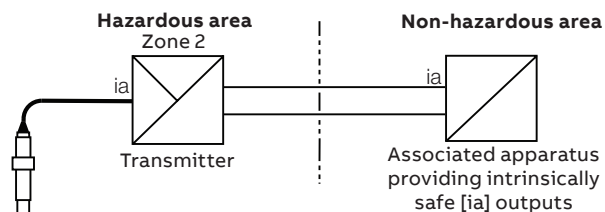

Figure 6 Intrinsic safety – ATEX/IEC

ATEX-IECEX Safety control drawing

[Click here](#) to download the ATEX-IECEX safety control drawing for AWT210 transmitter, or scan this code:



Input parameters of AWT210 transmitter: HART

Maximum voltage	Ui =	30 V
Maximum input current	li =	100 mA
Maximum power	Pi =	0.8 W
Internal inductance	Li =	3.3 mH
Internal capacitance	Ci =	0.56 nF

Input parameters of AWT210 transmitter: Fieldbus	Entity model	FISCO Field Device
Maximum voltage	Ui =	24 V 17.5 V
Maximum input current	li =	250 mA 380 mA
Maximum power	Pi =	1.2 W 5.32 W
Internal inductance	Li =	0 mH 0 mH
Internal capacitance	Ci =	1.1 nF 1.1 nF

Input parameters of AWT210 transmitter: Profibus	Entity model	FISCO Field Device
Maximum voltage	Ui =	24 V 17.5 V
Maximum input current	li =	250 mA 360 mA
Maximum power	Pi =	1.2 W 2.52 W
Internal inductance	Li =	0 mH 0 mH
Internal capacitance	Ci =	1.1 nF 1.1 nF

Output parameters of sensor: 4-electrode, 2-electrode, toroidal, pH

Maximum open-circuit voltage	Uo =	11.8 V
Maximum short-circuit current	Io =	11.8 mA
Maximum output power	Po =	36 mW
Maximum inductance	Lo =	1 H
Maximum capacitance	Co =	1.5 µF

NOTICE

Parameters apply to entire system inclusive of cables.

Each specified electrical parameter must be applied individually and in combination. Do not exceed the maximum values when applying the electrical parameters individually or in combination.

NOTICE

Installation must be in accordance with IEC 60079-14 and the wiring practices for the country of installation.

Specific conditions of use

- For the aluminium enclosure for EPL Ga –**
the AWT210 enclosure option (code position 8, option 2 – see Data Sheet [DS/AWT210-EN](#)) contains aluminium and is considered to present a potential risk of ignition by impact or friction. Care shall be taken into account during installation and use to prevent impact or friction.
- For the aluminium enclosure –**
for areas subject to explosive dust atmospheres the painted surface of the AWT210 may store electrostatic charge and become a source of ignition in applications with a low relative humidity <~30% relative humidity where the painted surface is relatively free of surface contamination such as dirt, dust, or oil. Guidance on protection against the risk of ignition due to electrostatic discharge can be found in IEC TS 60079-32-1. Cleaning of the painted surface shall only be done in accordance with the manufacturer's instructions (see page 7).
- For the Lexan enclosure –**
for areas subject to explosive gas atmospheres the Lexan enclosure AWT210 may store electrostatic charge and become a source of ignition in applications with a low relative humidity <~30% relative humidity where the Lexan is relatively free of surface contamination such as dirt, dust, or oil. Guidance on protection against the risk of ignition due to electrostatic discharge can be found in IEC TS 60079-32-1. Cleaning of the surface shall only be done in accordance with the manufacturer's instructions (see page 7).
- For aluminium and Lexan enclosures –**
the AWT210 shall not be used where UV light or radiation may impinge on the enclosure or the window of the enclosure.
- For Non-Incendive applications the sensor can be used **only** in non-flammable materials.

5 Mechanical installation

Sensor installation

Refer to the sensor's Operating Instruction for installation procedures.

Transmitter installation

Transmitter dimensions

Dimensions in mm (in)

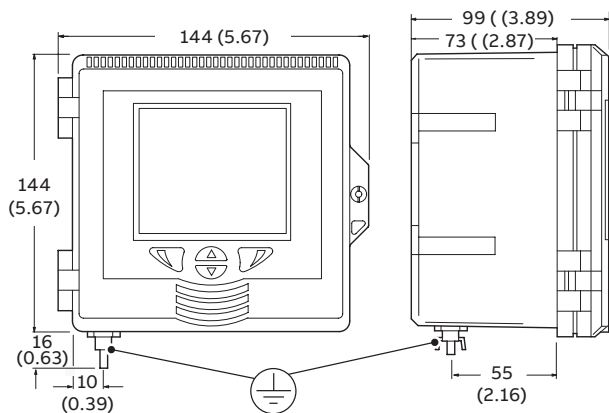

Figure 7 Transmitter dimensions

Fitting communication modules

Referring to Figure 8:

- 1 Ensure the locking spindle on both modules is in the UNLOCKED position.
- 2 Fit communication module (A) to baseboard (B) (the left, COMMUNICATION MODULE position).
- 3 Turn the locking spindle ¼ turn to the LOCKED position.
- 4 Fit sensor module (C) to baseboard (D) (the right, SENSOR MODULE position).
- 5 Turn the locking spindle ¼ turn to the LOCKED position.

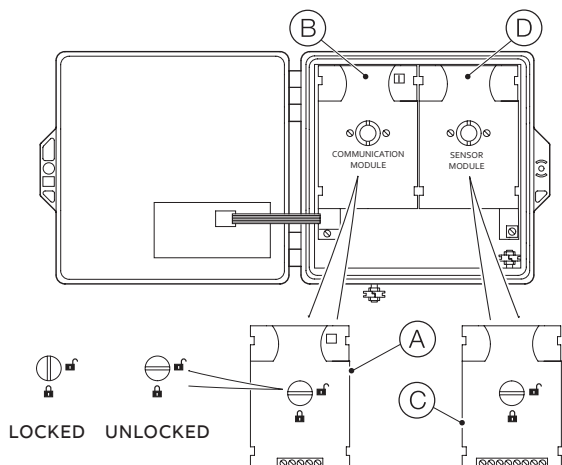

Figure 8 Fitting communication modules

Location

For general location requirements refer to Figure 9. Select a location away from strong electrical and magnetic fields. If this is not possible, particularly in applications where mobile communications equipment is expected to be used, screened cables within flexible, earthed metal conduit must be used.

Install in a clean, dry, well ventilated and vibration-free location providing easy access. Avoid rooms containing corrosive gases or vapors – for example, chlorination equipment or chlorine gas cylinders.

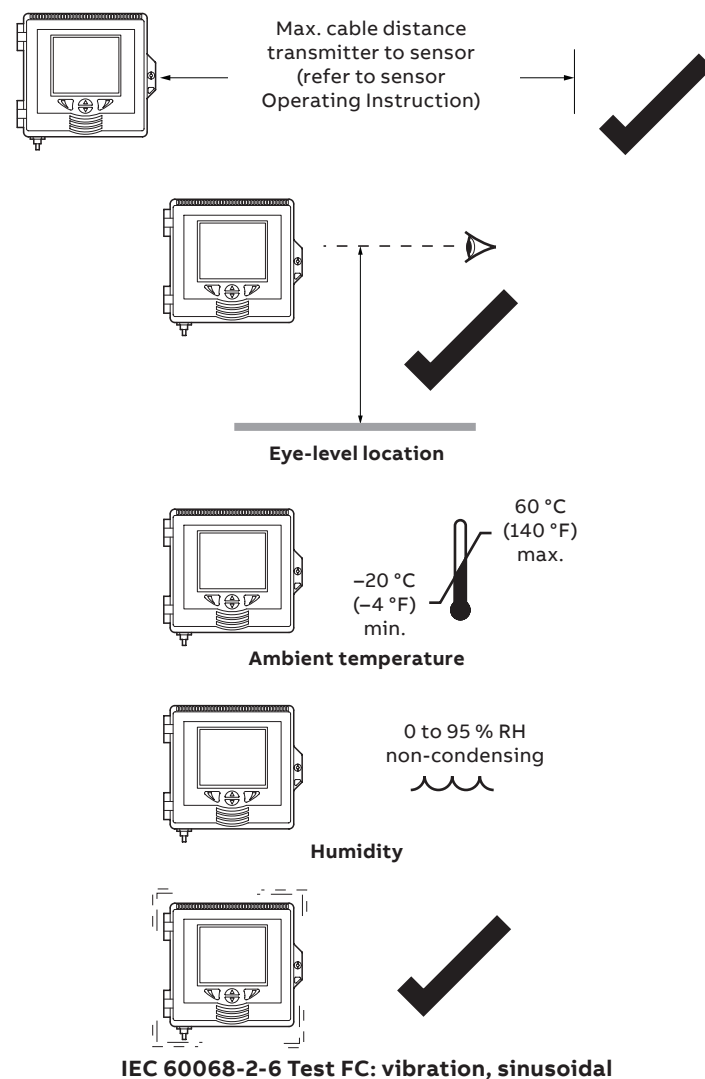

Figure 9 Transmitter location

Optional accessories (see page 36)

- Cable gland kits
- Panel-mount kit
- Pipe-mount kit

...5 Mechanical installation

...Transmitter installation

Wall mounting

Referring to Figure 10:

- 1 Position the left- and right-hand mounting brackets (A) into the recesses on the rear of the transmitter as shown and secure with the bracket securing screws. Ensure the plastic washers remain in the positions fitted.
- 2 Mark fixing centers (B) and drill suitable holes in the wall.
- 3 Secure the transmitter to the wall using 2 screws (C) (not supplied) in each mounting bracket.

NOTICE

If the optional weathershield (D) is used, position it between the transmitter and wall and pass 2 screws (C) through fixing holes (both sides) in weathershield.

Dimensions in mm (in)

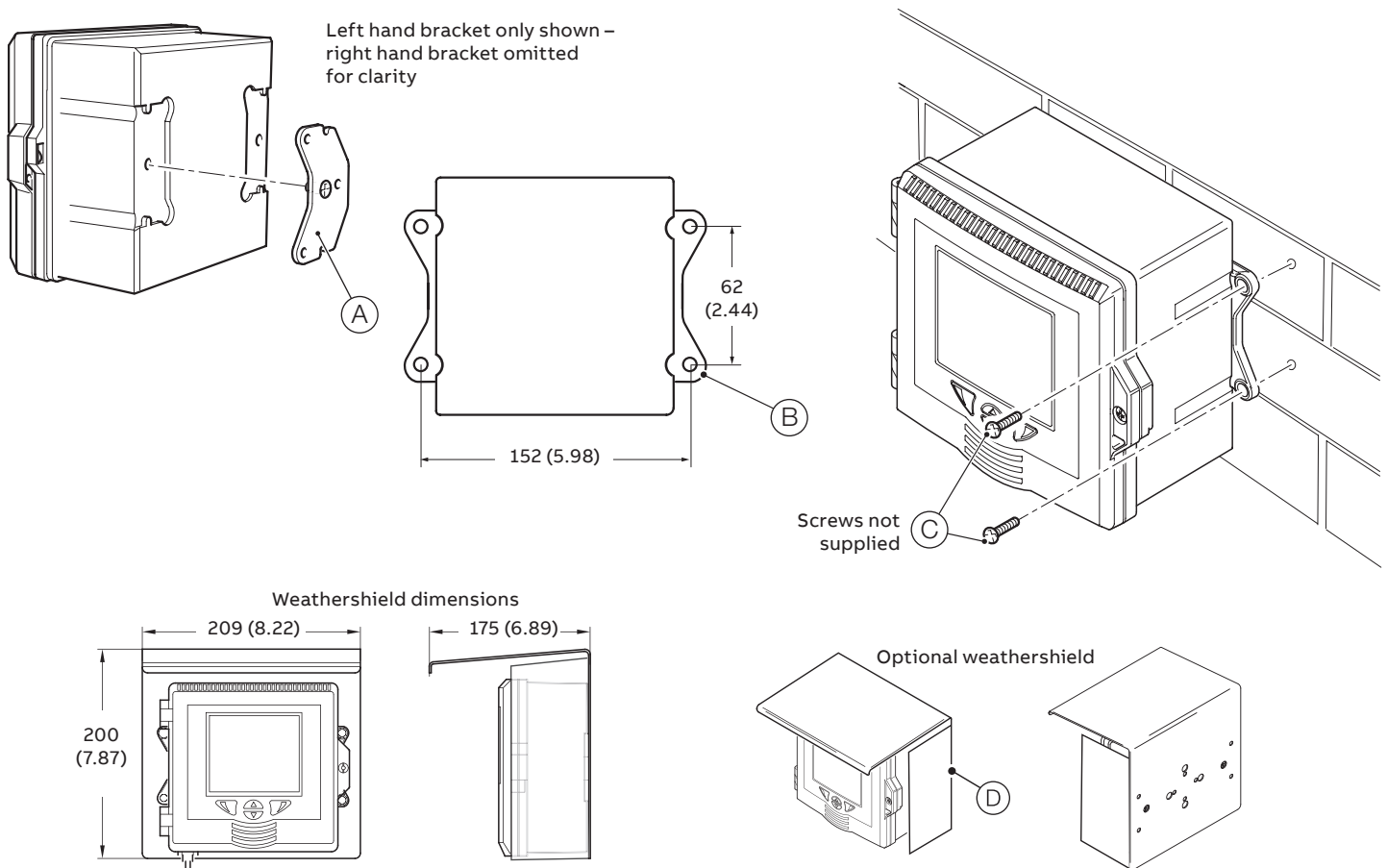

Figure 10 Wall mounting the transmitter

Panel mounting (optional)

Referring to Figure 11:

- 1 Cut the correct sized hole in panel (A).
- 2 Insert the transmitter into the panel cut-out (B).
- 3 Screw one panel clamp anchor screw (C) into the left-hand bracket (D) until 10 to 15 mm (0.39 to 0.59 in) of the thread protrudes from the other side of the bracket and position one clamp (E) over the end of the thread.
- 4 Holding assembly (F) together, position bracket (D) into the left-hand recess on the rear of the transmitter and secure with bracket securing screw (G). Ensure that the plastic washer remains in the position fitted.
- 5 Repeat steps 3 and 4 for the right-hand panel clamp assembly.
- 6 Torque each panel clamp anchor screw to 0.5 to 0.6 Nm (4.42 to 5.31 lbf-in).

NOTICE

The correct torque is critical to ensure proper compression of the panel seal and achieve the IP66/NEMA 4X hosedown rating – see step 6.

Dimensions in mm (in)

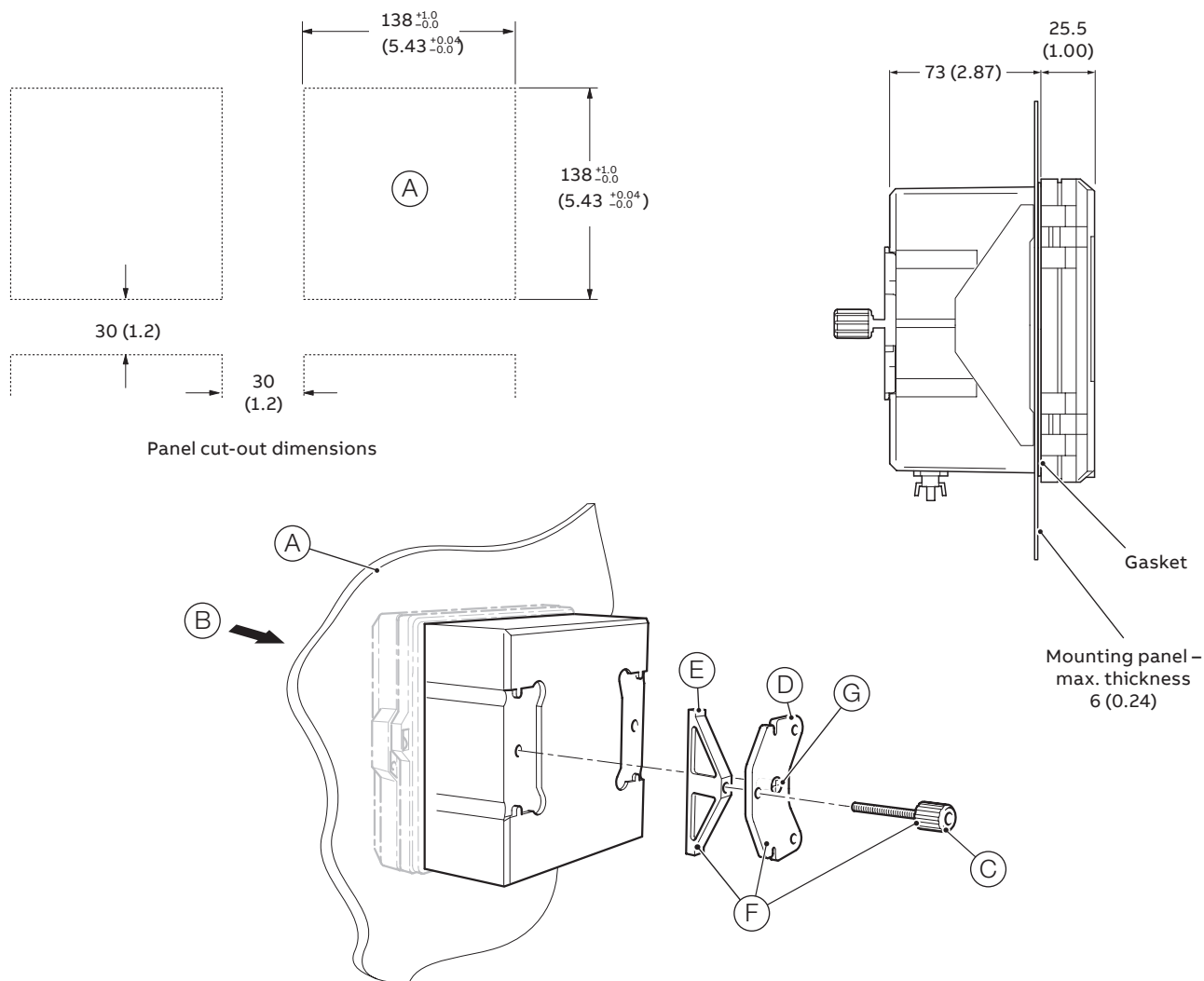

Figure 11 Panel mounting the transmitter

...5 Mechanical installation

...Transmitter installation

Pipe mounting (optional)

Referring to Figure 12, secure the transmitter to a pipe as follows:

- 1 Fit two M6 x 50 mm hexagon-head screws (A) through one clamp plate as shown.
- 2 Using the appropriate holes to suit vertical or horizontal pipe, secure the clamp plate to the pipe-mounting bracket (B) using two M6 x 8 mm hexagon-head screws and spring lock washers (C).
- 3 Position the pipe mounting bracket into the recesses on the rear of the transmitter as shown and secure with the two bracket securing screws (D). Ensure the plastic washers remain in the positions fitted.
- 4 Secure the transmitter to the pipe using the remaining clamp plate, spring lock washers and nuts (E).

NOTICE

If the optional weathershield (F) is used, locate it against the transmitter back panel and attach the pipe-mount kit to the weathershield rear face and transmitter.

Dimensions in mm (in)

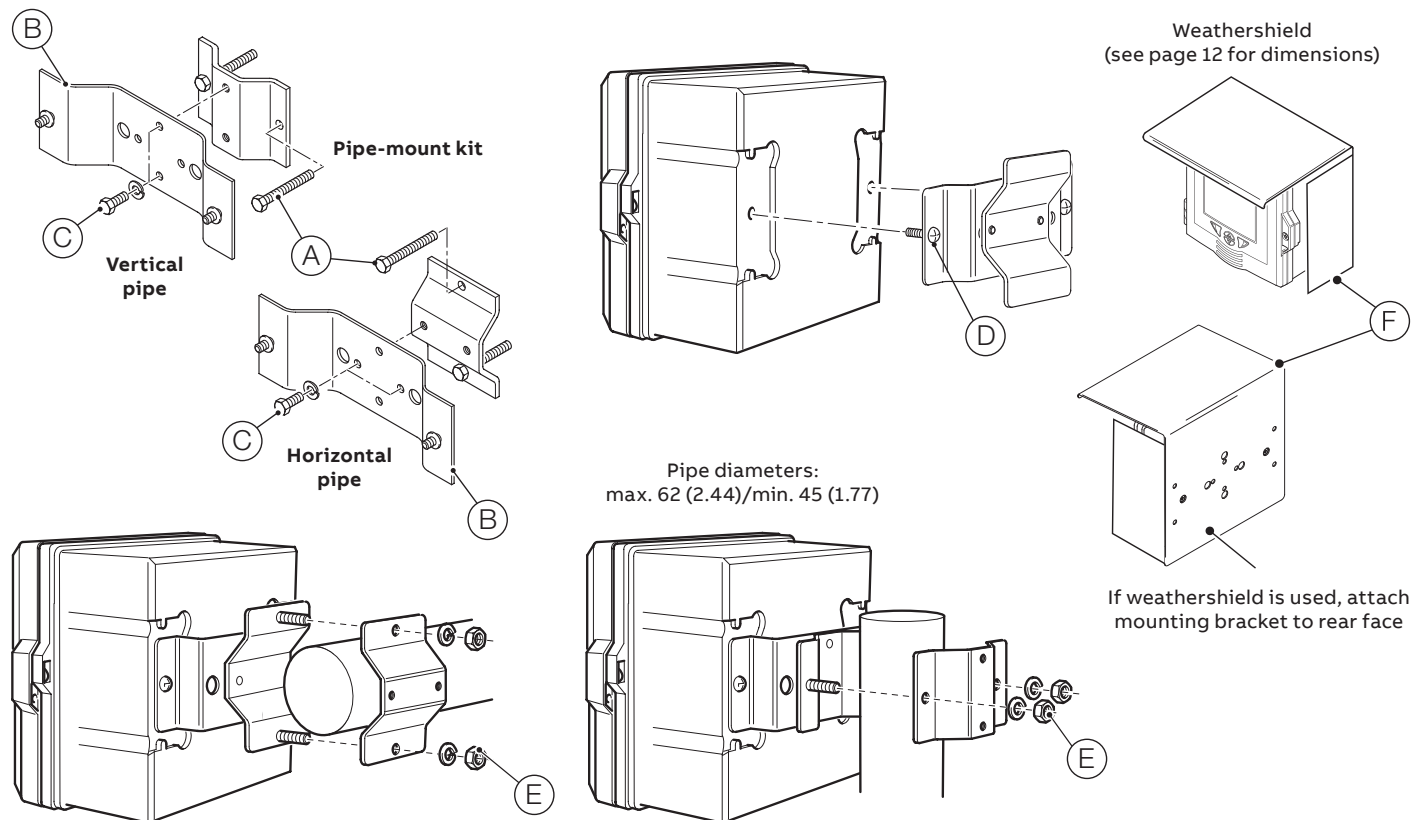

Figure 12 Pipe mounting the transmitter

6 Electrical installation

⚠ DANGER

- If the transmitter is used in a manner not specified by the Company, the protection provided by the equipment may be impaired.
- Refer to page 7 for electrical installation considerations in Hazardous areas.
- The transmitter conforms to Installation Category II of IEC 61010.
- All equipment connected to the transmitter’s terminals must comply with local safety standards (IEC 60950, EN61010-1).

⚠ DANGER – CONNECTION/CABLE REQUIREMENTS

- The connection terminals accept cables with peripheral wire cross-section of:
 - min.: 0.14 mm² (26 AWG)
 - max.: 1.5 mm² (14 AWG)
- Do not use a rigid conductor material as this can result in wire breaks.
- Ensure the connecting cable is flexible.
- To ensure the sensor cable length is sufficient, allow an additional 100 mm (4 in) of cable to pass through cable glands into the housing.
- Ensure the correct connections are made to suit the transmitter variant.

Terminal connections

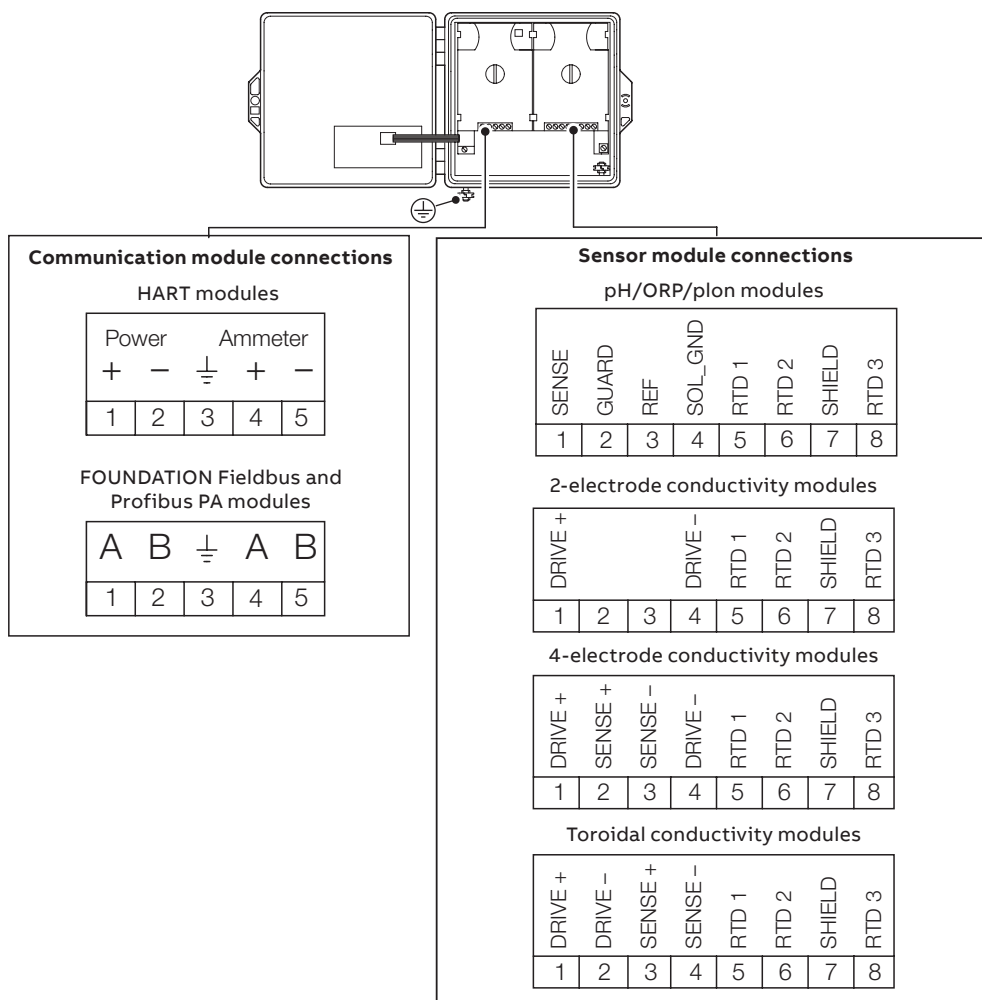

Figure 13 Connections overview

...6 Electrical installation

pH/ORP/pION sensor module connections

NOTICE

ORP (Redox) and Antimony pH sensors do not feature temperature compensation therefore do not have temperature sensors or related wiring.

Standard sensors without diagnostic functions

NOTICE

Ensure sensor diagnostics are **Off** when using standard sensors without diagnostic functions.

Sensor type	RTD wiring	SENSE 1	GUARD 2	REF 3	S.GND 4	RTD 1 5	RTD 2 6	SHIELD 7	RTD 3 8
2867	2-lead	Clear	–	Black	–	Red	White	–	–
TB5	2-lead	Blue	–	Black	–	Red	White	–	–
AP1xx	2-lead	Clear	–	Black	–	Red Red	White	–	–
	3-lead	Clear	–	Black	–	White	Red	–	Red
AP3xx	2-lead*	Blue	–	Black	–	Red	White	–	–
	3-lead	Blue	–	Black	–	Red	White	–	Grey
APS1xx	2-lead*	Blue	Yellow	Black	–	Red	White	–	–
APS5xx	3-lead	Blue	Yellow	Black	–	Red	White	–	Grey
APS7xx									

* Cut and remove grey wire

Standard sensors with diagnostic functions

NOTICE

Ensure sensor diagnostics are **On** when using standard sensors with diagnostic functions.

Sensor type	RTD wiring	SENSE 1	GUARD 2	REF 3	S.GND 4	RTD 1 5	RTD 2 6	SHIELD 7	RTD 3 8
TBX5	2-lead	Blue	Yellow	Black	Green	Red	White	Dark green	–
AP2xx	2-lead*	Clear	Red	Blue	Green/Yellow	Red	White	–	–
	3-lead	Clear	Red	Blue	Green/Yellow	Red	White	–	Grey

* Cut and remove grey wire

NOTICE

AWT210 pH sensor modules are supplied standardized to theoretical sensor characteristics. Following installation, but before use, a process calibration should be performed to ensure optimum accuracy. For pH sensor calibration procedures see Operating Instruction [OI/AWT210-EN](#).

NOTICE

BNC adaptor option

For pH/ORP/pION sensors using a BNC connector, ABB recommends using the optional BNC adaptor. ABB does not recommend stripping or cutting sensor cabling due to the nature of the signal and cabling used.

Conductivity sensor module connections

2-electrode sensors

Sensor type	RTD wiring	DRIVE + 1	2	3	DRIVE – 4	RTD 1 5	RTD 2 6	SHIELD 7	RTD 3 8
2025, 2045 2077, 2078 2085, 2089	2-lead	Red	–	–	Black	Green/ Yellow Blue	Brown	–	–
	3-lead	Red	–	–	Black	Brown	Green/ Yellow	–	Blue
TB2	2-lead	Green	–	–	Black	Blue	Yellow	Dark green	–
AC2xx	2-lead	Green	–	–	Black	Blue/Red	Yellow	Dark green	–
	3-lead	Green	–	–	Black	Yellow	Red	Dark green	Blue

NOTICE

AWT210 2-electrode conductivity sensor modules are supplied standardized to theoretical sensor characteristics. Following installation, but before use, a process calibration should be performed to ensure optimum accuracy. For 2-electrode conductivity sensor calibration procedures see Operating Instruction [OI/AWT210-EN](#).

4-electrode sensors

Sensor type	RTD wiring	DRIVE + 1	SENSE + 2	SENSE – 3	DRIVE – 4	RTD 1 5	RTD 2 6	SHIELD 7	RTD 3 8
TB4	2-lead	Green	Red	White	Black	Blue	Yellow	Dark green	–

NOTICE

AWT210 4-electrode conductivity sensor modules are supplied standardized to theoretical sensor characteristics. Following installation, but before use, a process calibration should be performed to ensure optimum accuracy. For 4-electrode conductivity sensor calibration procedures see Operating Instruction [OI/AWT210-EN](#).

Toroidal sensors

Sensor type	RTD wiring	DRIVE + 1	DRIVE – 2	SENSE + 3	SENSE – 4	RTD 1 5	RTD 2 6	SHIELD 7	RTD 3 8
TB4	2-lead	Black	Blue	White	Red	Green	Yellow	Dark green	–

NOTICE

AWT210 toroidal conductivity sensor modules are supplied standardized to theoretical sensor characteristics. Following installation, but before use, a process calibration should be performed to ensure optimum accuracy. For toroidal conductivity sensor calibration procedures see Operating Instruction [OI/AWT210-EN](#).

...6 Electrical installation

Communication module connections

HART module

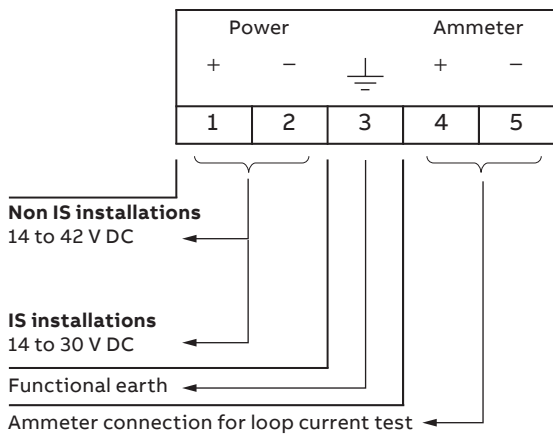

FOUNDATION Fieldbus module

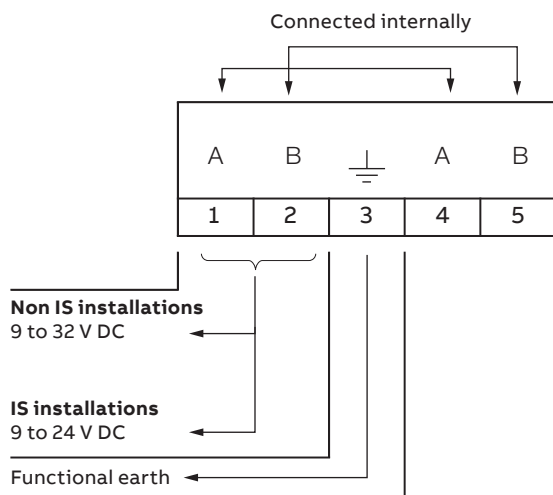

Profibus PA module

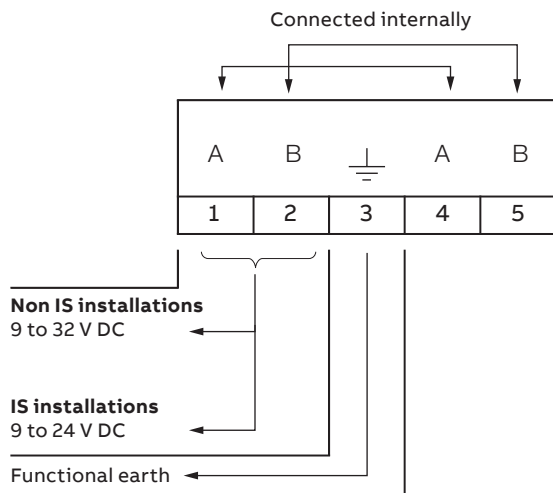

Ground connection

Normal grounding practice is to terminate all grounds at the control room side, in which case the field side of the screen should be adequately protected to avoid contact with metallic objects. The transmitter case should be grounded.

WARNING

Bodily injury

If conduit hubs are used, they will not provide a bonding of the enclosure or system.

Referring to Figure 14, ground connections are provided: internally (A) and externally (B).

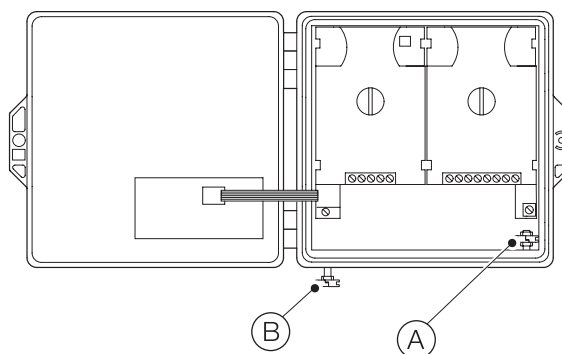

Figure 14 AWT210 ground connections

For IS systems the grounding should be at the safety barrier earth connection. For bus-powered systems the grounding of the screen should be close to the power supply unit. The specific noise immunity and emitted interference are only guaranteed when bus screening is fully effective – for example, ensuring that screening is maintained through any existing junction boxes. Appropriate equipotential bonding must be provided to avoid differences in potential among the individual plant components.

To ensure fault-free communication on Fieldbus (FF or PA) installations, the bus must be properly terminated at both ends. Only approved bus terminators must be used for intrinsically safe circuits.

NOTICE

HART, Profibus and Fieldbus protocols are not secure. Therefore, the intended application should be assessed before implementation to ensure these protocols are suitable.

Gland entries

For hazardous area installations, suitable Ex glands and blanking elements must be used to seal the entry holes.

7 Operation

Operator Page – normal conditions

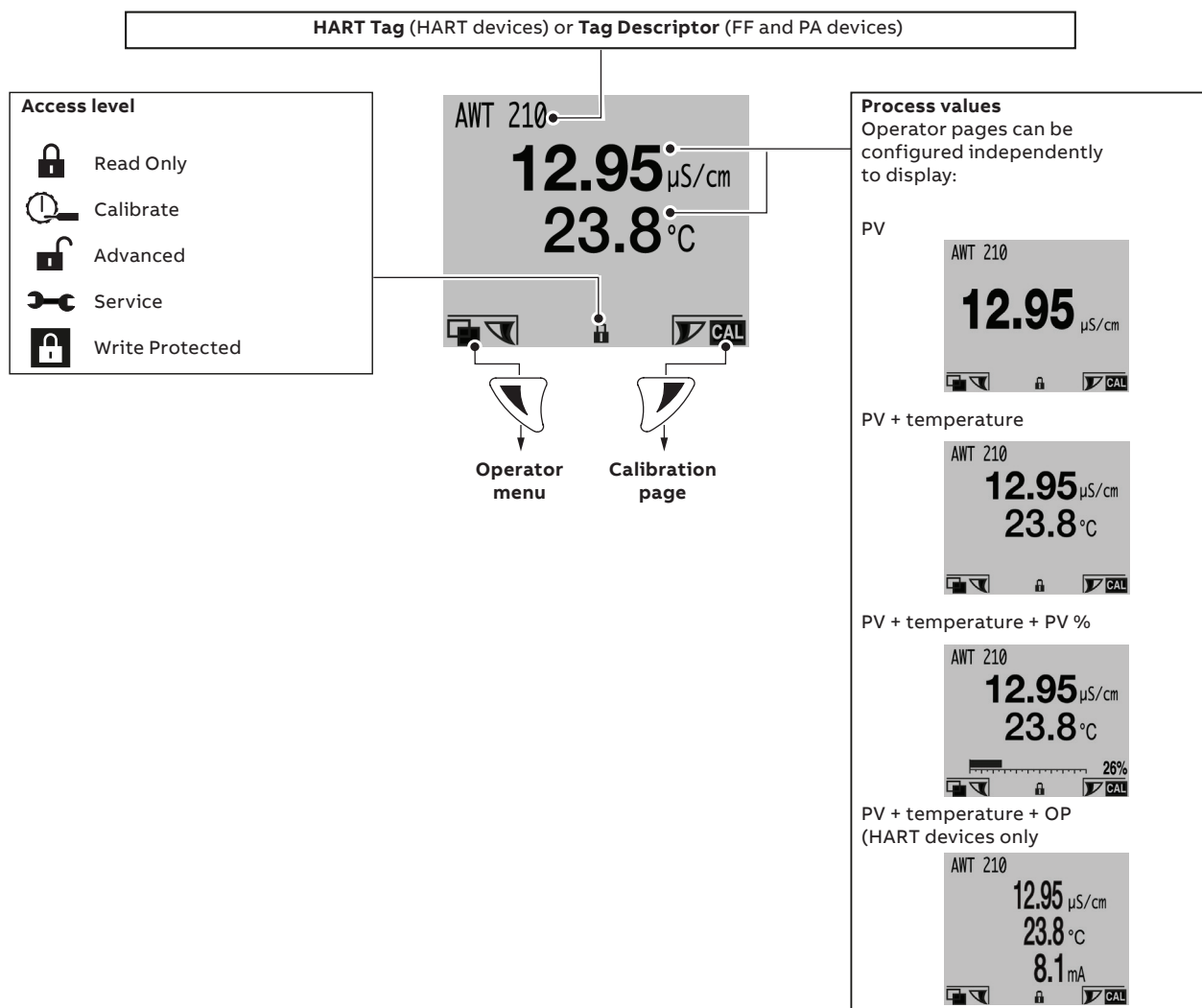

Figure 15 Example Operator pages – normal conditions

Operator Page – alarm conditions

If any of the diagnostic alarms are active the NAMUR status of the device is indicated by displaying the class and category of the highest priority active alarm.

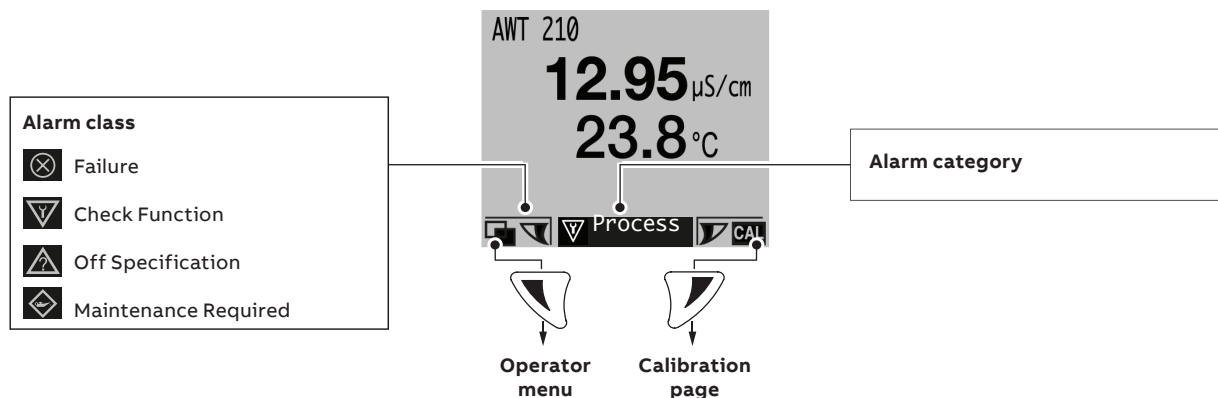
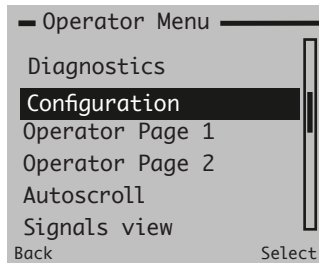

Figure 16 Example Operator pages – alarm conditions

...7 Operation

Operator menu

From the Operator menu, use the \uparrow/\downarrow keys to highlight the required menu and press the \rightarrow key to select:



Operator menus comprise:

- Diagnostics: displays a list of active diagnostic alarm messages in priority order – see page 21.
- Configuration: enters the Configuration level menus.
- Operator Page 1: displays the first Operator Page.
- Operator Page 2: displays the second Operator Page (available only if Operator Page 2 enabled).
- Autoscroll: switches automatically between the two Operator pages (available only if Operator Page 2 enabled).
- Signals View: displays a list of active signals.

Signals View

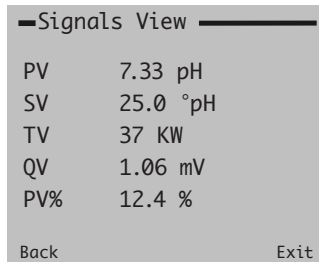

Signal	Sensor type pH	Sensor type 2-electrode conductivity	Sensor type 4-electrode conductivity	Sensor type toroidal conductivity
PV	pH, ORP, Ion Conc or pION	Conductivity or Concentration	Conductivity or Concentration	Conductivity or Concentration
SV	Temperature	Temperature	Temperature	Temperature
TV	Reference impedance	Conductivity without temperature compensation	Conductivity without temperature compensation	Conductivity without temperature compensation
QV	pH, Cell output (mV)	Conductivity	Conductivity	Conductivity
PV%	Primary variable percentage of engineering range	Primary variable percentage of engineering range	Primary variable percentage of engineering range	Primary variable percentage of engineering range
O/P	Current output (HART versions only)	Current output (HART versions only)	Current output (HART versions only)	Current output (HART versions only)

Table 1 Signals View/Sensor type values displayed

8 Diagnostic alarms

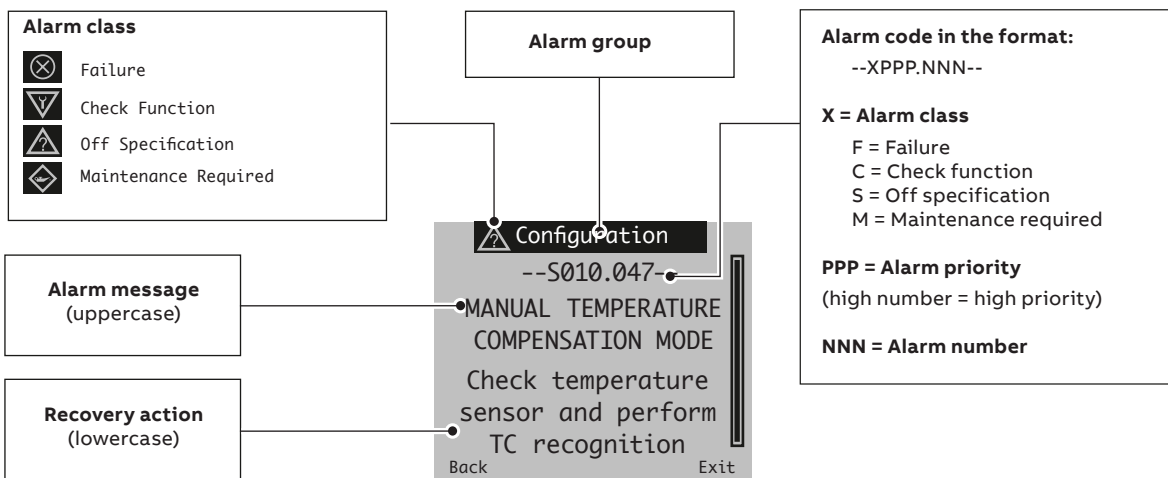



















Figure 17 Example diagnostic alarm

Note.
Alarms are listed in alarm priority order (high number = high priority alarm).

Diagnostic message	ALARM MESSAGE	Recovery action	pH	2-electrode conductivity	4-electrode conductivity	Toroidal conductivity	HART	FF	PA
Electronics --F119.018--	SENSOR MODULE MEMORY FAILURE	Change sensor module	✓	✓	✓	✓	✓	✓	✓
Electronics --F118.023--	COMMS MODULE MEMORY FAILURE	Change comms module	✓	✓	✓	✓	✓	✓	✓
Electronics --F106.032--	CURRENT OUTPUT NOT CALIBRATED	Trim output If problem persists change comms module	✓	✓	✓	✓	✓		
Configuration --C098.041--	DATA SIMULATION		✓	✓	✓	✓	✓	✓	✓
Configuration --C097.030--	CURRENT OUTPUT FIXED	Enable loop current mode. Disable loop test/trim & PV cal.	✓	✓	✓	✓	✓		
Process --C096.031--	CURRENT OUTPUT SATURATED	Adjust engineering range	✓	✓	✓	✓	✓		
Electronics --F088.016--	SENSOR MODULE FAILURE	Change sensor module	✓	✓	✓	✓	✓	✓	✓
Process --F087.040--	OPEN CABLE OR SENSOR OUT OF SOLUTION	Check sensor wiring Verify that sensor is in solution	✓				✓	✓	✓
Electronics --F086.000--	PRIMARY VARIABLE INPUT READ ERROR	Check sensor If problem persists change sensor module	✓	✓	✓	✓	✓	✓	✓
Electronics --F085.003--	2ND PRIMARY VARIABLE INPUT READ ERROR	Check sensor If problem persists change sensor module		✓			✓	✓	✓
Operation --M084.038--	SHORTED CABLE OR GROUND LOOPS PRESENT	Check sensor wiring	✓		✓		✓	✓	✓
Sensor --M083.007--	SENSOR POLARIZATION	Check process Check sensor wiring Clean sensor	✓				✓	✓	✓

Table 2 Diagnostic alarms

...8 Diagnostic alarms

Diagnostic message	ALARM MESSAGE	Recovery action	pH	2-electrode conductivity	4-electrode conductivity	Toroidal conductivity	HART	FF	PA
 Process --M082.005--	SENSOR IS DIRTY	Clean sensor			✓		✓	✓	✓
 Electronics --M081.006--	DIAGNOSTIC INPUT READ ERROR	Check terminals Check sensor wiring Check electrode			✓		✓	✓	✓
 Electronics --M080.039--	LOW ELECTRODE IMPEDANCE	Check terminals Check sensor wiring Check electrode	✓				✓	✓	✓
 Process --S078.004--	PRIMARY VARIABLE OUTSIDE PHYS. LIMITS	Check sensor wiring Check configuration	✓	✓	✓	✓	✓	✓	✓
 Process --S076.010--	PRIMARY VARIABLE OUTSIDERANGE LIMITS	Adjust engineering range	✓	✓	✓	✓	✓	✓	✓
 Electronics --S074.001--	TEMPERATURE INPUT READ ERROR	Check sensor If problem persists change sensor module	✓	✓	✓	✓	✓	✓	✓
 Process --S072.011--	SENSOR TEMPERATURE OUTSIDE LIMITS	Check sensor wiring Check temperature configuration	✓	✓	✓	✓	✓	✓	✓
 Sensor --S068.043--	HIGH SENSOR EFFICIENCY (slope)	Check calibration Clean sensor Check sensor wiring	✓				✓	✓	✓
 Sensor --F066.044--	LOW SENSOR EFFICIENCY (slope)	Check calibration Clean sensor Check sensor wiring	✓				✓	✓	✓
 Sensor --S064.045--	HIGH SENSOR OFFSET	Check calibration Clean sensor Check sensor wiring	✓				✓	✓	✓
 Sensor --S062.046--	LOW SENSOR OFFSET	Check calibration Clean sensor Check sensor wiring	✓				✓	✓	✓
 Electronics --M060.037--	DIAGNOSTIC INPUT READ ERROR	Check sensor wiring If problem persists change sensor module	✓				✓	✓	✓
 Electronics --M056.002--	REFERENCE IMPEDANCE INPUT READ ERROR	Check sensor If problem persists change sensor module	✓				✓	✓	✓
 Sensor --M054.012--	HIGH REFERENCE IMPEDANCE	Check sensor Check sensor wiring	✓				✓	✓	✓
 Operation --M024.033--	POWER SUPPLY VOLTAGE OUTSIDE LIMITS	Trim output Ensure power supply voltage is within limits	✓	✓	✓	✓	✓		
 Electronics --M023.036--	SENSOR MODULE VOLTAGE WARNING	Check sensor wiring If problem persists change sensor module	✓	✓	✓	✓	✓	✓	✓
 Configuration --S010.047--	MANUAL TEMPERATURE COMPENSATION MODE	Check temperature sensor and perform TC recognition	✓	✓	✓	✓	✓	✓	✓

...Table 2 Diagnostic alarms

9 Password security and Access Level

Passwords are entered at the Enter Password screen accessed via the Access Level – see below.

Access Level

The Access Level is entered via the Operator/Enter Configuration menu option. Use the \uparrow/\downarrow keys to highlight the required level and press \rightarrow to enter the level.

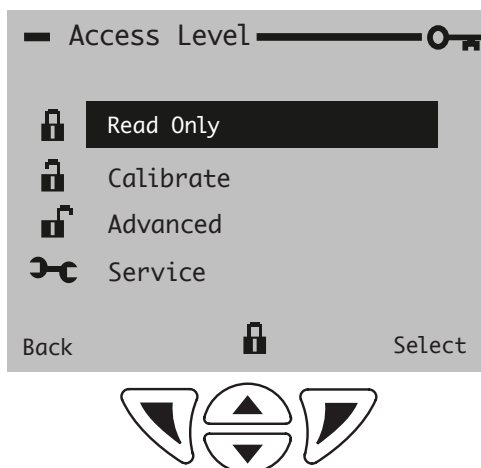

Figure 18 Access level screen

Level	Access
Logout	Displayed only after Calibrate or Advanced levels are accessed. Logs the user out of the current level. If passwords are set, a password must be entered to access these levels again after selecting Logout.
Read Only	View all parameters in read-only mode.
Calibrate	Enables access and adjustment of Calibrate level only (calibration menus are sensor-specific).
Advanced	Enables configuration access to all parameters.
Service	Reserved for authorized service technicians only.

Table 3 Access level menu details

Cursor/Password character indicator (maximum 6 characters)



Cursor – scroll characters using the \downarrow/\uparrow keys; press \rightarrow (Next) to accept character; press \rightarrow (OK) to accept password while last character is highlighted

Figure 19 Enter password screen

Write protect switch

When the Write Protect switch (see page 6) is in the ON position, the transmitter is write-protected (and the Write Protected icon  is displayed – see page 19). This means that only the Read Only access level is available to the operator.

When this switch is in the OFF position, all access levels are available (Read Only, Calibrate, Advanced and Service).

Setting passwords

Passwords can be set to enable secure access at 2 levels: Calibrate and Advanced. The Service Level is password protected at the factory and reserved for factory use only. Passwords can contain up to 6 characters and are set, changed or restored to their default settings at the Device Setup/ Security Setup parameter – see Operating Instruction [OI/AWT210-EN](#).

Note. The transmitter is supplied with blank passwords for the Calibrate and Advanced levels, therefore, the Calibrate and Advanced levels can be accessed without password protection. It is recommended to set passwords for these access levels.

Password recovery

Advanced level password recovery



To recover the Advanced level password, move the Write Protect switch to the OFF position (see page 6). Select the Service Access level and enter the Service level password to gain access. From the Service level, the Device Setup menu can be accessed to reset the Advanced level password.

Service level password recovery

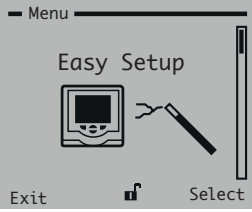
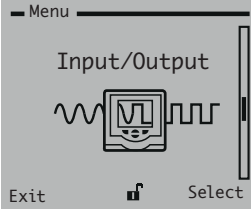
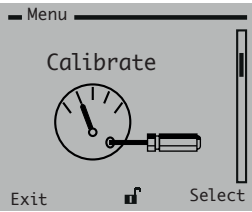
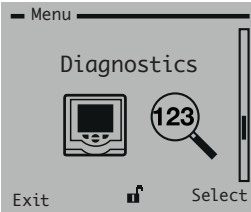
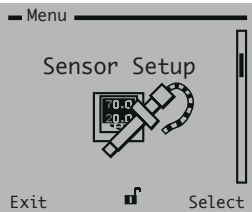
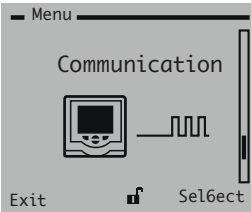

If the Service level password is lost, the only way to recover it is by following the procedure to reset all parameters to the factory default values as described in Operating Instruction [OI/AWT210-EN](#). This resets all parameters including passwords.

10 Menu overview

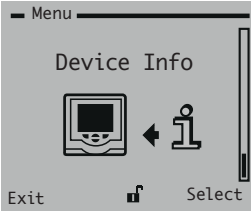
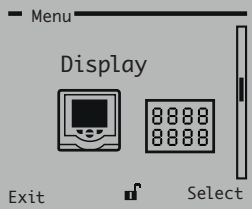
pH menus

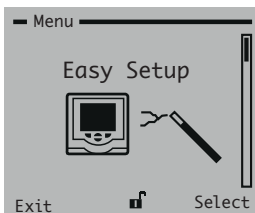
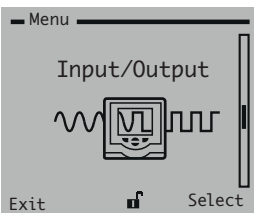
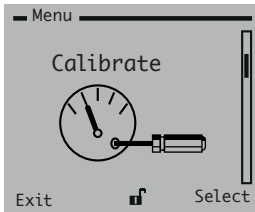
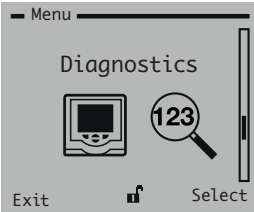
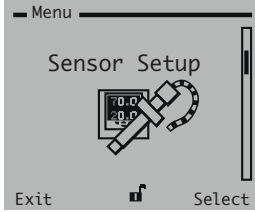
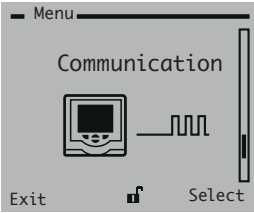

Level	pH	Level	pH
	Language Measurement Type <ul style="list-style-type: none"> • pH Sensor Type <ul style="list-style-type: none"> - Isopotential Point - Asymmetric Potential • PV Unit • Valence • Magnitude • End Magnitude • End mV Temperature Units Temp. Comp. Type <ul style="list-style-type: none"> • Manual Temperature • Solution Coefficient Operator page 1		Engineering Range Low Engineering Range High Damping Fault Current (HART only) Output Type (HART only) Function Gen Table (HART only) Trim 4mA (HART only) Trim 20mA (HART only) Loop Test (HART only)
	Automatic Buffer Cal. PV Manual Cal Temperature Cal Hold Output (HART only) <ul style="list-style-type: none"> • Auto Buffer Setup <ul style="list-style-type: none"> - Temperature Compensation Coefficient - Buffer Type - Buffer 1 Value - Buffer 2 Value - User Defined Buffer 1 - User Defined Buffer 2 Calibration Limits Edit Calibration Restore Defaults		Sensor Diagnostics Reference Impedance Limit Diagnostic Status
	Measurement Type <ul style="list-style-type: none"> • pH Sensor Type <ul style="list-style-type: none"> - Isopotential Point - Asymmetric Potential • PV Unit • Valence • Magnitude • End Magnitude • End mV Temperature Units Temperature Compensation Type <ul style="list-style-type: none"> • Manual Temperature • Solution Coefficient Temperature Sensor Type Detect Temperature Sensor		HART version: Device Address HART Tag HART Description Message Manuf. ID Last Command HART Revision Resp. Preamble Loop Current Mode PA version: Slave Address Device Tag Ident No. Selector Manuf. ID Device Type PA Profile Foundation Fieldbus version Node Address Device Tag Manuf. ID Device Type Device Revision Simulation
	Security Setup PDM Compatibility (HART only) Reset to defaults		Sensor Type Device Serial No. Software Version
	Operator Page 1 Operator Page 2 Contrast Language		

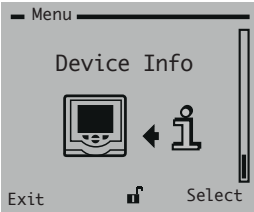
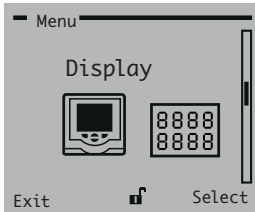
2-electrode conductivity menus



Level	2-electrode conductivity	Level	2-electrode conductivity
	Language Measurement Type Cell Constant <ul style="list-style-type: none"> • Concentration Units • Concentration Curve Name Temperature Units Operator page 1		Engineering Range Low Engineering Range High Damping Fault Current (HART only) Output Type (HART only) Function Gen Table (HART only) Trim 4mA (HART only) Trim 20mA (HART only) Loop Test (HART only)
	Conductivity Calibration Concentration Calibration Temperature Calibration Hold Output (HART only) Edit Calibration Restore Defaults		Sensor Diagnostics Diagnostic Status
	Measurement Type Cell Constant <ul style="list-style-type: none"> • Concentration Units • Conductivity Units • Concentration Curve Name <ul style="list-style-type: none"> - Concentration Curve Table Temperature Units Temperature Compensation Type <ul style="list-style-type: none"> • Manual Temperature • Auto Temperature Compensation Option <ul style="list-style-type: none"> - Temperature Compensation Coefficient - Pure H2O Type - User Defined Temperature Compensation Curve Reference Temperature Temperature Sensor Type Detect Temperature Sensor		HART version: Device Address HART Tag HART Description Message Manuf. ID Last Command HART Revision Resp. Preamble Loop Current Mode PA version: Slave Address Device Tag Ident No. Selector Manuf. ID Device Type PA Profile Foundation Fieldbus version Node Address Device Tag Manuf. ID Device Type Device Revision Simulation
	Security Setup PDM Compatibility (HART only) Reset to defaults		Sensor Type Device Serial No. Software Version
	Operator Page 1 Operator Page 2 Contrast Language		

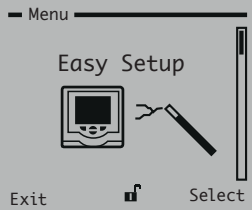
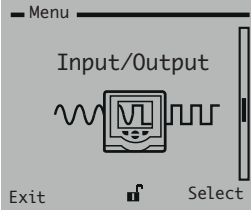
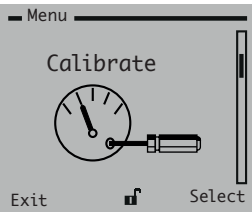
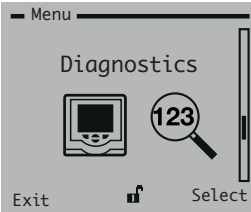
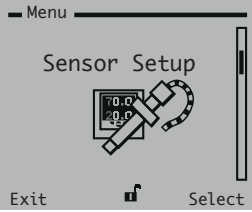
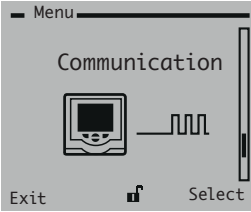

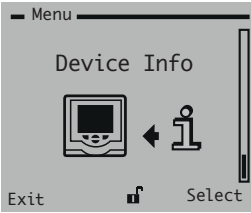
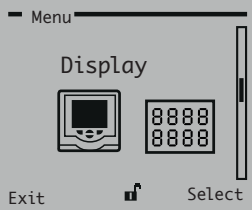
...10 Menu overview

4-electrode conductivity menus

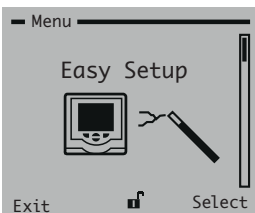
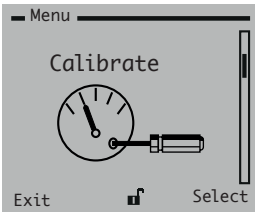
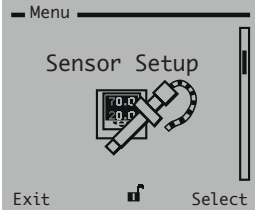
Level	4-electrode conductivity	Level	4-electrode conductivity
	Language Measurement Type Sensor Group <ul style="list-style-type: none"> • Concentration Units • Concentration Curve Name Temperature Units Operator page 1		Engineering Range Low Engineering Range High Damping Fault Current (HART only) Output Type (HART only) Function Gen Table (HART only) Trim 4mA (HART only) Trim 20mA (HART only) Loop Test (HART only)
	Conductivity Calibration Concentration Calibration Temperature Calibration Hold Output (HART only) Edit Calibration Restore Defaults		Sensor Diagnostics Diagnostic Status
	Measurement Type Sensor Group <ul style="list-style-type: none"> • Concentration Units • Conductivity Units • Concentration Curve Name <ul style="list-style-type: none"> - Concentration Curve Table Temperature Units Temperature Compensation Type <ul style="list-style-type: none"> • Manual Temperature • Auto Temperature Compensation Option <ul style="list-style-type: none"> - Temperature Compensation Coefficient - User Defined Temperature Compensation Curve Reference Temperature Temperature Sensor Type Detect Temperature Sensor		HART version: Device Address HART Tag HART Description Message Manuf. ID Last Command HART Revision Resp. Preamble Loop Current Mode PA version: Slave Address Device Tag Ident No. Selector Manuf. ID Device Type PA Profile Foundation Fieldbus version Node Address Device Tag Manuf. ID Device Type Device Revision Simulation
	Security Setup PDM Compatibility (HART only) Reset to defaults		Sensor Type Device Serial No. Software Version
	Operator Page 1 Operator Page 2 Contrast Language		

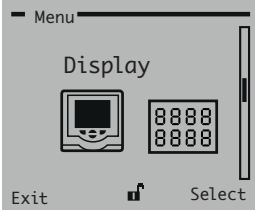
Toroidal conductivity menus

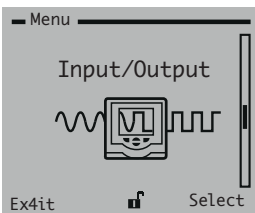
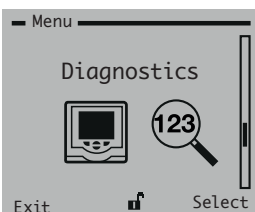
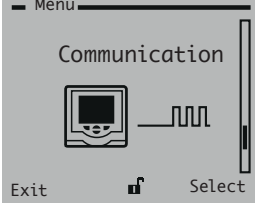
Level	Toroidal conductivity
	Language Measurement Type Concentration Solution <ul style="list-style-type: none"> • Concentration Units • Concentration Curve Name Temperature Units Operator page 1
	PV Zero Calibration PV Span Calibration Temperature Calibration Hold Output (HART only) Edit Calibration Restore Defaults
	Measurement Type <ul style="list-style-type: none"> • Concentration Solution • Concentration Units • Conductivity Units • Concentration Curve Name <ul style="list-style-type: none"> - Concentration Curve Table Temperature Units Temperature Compensation Type <ul style="list-style-type: none"> • Manual Temperature • Auto Temperature Compensation Option <ul style="list-style-type: none"> - Temperature Compensation Coefficient - User Defined Temperature Compensation Curve Reference Temperature Temperature Sensor Type Detect Temperature Sensor
	Security Setup PDM Compatibility (HART only) Reset to defaults
	Operator Page 1 Operator Page 2 Contrast Language

Level	Toroidal conductivity
	Engineering Range Low Engineering Range High Damping Fault Current (HART only) Output Type (HART only) Function Gen Table (HART only) Trim 4mA (HART only) Trim 20mA (HART only) Loop Test (HART only)
	Sensor Diagnostics Diagnostic Status
	HART version: Device Address HART Tag HART Description Message Manuf. ID Last Command HART Revision Resp. Preamble Loop Current Mode PA version: Slave Address Device Tag Ident No. Selector Manuf. ID Device Type PA Profile Foundation Fieldbus version Node Address Device Tag Manuf. ID Device Type Device Revision Simulation
	Sensor Type Device Serial No. Software Version

11 Calibration

pH sensor calibration

Auto Buffer Cal

Performs a 2 point calibration using 2 pre-defined buffer solutions – see **Auto Buffer Setup**, page 24.

Available only if **Measurement Type = pH**.

1 Immerse in Buffer 1

The details of buffer solution 1 are displayed.

Immerse the sensor in the buffer solution and press  to continue.

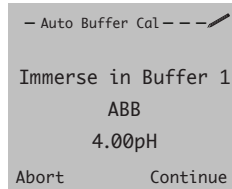

2 Monitoring (Buffer 1)

Live process values are displayed. The progress of the process value stability check is indicated on the progress bar. The procedure moves automatically to the next stage upon completion.

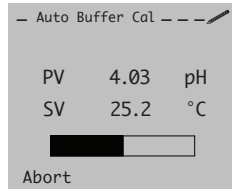

3 Immerse in Buffer 2

The details of buffer solution 2 are displayed.

Immerse the sensor in the buffer solution and press  to continue.

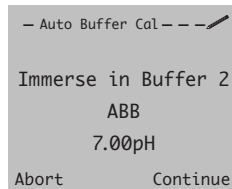

4 Monitoring (Buffer 2)

Live process values are displayed. The progress of the process value stability check is indicated on the progress bar. The procedure moves automatically to the next stage upon completion.

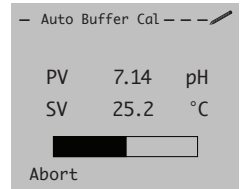

5 Completion

Following a successful calibration the calculated coefficients are displayed.

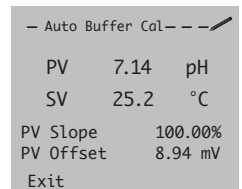

Following an unsuccessful calibration the reason for failure is displayed.

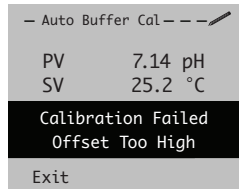

1-point manual calibration

Performs a manual calibration (Offset adjustment) at a single reference point.

1 Wait for stable reading

Monitor the process value and continue (F7) to the next step once the value has stabilized.

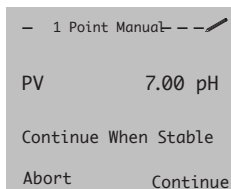

2 Enter the new value

Enter the desired PV value by pressing the (F7) key to move the cursor and the (F8) (F9) keys to change the value. When the new value has been entered press the (F7) key to continue.

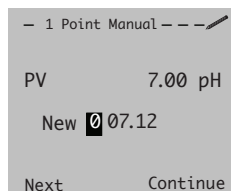

3 Completion

Following a successful calibration the calculated coefficients are displayed.

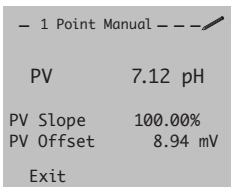

Following an unsuccessful calibration the reason for failure is displayed.

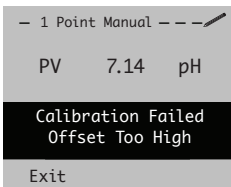

2-point manual calibration

Performs a 2-point calibration using 2 pre-defined buffer solutions.

1 Buffer temperature

The temperature of the buffer solutions is displayed. The temperature can be edited by pressing the (F7) key. When the buffer temperature is correct press the (F8) key to continue.

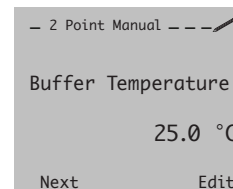

2 Buffer 1 value

The value of the 1st buffer solution is displayed. The value can be edited by pressing the (F7) key. When the buffer value is correct press the (F8) key to continue.

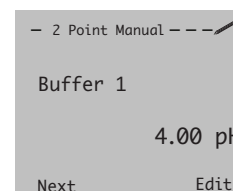

3 Wait for stable reading – 1st buffer solution

Immerse the sensor in the buffer solution, monitor the process value and continue (F7) to the next step once the value has stabilized.

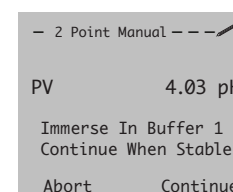

4 Buffer 2 value

The value of the 2nd buffer solution is displayed. The value can be edited by pressing the (F7) key. When the buffer value is correct press the (F8) key to continue.

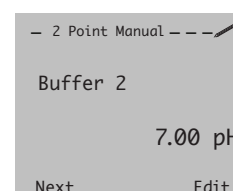

5 Wait for stable reading – 2nd buffer solution

Immerse the sensor in the buffer solution, monitor the process value and continue (F7) to the next step once the value has stabilized.

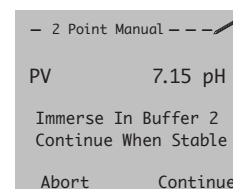

6 Completion

Following a successful calibration the calculated coefficients are displayed.

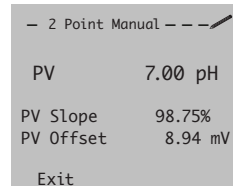

Following an unsuccessful calibration the reason for failure is displayed.

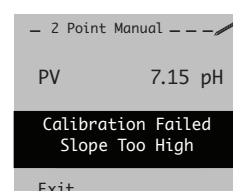

...11 Calibration

2-electrode conductivity sensor calibration

2-electrode conductivity does not normally require wet calibration provided that the sensor constant has been entered correctly and the sensor cable resistance is not significant. The procedure is for a manual calibration at a single reference point. **Conductivity Calibration** and **Concentration Calibration** procedures are identical.

For cell constants from 0.003 to 0.054

- If the calibration is performed at a conductivity value $< 0.2 \mu\text{S/cm}$ the **PV Offset** is recalculated.
- If the calibration is performed at a conductivity value $\geq 0.2 \mu\text{S/cm}$ the **PV Slope** is recalculated.

For cell constants from 0.055 to 0.299

- If the calibration is performed at a conductivity value $< 1 \mu\text{S/cm}$ the **PV Offset** is recalculated.
- If the calibration is performed at a conductivity value $\geq 1 \mu\text{S/cm}$ the **PV Slope** is recalculated.

For cell constants from 0.3 to 1.999

- If the calibration is performed at a conductivity value $< 5 \mu\text{S/cm}$ the **PV Offset** is recalculated.
- If the calibration is performed at a conductivity value $\geq 5 \mu\text{S/cm}$ the **PV Slope** is recalculated.

1 Wait for stable reading

Monitor the process value and continue (↵) to the next step once the value has stabilized.

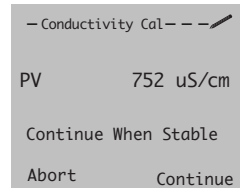

2 Enter the new value

Enter the desired PV value by pressing the ↵ key to move the cursor and the ▲ ▼ keys to change the value. When the new value has been entered press the ↵ key to continue.

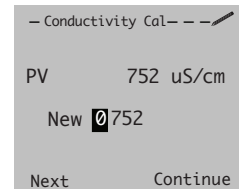

3 Completion

Following a successful calibration the calculated coefficients are displayed.

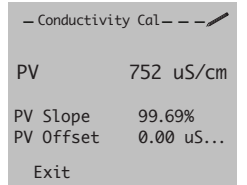

Following an unsuccessful calibration the reason for failure is displayed.

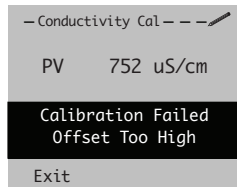

4-electrode conductivity sensor calibration

4-electrode conductivity may require wet calibration for the greatest accuracy.

The procedure is for a manual calibration at a single reference point. **Conductivity Calibration** and **Concentration Calibration** procedures are identical.

For Group A sensors

- If the calibration is performed at a conductivity value <1 μS/cm the PV Offset is recalculated.
- If the calibration is performed at a conductivity value ≥1 μS/cm the PV Slope is recalculated.

For Group B sensors

- If the calibration is performed at a conductivity value <5 μS/cm the PV Offset is recalculated.
- If the calibration is performed at a conductivity value ≥ 5μS/cm the PV Slope is recalculated.

1 Wait for stable reading

Monitor the process value and continue (↵) to the next step once the value has stabilized.

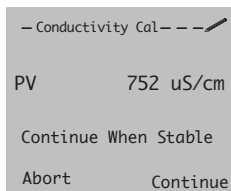

2 Enter the new value

Enter the desired PV value by pressing the ↵ key to move the cursor and the ▲ ▼ keys to change the value. When the new value has been entered press the ↵ key to continue.

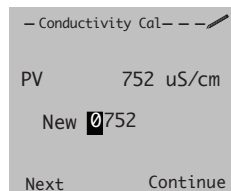

3 Completion

Following a successful calibration the calculated coefficients are displayed.

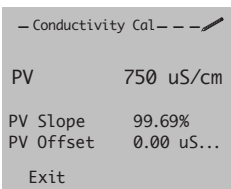

Following an unsuccessful calibration the reason for failure is displayed.

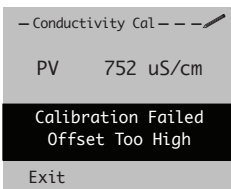

Toroidal conductivity sensor calibration

Toroidal conductivity may require wet calibration for the greatest accuracy.

PV Zero calibration

1 Apply zero and wait for stable reading

Ensure that a zero solution is present at the sensor, monitor the process value and continue (↵) to the next step once the value has stabilized.

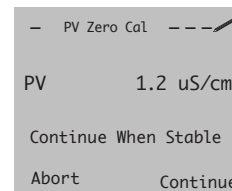

2 Sampling

The procedure moves automatically to the next stage once the PV has been sampled.

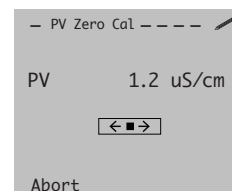

3 Completion

Following a successful calibration the calculated coefficients are displayed.

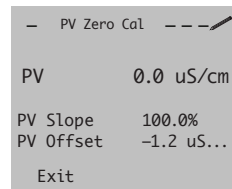

Following an unsuccessful calibration the reason for failure is displayed.

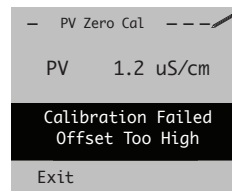

...11 Calibration

...Toroidal conductivity sensor calibration

PV Span calibration

1 Apply span and wait for stable reading

Ensure that a span solution is present at the sensor, monitor the process value and continue (✓) to the next step once the value has stabilized.

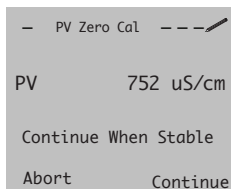

2 Enter the new value

Enter the desired PV value by pressing the (↵) key to move the cursor and the (▲) (▼) keys to change the value. When the new value has been entered press the (✓) key to continue.

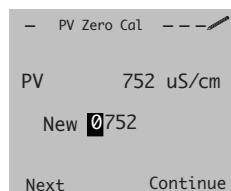

3 Sampling

The procedure moves automatically to the next stage once the PV has been sampled.

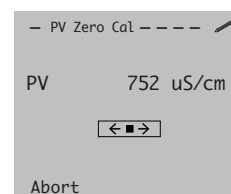

4 Completion

Following a successful calibration the calculated coefficients are displayed.

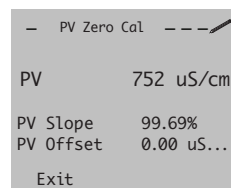

Following an unsuccessful calibration the reason for failure is displayed.

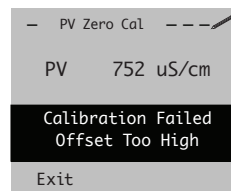

12 Specification

Operation

Display/LCD (W x H)

75 x 65 mm (3.0 x 2.55 in)

Mechanical data

Terminal connections

AWG 26 to 14 (0.14 to 2.5 mm²)

Input

pH/ORP/plon sensor types

pH: Glass, Antimony (Sb)

ORP: (Redox): Platinum (Pt), Gold (Au)

pION: Custom user-programmable

Input impedance

>1x10¹³Ω

pH/ORP/plon measurement range and resolution

Type	Range	Display resolution	Accuracy repeatability
pH	0 to 14 pH (-2 to 16 over range)	0.01 pH	±0.01 pH
ORP	-1500 to 1500 mV	1 mV	±1 mV
pION	-1500 to 1500 mV	1 mV	±1 mV

Dynamic response

<1 second for 90 % step change at 0 seconds damping

Damping

Configurable: 0 to 99.9 seconds

Conductivity sensor types

AWT210: ABB 2-electrode conductivity sensors

AWT210: ABB 4-electrode conductivity sensors

AWT210: ABB toroidal conductivity sensors

Conductivity measurement range and resolution

AWT210 2-electrode conductivity transmitter:

Cell constant	Conductivity range	Display resolution	Accuracy repeatability
0.01	0 to 200 μS/cm	0.001 μS/cm	±1.0 % of measurement range per decade
0.1	0 to 2000 μS/cm	0.01 μS/cm	
1	0 to 20000 μS/cm	0.1 μS/cm	

AWT210 4-electrode conductivity transmitter:

Sensor group	Conductivity range	Display resolution	Accuracy repeatability
A	0 to 2000 mS/cm	0.1 μS/cm	±0.5 % of measurement range per decade
B	0 to 2000 μS/cm	0.01 μS/cm	

...Conductivity measurement range and resolution

AWT210 toroidal conductivity transmitter:

Sensor	Conductivity range	Display resolution	Accuracy repeatability
ABB toroidal	0 to 2000 mS/cm	1.0 μS/cm	±0.5 % of measurement range per decade

Temperature input

Temperature element types

Pt100 (2 or 3-wire) Automatic temperature compensation

Pt1000 (2 or 3-wire) Automatic temperature compensation

3k Balco (2 or 3-wire) Automatic temperature compensation

None Manual temperature compensation

Measurement range and resolution

Temperature element	Temperature range	Accuracy Repeatability
Pt100	-20 to 200 °C (-4 to 392 °F)	±0.1 °C (±0.18 °F)
Pt1000		(±0.18 °F)
3K Balco		- after calibration
None	User-programmable 20 to 300 °C (-4 to 572 °F)	N/A

pH/ORP/plon temperature compensation modes

Type	Manual	Automatic Nernstian	Nernstian with solution coefficient	Solution compensation coefficient
pH	✓	✓	✓	
ORP	✓			✓
pION	✓			✓

Conductivity temperature compensation modes

Temperature element	AWT210 2-electrode	AWT210 4-electrode	AWT210 toroidal
0 to 15 % NaOH		✓	✓
0 to 20 % NaCl		✓	✓
0 to 18 % HCl		✓	✓
0 to 20 % H ₂ SO ₄		✓	✓
Pure water neutral salt	✓		
Pure water trace base	✓		
Pure water trace acid	✓		
User-defined	✓		✓

...12 Specification

Power supply (FF models and PA models)

Supply voltage

- 9 to 32 V DC (General purpose installations)
- 9 to 24V DC (Intrinsically Safe Ex ia)

Quiescent current

- 15 mA quiescent current consumption

Power supply (HART models)

Supply voltage

- 14 to 42 V DC (General purpose installations)
- 14 to 30 V DC (Intrinsically safe Ex ia installations)
- Polarity safe
- Lift off voltage: 14 V DC

Under-voltage protection

- Supply voltage < 12 V DC results in < 3.8 mA

Maximum permissible ripple

- Maximum ripple for supply voltage during communication in accordance with HART FSK physical layer specification, version 8.1 (08/1999) section 8.1

Maximum load

- Max. load = (supply voltage – 14 V)/22 mA

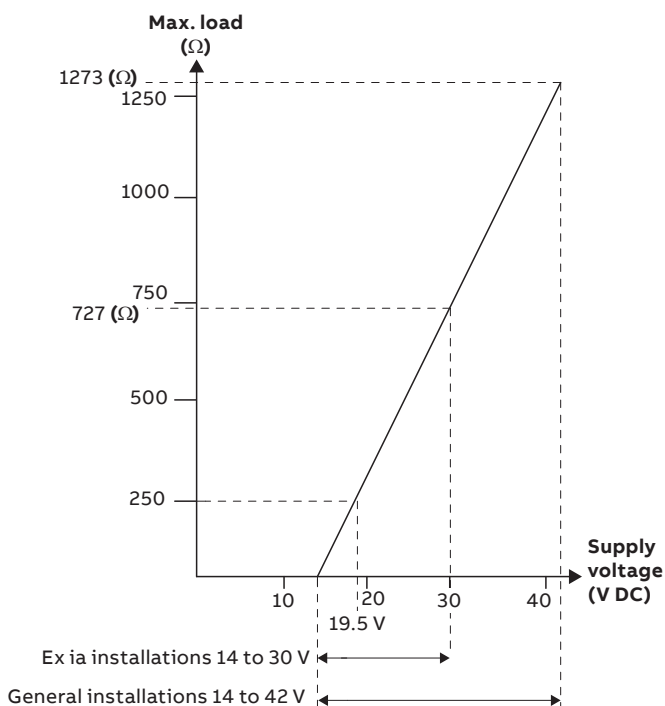

With 250 Ω resistor for HART communication min. supply voltage = 19.5 V DC

Output (HART models)

Configured range

- 4 to 20 mA, User-programmable across measurement range.
- Linear and non-linear.

AWT210 2-electrode pH transmitter:

Type	Min. span	Max. span
pH	1 pH	14 pH
ORP	100 mV	3000 mV
pION	100 mV	3000 mV

AWT210 2-electrode conductivity transmitter:

Cell constant	Min. span	Max. span
0.01	1 μS/cm	200 μS/cm
0.1	10 μS/cm	2000 μS/cm
1	100 μS/cm	20000 μS/cm

AWT210 4-electrode conductivity transmitter:

Sensor group	Min. span	Max. span
A	100 μS/cm	2000 mS/cm
B	10 μS/cm	2000 μS/cm

AWT210 toroidal conductivity transmitter:

Sensor group	Min. span	Max. span
ABB toroidal	100 μS/cm	2000 mS/cm

All conductivity models

– when configured for concentration:

Sensor group	Min. span	Max. span
All	5 % when configured for concentration	2000

Dynamic range

- 3.8 to 20.5 mA with 3.6 mA low alarm level, 21 mA high alarm level

Environmental data

Operating temperature

- 20 to 60 °C (–4 to 140 °F)

Humidity

- < 95 % RH non-condensing

Storage temperature

- 40 to 70 °C (–40 to 158 °F)

Vibration

- IEC 60068-2-6 Test FC: vibration, sinusoidal

Approvals, certification and safety

Factory Mutual (FM) Intrinsic Safety

Available with polycarbonate & aluminium enclosures

Intrinsic Safety

- Class I, Div 1, Group A, B, C, D, T4
- Class II, Div 1, Group E, F, G, T4
- Exia

Enclosure type/ingress protection classification

- 4X*/IP66

Ambient temperature range

- $-25\text{ °C} \leq Ta \leq 60\text{ °C}$

Factory Mutual (FM) Non-incendive

Available with aluminium enclosure only

Non-incendive

- Class I, Div 2, Group A, B, C, D, T4
- Class II, Div 2, Group F, G, T4
- Class III

Enclosure type/ingress protection classification

- 4X*/IP66

Ambient temperature range

- $-25\text{ °C} \leq Ta \leq 60\text{ °C}$

Canadian Standards Authority (CSA) Intrinsic Safety

Available with polycarbonate & aluminium enclosures

Intrinsic Safety

- Class I, Div 1, Group A, B, C, D, T4
- Class II, Div 1, Group E, F, G, T4
- Exia

Enclosure type/ingress protection classification

- 4X*/IP66

Ambient temperature range

- $-25\text{ °C} \leq Ta \leq 60\text{ °C}$

Canadian Standards Authority (CSA) Non-incendive

Available with aluminium enclosure only

Non-incendive

- Class I, Div 2, Group A, B, C, D, T4
- Class II, Div 2, Group F, G, T4
- Class III

Enclosure type/ingress protection classification

- 4X*/IP66

Ambient temperature range

- $-25\text{ °C} \leq Ta \leq 60\text{ °C}$

ATEX Intrinsic Safety

Available with polycarbonate & aluminium enclosures

Intrinsic Safety

- II 1G Ex ia IIC T4 Ga when used with appropriate barriers

Ingress protection classification

- IP66

Ambient temperature range

- $-20\text{ °C} \leq Ta \leq 60\text{ °C}$

IECEx Intrinsic Safety

Available with polycarbonate & aluminium enclosures

Intrinsic Safety

- II 2G Ex ia IIC T4 Ga when used with appropriate barriers

Ingress protection classification

- IP66

Ambient temperature range

- $-20\text{ °C} \leq Ta \leq 60\text{ °C}$

EMC

Emissions and immunity

Meets requirements of IEC61326 for an industrial environment.

*4X Hosedown self-assessed not approved by 3rd party.

DS/AWT210-EN Rev. E

13 Spare parts

Communications module assemblies

Part number	Description
3KXA877210L0051	HART module
3KXA877210L0052	PA module
3KXA877210L0053	FF module

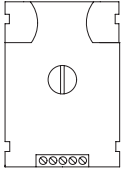

Sensor module assemblies

Part number	Description
3KXA877210L0014	pH/ORP module for use with analog sensors
3KXA877210L0013	2-electrode conductivity module
3KXA877210L0011	4-electrode conductivity module
3KXA877210L0012	toroidal conductivity module

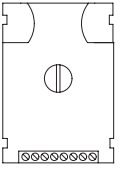

Main case assemblies

Part number	Description
AWT210A1Y0Y0Y0	Polycarbonate case assembly: CE label
AWT210A1Y0Y0E5	Polycarbonate case assembly: ATEX/IECEX label – FM/CSA label
AWT210A2Y0Y0Y0	Aluminium case assembly: CE label
AWT210A2Y0Y0E6	Aluminium case assembly: ATEX/IECEX label – FM/CSA label

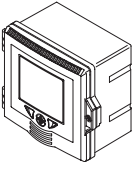

Gland packs

Glands (packs of 2)

Part number	Description
3KXA877210L0112	M16 standard gland
3KXA877210L0115	M16 Exe gland
3KXA877210L0111	M20 standard gland
3KXA877210L0114	M20 Exe gland
3KXA877210L0113	½ in NPT standard gland
3KXA877210L0116	½ in NPT Exe gland

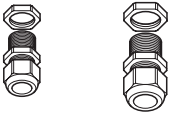

M16 M20 | ½ in

Mounting kits

Panel-mount kit

Part number	Description
3KXA877210L0101	Panel-mount kit, including fixings, flanges, clamps and seal

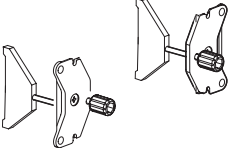

Pipe-mount kit

Part number	Description
3KXA877210L0102	Pipe-mount kit, including pipe-mount adaptor plate, brackets and fixings (excludes pipe)

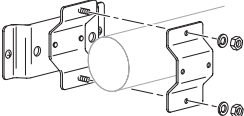

Wall-mount kit

Part number	Description
3KXA877210L0105	Wall-mount kit

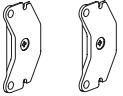

Weathershield kit

Weathershield kit

Part number	Description
3KXA877210L0103	Weathershield kit (suitable for AWT210/AWT420)



Weathershield and pipe-mount kit

Part number	Description
3KXA877210L0104	Weathershield and pipe-mount kit (suitable for AWT210/AWT420)

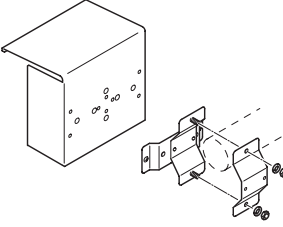

Acknowledgments

- Fieldbus is a registered trademark of the Fieldbus Foundation
- HART is a registered trademark of the FieldComm Group
- Modbus is a registered trademark of Schneider Electric USA Inc.
- PROFIBUS is a registered trademark of PROFIBUS organization

Notes

...Notes

ABB Limited**Measurement & Analytics**

Oldends Lane, Stonehouse
Gloucestershire, GL10 3TA
UK

Tel: +44 (0)1453 826 661

Fax: +44 (0)1453 829 671

Email: instrumentation@gb.abb.com

ABB Inc.**Measurement & Analytics**

125 E. County Line Road
Warminster, PA 18974
USA

Tel: +1 215 674 6000

Fax: +1 215 674 7183

abb.com/measurement

We reserve the right to make technical changes or modify the contents of this document without prior notice. With regard to purchase orders, the agreed particulars shall prevail. ABB does not accept any responsibility whatsoever for potential errors or possible lack of information in this document.

We reserve all rights in this document and in the subject matter and illustrations contained therein. Any reproduction, disclosure to third parties or utilization of its contents – in whole or in parts – is forbidden without prior written consent of ABB.