

JBR Series 30 and 60 Amp Switched Receptacles

Dead Front Interlocked Construction; 600 Volts AC, 50-400 Hertz; Pressure Wire Terminals

NEC:

Class I, Division 1 and 2, Groups B, C, D

Class II, Division 1 and 2, Groups F, G

Class III

NEMA 3⁺, 3R⁺, 4[▼], 4X[▼], 7BCD, 9FG

Applications

- Locations where receptacles are used with stationary or portable electrically operated devices such as:
 - Lighting systems
 - Conveyors
 - Heaters
 - Motor-generator sets
 - Air conditioners
 - Compressors
 - Pumps

Features

- Plug must be inserted into receptacle before the switch is in the on position.
- JBR is UL Listed for use with ACP Powertite™ and CPH plugs.
- Receptacle supplied with flip cover and screw cover.
- Positive polarization: only plugs of the same style, number of poles and amperage rating may be used with these receptacles.
- Terminal block provided in mounting box for ease of wiring. Factory wired between the receptacle and terminal block.
- Style 2 (shell and extra pole) grounding.
- Receptacles may be locked in the "OFF" position.
- Mounting box provided 1-1/2" vertical feed-thru conduit openings. Reducer bushings provided for 1-1/4" conduit opening. All conduit openings have NPT threads.
- O-ring gasket provided between the mounting box and receptacle cover.
- Internal switch provides safe and quick disconnect means. No need for separate disconnect switch.
- UL Classified for use with competitors like plugs ①.

Standard Materials

- Receptacle housing and mounting box: copperfree (4/10 of 1% max.) aluminum
- Captive cover bolts, mounting feet and hinges: stainless steel

Standard Finishes

- Receptacle and mounting box: epoxy powder coat

Options

- For field installed drain and breather set, order one **ECD50B4X** drain and one **BRTB4X** breather. Both are NEMA 4X rated for Group B.
- Special Polarization: Prevents plug insertion in a receptacle or connector wired for a different voltage. In installations where there are different line voltages, the special polarization option is desirable. This allows only plugs and receptacles wired for the same line voltage to be mated together. The receptacle or connector interior is positioned 22-1/2°, relative to the polarization rivet, to the right (as specified) of standard, and plug is polarized to correspond. Suffix **-P4** to receptacle or plug.

NEC Certifications and Compliances

- UL Standard: UL 1010 (UL 1203), UL 894, UL 1682, UL 1686
- UL Listed: E10784

• Flip cover suitable for NEMA 3, 3R only.

▼ NEMA 4 rating maintained with Appleton NEMA 4 plug installed. Install screw cover for 4, 4X. Both covers are included with product.

① UL Classified for use with Crouse-Hinds APJ series plug. Crouse-Hinds is a registered trademark of Cooper Crouse-Hinds.



Illustrated Features

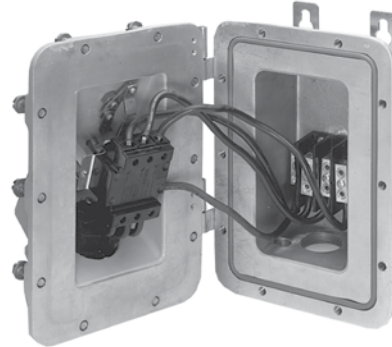

- **Terminal block** provided for line connections.
- **Terminal** provided for grounding connection.
- **Receptacle** is prewired to the terminal block.
- **Disconnect switch** mounted on the cover assembly.

APPLETON™

PLUGS AND RECEPTACLES: NEC/CEC HAZARDOUS LOCATION

JBR Series 30 and 60 Amp Series Switched Receptacles

Dead Front Interlocked Construction

30 and 60 Amp, 600 Vac, 50-400 Hz

NEC:

Class I, Division 1 and 2, Groups B, C, D

Class II, Division 1 and 2, Groups F, G

Class III

NEMA 3•, 3R•, 4▼, 4X▼, 7BCD, 9FG

	Amp	Hub Size (Inches) ①	Wire/Poles	Terminal Block Wire Range	Receptacle Catalog Number	Mating Plug Powertite	Mating Plug CPH ②
	30	1-1/2	2W, 3P	#10 - #4	JBR3023-150	ACP3023BC	CPH3023BC
		1-1/2	3W, 4P	CU-AL	JBR3034-150	ACP3034BC	CPH3034BC
	60	1-1/2	2W, 3P	#4 - #6	JBR6023-150	ACP6023BC	CPH6023BC
		1-1/2	3W, 4P	CU-AL	JBR6034-150	ACP6034BC	CPH6034BC

Accessories

Description	Catalog Number
Type 4X Drain (field installed)	ECD50B4X
Type 4X Breather (field installed)	BRTB4X

Replacement Parts

Description	Catalog Number
30 Amp, 2W, 3P Interlock Rod Assembly	DEJS30
30 Amp, 3W, 4P Interlock Rod Assembly	DEJS30
60 Amp, 2W, 3P Interlock Rod Assembly	DEJS60A
60 Amp, 3W, 4P Interlock Rod Assembly	DEJS60B
100 Amp, 2W, 3P Interlock Rod Assembly	DEJS100A
100 Amp, 3W, 4P Interlock Rod Assembly	DEJS100B
30 Amp, 2W, 3P Receptacle Interior	EBRI3023
30 Amp, 3W, 4P Receptacle Interior	EBRI3034
60 Amp, 2W, 3P Receptacle Interior	EBRI6023
60 Amp, 3W, 4P Receptacle Interior	EBRI6034
100 Amp, 2W, 3P Receptacle Interior	EBRI1023
100 Amp, 3W, 4P Receptacle Interior	EBRI1034
150 Amp, 3W, 4P Receptacle Interior	EBRI15034
30 Amp Plug Clamping Ring (standard with 30 Amp models)	30CRING
30 Amp Screw Cover (for receptacle)	30SCAP

Maximum Horsepower Ratings of Switch

Phase Motor	Amp	Motor Horsepower		
		240 Vac	480 Vac	600 Vac
1-Phase, 2W, 3P	30	7.5	15	20
	60	10	15	20
3-Phase, 3W, 4P	30	7.5	15	20
	60	10	25	30

• Flip cover suitable for NEMA 3, 3R only.

▼ NEMA 4 rating maintained with Appleton NEMA 4 plug installed. Install screw cover for 4, 4X. Both covers are included with product.

① Supplied with (2) 1-1/2" to 1-1/4" reducing bushings.

② 60 Amp CPH plugs with -BC suffix are NOT UL listed.

JBR Series 30 and 60 Amp Switched Receptacles

NEC:

Class I, Division 1 and 2, Groups B, C, D
 Class II, Division 1 and 2, Groups F, G
 Class III
 NEMA 3[•], 3R[•], 4[▼], 4X[▼], 7BCD, 9FG

ACP Plugs for JBR Receptacles

Cable Dia. (Inches)	30 Amp		60 Amp	
	2W, 3P	3W, 4P	2W, 3P	3W, 4P
 .390 to 1.375	ACP3023BC	ACP3034BC	ACP6023BC	ACP6034BC

CPH Plugs for JBR Receptacles

Cable Dia. (Inches)	30 Amp		60 Amp ①	
	2W, 3P	3W, 4P	2W, 3P	3W, 4P
 .390 to 1.375	CPH3023BC	CPH3034BC	CPH6023BC	CPH6034BC

Dimensions in Millimeters (Inches)

ACP Plugs

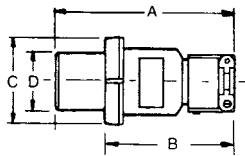

Max. Amp	No. Poles	Dimensions in Millimeters (Inches)			
		A	B	C	D
30	2,3,4	152.4 (6.00)	120.6 (4.75)	79.5 (3.13)	47.2 (1.86)
60	2,3	198.3 (7.81)	125.4 (4.94)	88.9 (3.50)	56.6 (2.23)
60	4	198.3 (7.81)	125.4 (4.94)	96.7 (3.81)	64.7 (2.55)

CPH Plugs

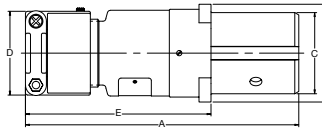

Max. Amp	Wire/Pole	Dimensions in Millimeters (Inches)				
		A	B	C	D	E
30	2W, 3P; 3W, 4P	155.7 (6.13)	60.4 (2.38)	47.2 (1.86)	6.68 (2.63)	112.7 (4.44)
60	2W, 3P	214.3 (8.44)	77.7 (3.06)	77.7 (3.06)	6.68 (2.63)	144.5 (5.69)
60	3W, 4P	214.3 (8.44)	77.7 (3.06)	64.7 (2.55)	6.68 (2.63)	144.5 (5.69)

• Flip cover suitable for NEMA 3, 3R only.

▼ NEMA 4 rating maintained with Appleton NEMA 4 plug installed. Install screw cover for 4, 4X. Both covers are included with product.

① 60 Amp CPH plugs with -BC suffix are NOT UL listed.

JBR Series 30 and 60 Amp Switched Receptacles

NEC:
 Class I, Division 1 and 2, Groups B, C, D
 Class II, Division 1 and 2, Groups F, G
 Class III
 NEMA 3•, 3R•, 4▼, 4X▼, 7BCD, 9FG

Dimensions in Millimeters (Inches)

Shown with Flip Cover

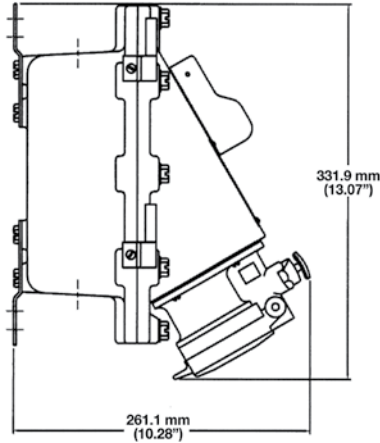

Drilling Plans for Mounting Bolts

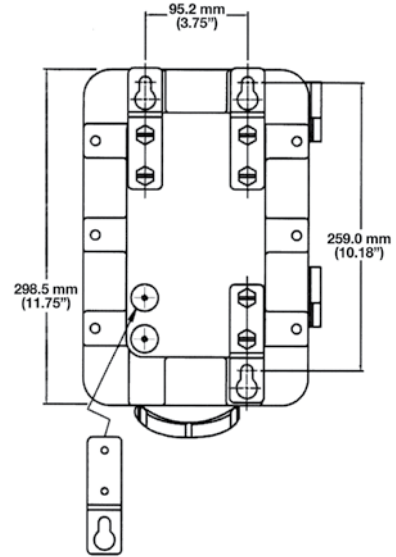

Top View

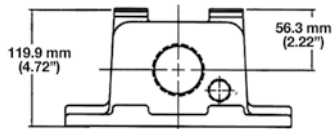

Bottom View

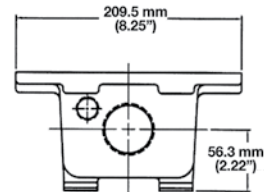

APPLETON™

PLUGS AND RECEPTACLES: NEC/CEC HAZARDOUS LOCATION

• Flip cover suitable for NEMA 3, 3R only.
 ▼ NEMA 4 rating maintained with Appleton NEMA 4 plug installed. Install screw cover for 4, 4X. Both covers are included with product.