

EasyLine EL3000

Continuous gas analyzers



So smart, they're simple

Measurement made easy

—
EasyLine EL3020
EasyLine EL3040

Introduction

EasyLine is a powerful yet cost-effective line of devices for the measurement of gas concentrations in numerous applications.

Automatic calibration and the use of superior ABB calibration cell technology in the photometer avoids the use of expensive test gas cylinders in most applications.

Zero-point calibration with ambient air

Various analyzer types available:
Combining different analyzers in a single housing enables optimum economy and operational efficiency for your application.

Additional Information

Additional documentation on EasyLine EL3000 is available for download free of charge at www.abb.com/analytical.

Alternatively simply scan this code:



Table of contents

1	Safety	3	5	Electrical connections	90
	General information and instructions.....	3		Safety instructions	90
	Warnings.....	3		General Notes.....	90
	Intended use	4		Model EL3020	90
	Improper use.....	4		Model EL3040.....	91
	Safety instructions.....	5		Analog output modules	93
	Fidas24 – Information for safe operation.....	6		Digital I/O module.....	94
	Notes on data safety	7		Modbus®-Module.....	96
	Manufacturer’s address.....	8		PROFIBUS®-Module	96
	Service address.....	8		Connecting the Signal Lines	97
				Connecting the power supply	97
2	Use in potentially explosive atmospheres	9	6	Commissioning	99
	Notes on use in potentially explosive atmospheres.....	9		Safety instructions	99
	Explosion proof design in degree of protection II 3G	10		Installation Check	99
3	Preparation for Installation	12		Purge sample gas path and analyzer housing.....	100
	Scope of delivery	12		Gas analyzer start-up.....	100
	Material required for installation	12		Fidas24 – Standby / Restart	104
	Requirements for the installation site	14		Checking gas path leak tightness	105
	Power supply.....	15		Check the integrity of combustion gas path.....	105
	Uras26	16		Important instructions for measuring	
	Limas23	18		combustion gases	107
	Magnos206.....	20		Important instructions for explosion-proof design in	
	Magnos28	22		degree of protection II 3G.....	107
	Magnos27	24		Failure of instrument air supply.....	108
	ZO23	25	7	Operation	109
	Caldos27.....	28		Safety instructions	109
	Fidas24.....	30		LCD indicator.....	109
	Sample gas input and output conditions	32		Menu Overview	113
	Pressure sensor	33		Notes on the operating concept.....	113
	Housing purge	33		Communication between gas analyzer and computer	114
	Dimensions.....	35	8	Maintenance	117
	Special conditions for the measurement of combustion			Safety instructions	117
	gases	38	9	Decommissioning	117
4	Installation	40		Decommissioning the gas analyzer.....	117
	Unpacking the Gas Analyzer.....	40		Fidas24 – Shutting down the gas analyzer	118
	Name plate	40		Packing the Gas Analyzer	118
	Analyzer data sheet.....	40		Returning devices	119
	Mounting the fittings on the gas analyzer	41	10	Recycling and disposal	119
	Position and design of the gas connections.....	42	11	Specification	120
	Gas Analyzer Installation.....	82	12	Additional documents	120
	Connecting the gas lines	83	13	Appendix	121
	Fidas24 – Connect gas lines	84		Return form.....	121
	Fidas24 – Connecting the combustion gas line.....	85			
	Fidas24 – Connecting the sample gas line to the heated				
	sample gas connection	86			
	Fidas24 – Connecting the sample gas line to the				
	unheated sample gas connection.....	88			

1 Safety

General information and instructions

These instructions are an important part of the product and must be retained for future reference.

Installation, commissioning, and maintenance of the product may only be performed by trained specialist personnel who have been authorized by the plant operator accordingly. The specialist personnel must have read and understood the manual and must comply with its instructions.

For additional information or if specific problems occur that are not discussed in these instructions, contact the manufacturer.

The content of these instructions is neither part of nor an amendment to any previous or existing agreement, promise or legal relationship.

Modifications and repairs to the product may only be performed if expressly permitted by these instructions.

Information and symbols on the product must be observed.

These may not be removed and must be fully legible at all times.

The operating company must strictly observe the applicable national regulations relating to the installation, function testing, repair and maintenance of electrical products.

This commissioning instruction (CI) contains all information on safe device commissioning and operation.

Detailed information on calibration, configuration, diagnosis and maintenance is provided in the related operating instruction (OI).

Warnings

The warnings in these instructions are structured as follows:

DANGER

The signal word '**DANGER**' indicates an imminent danger. Failure to observe this information will result in death or severe injury.

WARNING

The signal word '**WARNING**' indicates an imminent danger. Failure to observe this information may result in death or severe injury.

CAUTION

The signal word '**CAUTION**' indicates an imminent danger. Failure to observe this information may result in minor or moderate injury.

NOTICE

The signal word '**NOTICE**' indicates possible material damage.

Note

'**Note**' indicates useful or important information about the product.

... 1 Safety

Intended use

The gas analyzer is designed for continuous measurement of the concentration of individual components in gases or vapors.

Any other use is not approved.

The intended use also includes taking note of this operating instruction.

Note

The version for the measurement of flammable gases and the explosion-proof design in degree of protection II 3G is designed for various variants of the gas analyzer and for different applications.

Measurement of flammable gases

DANGER

Explosion hazard

Explosion hazard when operating the gas analyzer in potentially explosive atmospheres.

- Only operate the gas analyzer in the version with stainless steel gas lines and gas connections (models EL3020 and EL3040), for the measurement of flammable gases and vapors, outside hazardous areas.

Observe the following information when measuring flammable gases*:

- The gas analyzer may only be used for the measurement of non-incendive gas / air or gas / oxygen mixtures.
- The special conditions for the measurement of flammable gases (see **Special conditions for the model EL3020 gas analyzer for the measurement of flammable gases** on page 14) must be observed.
- The oxygen sensor, as well as the assemblies of the integral gas feed (option "Integrated gas feed option – only in model EL3020, not for Limas23, ZO23, Fidas24) may not be used for the measurement of flammable gases.

* A flammable gas is a gas that can be ignited by adding air.

Operation in hazardous areas

DANGER

Explosion hazard

Explosion hazard when measuring flammable gases in hazardous areas.

- The gas analyzer in the explosion-proof design (model EL3040) may only be used for the measurement of **non-flammable** gases and vapors.

The model EL3040 gas analyzer is available in explosion-proof design with degree of protection II 3G (see **Use in potentially explosive atmospheres** on page 9).

Important safety instructions

In accordance with the EU Directive 2014/34/EU and the general requirements for explosion protection and as specified in the IEC 60079-0 standard, the scope of approvals for our explosion-protected device is limited to atmospheric conditions, unless expressly stated otherwise in the certificates.

The **atmospheric conditions** are defined as follows:

Temperature	-20 to 60 °C
Pressure p_{abs}	80 to 110 kPa (0.8 to 1.1 bar)
Ambient air with a normal oxygen content, typically 21% Vol.-%	

If the **atmospheric conditions are not complied** with, the operator is obliged to ensure the safe operation of our devices in the absence of the recommended atmospheric conditions, by means of further measures (e.g. evaluation of the gas mixture) and/or supplementary protective devices.

Improper use

The following are considered to be instances of especially improper use of the device:

- For use as a climbing aid, for example for mounting purposes.
- For use as a bracket for external loads, for example as a support for piping, etc.
- Material application, for example by painting over the housing, name plate or welding/soldering on parts.
- Material removal, for example by spot drilling the housing.

Safety instructions

Requirements for safe operation

In order to operate in a safe and efficient manner the device should be properly handled and stored, correctly installed and set-up, properly operated and correctly maintained.

Personnel qualifications

Only persons familiar with the installation, set-up, operation and maintenance of comparable devices and certified as being capable of such work should work on the device.

Special information and precautions

These include:

- The content of this operating instruction,
- The safety information affixed to the device,
- The applicable safety precautions for installing and operating electrical devices,
- Safety precautions for working with gases, acids, condensates, etc.

National regulations

The regulations, standards and guidelines cited in this operator's manual are applicable in the Federal Republic of Germany. The applicable national regulations should be followed when the device is used in other countries.

Safety of the equipment and safe operation

The device was built and tested in accordance with EN 61010 Part 1 'Safety regulations for electrical measuring, control and laboratory equipment' and it left the factory in perfect condition.

To maintain this condition and to assure safe operation, read and follow the safety instructions in this operating instruction. Failure to do so can put persons at risk and can lead to device damage as well as damage to other systems and devices.

Protective lead connection

The protective lead (ground) should be attached to the protective lead connector before any other connection is made.

Risks of a disconnected protective lead

The device can be hazardous if the protective lead is interrupted inside or outside the device or if the protective lead is disconnected.

Risks involved in opening the covers

Current-bearing components can be exposed when the covers or parts are removed, even if this can be done without tools. Current can be present at some connection points.

Risks involved in working with an open device

All work on a device that is open and connected to power should only be performed by trained personnel who are familiar with the risks involved.

When safe operation can no longer be assured

If it is apparent that safe operation is no longer possible, the device should be taken out of operation and secured against unauthorized use.

The possibility of safe operation is excluded:

- If the device is visibly damaged,
- If the device no longer operates,
- After prolonged storage under adverse conditions,
- After severe transport stresses.

... 1 Safety

Fidas24 – Information for safe operation

DANGER

Explosion hazard

Explosion hazard due to leaking combustion gas (hydrogen).

- All the information and instructions contained in this Commissioning Instruction must be complied with without fail to guarantee safe operation of the gas analyzer!

Measures of the manufacturer

The following measures ensure that the enrichment of combustion gas or an explosive mixture of combustion gas and ambient air cannot occur inside the gas analyzer during normal operation:

- The tightness of the combustion gas feed path is checked for a leakage rate of $< 1 \times 10^{-4}$ hPa·l/s before delivery.
- The combustion gas/air mixture (before and after the ignition point) is diluted in the detector with compressed air.
- The combustion gas feed is not connected to the supply during commissioning until the internal nominal pressures have been set.
- The combustion gas feed is switched off if the internal nominal pressures cannot be set during the ignition phase (e.g. because of insufficient compressed air or combustion air feed).
- The combustion gas feed is switched off after several unsuccessful ignition attempts.
- If the flame goes out during operation, the combustion gas feed is switched off if the following ignition attempts are unsuccessful.

The interior of the gas analyzer cannot be allocated to an (explosion protection-) zone; an explosive gas mixture cannot escape to the outside.

Conditions to be complied with by the end user

The end user must comply with the following prerequisites and conditions to ensure safe operation of the gas analyzer:

- The gas analyzer may be used for the measurement of flammable gases provided that the flammable portion does not up-scale 15 Vol.-% CH₄ oder C1 equivalents.
- The relevant safety regulations for working with combustion gases must be complied with.
- The gas connection diagram (see **Gas connections and electrical connections Fidas24 (model EL3020)** on page 80 and **Gas connections and electrical connections Fidas24 (model EL3040)** on page 81) must be complied with when connecting the combustion gas and combustion air.
- The combustion gas path in the gas analyzer must not be opened! The combustion gas path can become leaky as a result! Escaping combustion gas can cause fires and explosions, also outside the gas analyzer!
- If the combustion gas path in the gas analyzer has been opened nonetheless, it must be checked for leakage (refer to **Check the integrity of combustion gas path** on page 105), using a leak detector (leak rate $< 1 \times 10^{-4}$ hPa l/s), once it has been closed again.
- The tightness of the combustion gas supply line (see **Combustion gas line** on page 105) outside the gas analyzer as well as the combustion gas path (see **Combustion gas path in the gas analyzer** on page 106) in the gas analyzer must be checked regularly.
- The maximum pressures of combustion gas and combustion air (see **Operational gases** on page 30) may not be up-scaled.
- The maximum combustion gas flow (see **Combustion gas parameter** on page 31) may not be up-scaled.

- The combustion gas flow rate must be limited to a maximum of 10 l/h H₂ or 25 l/h H₂/He mixture. Suited measures (see **Combustion gas parameter** on page 31) outside the gas analyzer must be provided by the operator for this purpose.
- In order to increase the safety level under the following operational conditions, a shut-off valve (refer to **Combustion gas parameter** on page 31) must be installed in the combustion gas supply line:
 - when shutting down the gas analyzer,
 - in case of instrument air supply failure,
 - in case of a leak in the combustion gas path, inside the gas analyzer.

This shut-off valve should be installed outside the analyzer house in the vicinity of the combustion gas supply (cylinder, line).

- Should the combustion gas supply to the analyzer module not shut off automatically in the event of an instrument air supply failure, an alarm that is visible or audible to the operator must be triggered (refer to **Failure of instrument air supply** on page 108).
- When measuring combustion gases, it must be ensured that if either the instrument air supply or the analyzer module should fail, the sample gas supply to the analyzer module will be shut off and the sample gas path purged with nitrogen.
- The unobstructed exchange of air with the environment must be possible around the gas analyzer. The gas analyzer must not be directly covered. The openings in the housing towards the top and at the side may not be closed. The distance to laterally adjacent built-in components must be at least 4 mm.
- If the gas analyzer is installed in a closed cabinet, adequate ventilation of the cabinet must be provided (at least 1 change of air per hour). The distance to adjacent built-in components towards the top and at the side must be at least 4 mm.

Notes on data safety

This product is designed to be connected to a network interface and to communicate information and data via this network interface.

It is the operator's sole responsibility to provide and continuously ensure a secure connection between the product and your network or any other network (as the case may be).

The operator must implement and uphold appropriate measures (such as the installation of firewalls, the application of authentication measures, data encryption, the installation of anti-virus programs, etc.), in order to protect the product, the network, the connected systems and the interface from any breaches of security, unauthorized access, interference, intrusion, loss and/or theft of data or information.

ABB Automation GmbH and its subsidiaries do not accept liability for any damage and/or loss resulting from such breaches of security, unauthorized access, interference, intrusion or loss and/or theft of data or information.

Services and ports on the Ethernet interface

Port	Description
22/tcp	Used only for software updates. No direct access to the device.
502/tcp	Used for Modbus/TCP. The device allows connection to any Modbus client. The port must be activated via ECT, the port is delivered in a deactivated state.
8100/tcp	Used for test and calibration software Optima TCT Light. Binary proprietary protocol. The port is deactivated. It can be activated for TCT access via a secure connection, and deactivated when the TCT access is terminated

... 1 Safety

... Notes on data safety

Access authorizations

Access to both the calibration functions and those functions used to change the instrument configuration can be restricted by means of password protection.

The password protection is not activated at the factory (except in the case of gas analyzers used for emission monitoring).

It is recommended that the factory-set passwords be changed by the operator, by means of the ECT software tool ("EasyLine Configuration Tool") (**Password protection** on page 111). This limits access to both the ECT software tool itself and to the calibration and configuration functions of the device.

Manufacturer's address

ABB Automation GmbH

Measurement & Analytics

Stierstädter Str. 5

60488 Frankfurt am Main

Germany

Tel: +49 69 7930-4666

Email: cga@de.abb.com

Service address

If the information in this Commissioning Instruction does not cover a particular situation, ABB Service will be pleased to supply additional information as required.

Please contact your local service representative.

For emergencies, please contact:

Customer service center

Tel: +49 180 5 222 580

Email: automation.service@de.abb.com

2 Use in potentially explosive atmospheres

Notes on use in potentially explosive atmospheres

Installation in accordance with IEC/EN 60079-14 (VDE 0165 Part 1)

The electric equipment must be installed in potentially explosive atmospheres in accordance with IEC/EN 60079-14 (VDE 0165 Part 1) "Electric Equipment for Hazardous Gas Areas, Part 14: Electric Systems in Potentially Explosive Atmospheres."

Potential equalization

With regard to potential equalization, the provisions of IEC/EN 60079-14 as well as DIN VDE 0100 Part 410 "Protection against electric shocks" and Part 540 "Grounding, Protective ground, Potential equalization conductors" must be observed.

Electrostatic charges

Electrostatic charges must be avoided. The professional association rules for the "Prevention of ignition hazards due to electrostatic charges (BGR 132) must be observed here.

Monitoring and review

Electric systems in potentially explosive atmospheres must be monitored for proper condition.

As necessary, but at least every three years, they must be inspected by an electrician, provided they are not constantly monitored under the supervision of a responsible engineer.

Work on electric systems

Before any maintenance work is carried out on electric installations in potentially explosive atmospheres, the installations must be disconnected from the power supply. The disconnect point must be identified with an appropriate warning sign, for example, "Do not power-up – explosion hazard" This does not apply to devices that may be opened as part of normal operation, such as registration devices, or for which it is expressly noted in the type examination certificate.

Maintenance work on the device where opening the housing or part of the housing is necessary is only permitted in a non-hazardous atmosphere.

Opening the device when an explosive atmosphere is present is not permitted! (Explosion hazard)

Work on intrinsically safe circuits

Work on live systems may be carried out on intrinsically safe circuits even in potentially explosive atmospheres. However, the electric data (inductance, capacity, current and voltage values) of the corresponding test equipment must be observed during power-up. Special attention is required when carrying out work on intrinsically safe circuits that have been set up in connection with zone 0

Explosion hazard

Before repairs, the explosion hazard must have been eliminated.

Competent personnel

Repair work may only be performed by competent personnel.

Original spare parts

Only original spare parts may be used for repairs.

Inspection prior to recommissioning

If repair work is carried out on parts of electric equipment on which explosion protection depends, a specialist needs to inspect and certify before recommissioning that the attributes of the equipment in terms of design and version which are essential for explosion protection match the equipment described in the declaration.

Repairs by the manufacturer

Repairs can also be carried out by the manufacturer, for example on-site by an ABB Service employee or at the manufacturing plant.

In this case, a marking showing the performed repairs with subsequent routine testing is affixed to the name plate. Testing by a specialist is not required then.

... 2 Use in potentially explosive atmospheres

Explosion proof design in degree of protection II 3G

Note

The version for the measurement of flammable gases and the explosion-proof design in degree of protection II 3G is designed for various variants of the gas analyzer and for different applications.

Description

The model EL3040 gas analyzer in degree of protection II 3G is tested for explosion protection and is suited for use in potentially explosive atmospheres, with consideration of the specification and the special conditions (see **Special conditions** on page 11).

The gas analyzer is intended for indoor installation only.

In the gas analyzer, the Uras26, Magnos206, Magnos28 and Caldos27 analyzers can be installed individually and in these combinations: Uras26 with Magnos206 or Magnos28 or Caldos27 or oxygen sensor.

The gas analyzer may be used for measurement of **non-flammable** gases and vapors.

The gas analyzer is marked in accordance with the European directive 2014/34/EU as:

 II 3G Ex ec nC IIC T4 Gc

In undisturbed operation there cannot be any sparking, arcing or impermissible temperatures inside the device.

Explosion protection through: increased safety as well as gasketed or encapsulated equipment.

Type examination certificate no. BVS 16 ATEX E 085 X.

Note

The measurement function of the analyzer is not part of the type examination certificate.

Characteristic values

System bus, computer interfaces

Supply voltage	100 to 240 V AC
Power consumption	Maximum 187 VA

Pneumatic data

Purge gas

Inlet pressure	Maximum 1104 hPa
----------------	------------------

Measured gas

Non-flammable sample gas

Inlet pressure	Magnos28:
	Maximum 1600 hPa absolute pressure
	All other analyzer modules:
	Maximum 1100 hPa absolute pressure or maximum 100 hPa gauge pressure

Flow rate (gas output atmospheric)	Maximum 100 l/h
------------------------------------	-----------------

Temperature data

Ambient temperature	5 to 45 °C (41 to 113 °F)
---------------------	---------------------------

Special conditions

- The cables must be inserted into the cable glands properly and gasketed by tightening the screws so that the IP 65 housing protection is maintained.
Unused cable glands must be sealed with suited sealing plugs, so that the IP 65 housing protection is guaranteed here as well.
- During operation, the unused purge gas connections must be sealed with sealing plugs.
- If there is an explosion hazard at the installation site of the gas analyzer, the housing must not be opened when live and the connectors must not be disconnected when live.
- Due to the low mechanical stability of the viewing glass, the gas analyzer must be designed and operated in such a way that mechanical damage to the viewing glass with an energy greater than 2 J can be excluded. If the viewing glass becomes nevertheless damaged to the point that the IP 65 housing protection is no longer met, the gas analyzer must be decommissioned, secured against recommissioning and repaired.
- Due to the low UV resistance of the plastic parts of the housing, the gas analyzer must be designed and operated in such a way that the effect of UV radiation can be excluded. If the housing is nevertheless damaged by UV radiation to the point that the housing protection IP 65 is no longer maintained, the gas analyzer must decommissioned, secured against recommissioning and repaired.

Replacing the battery

- The battery may only be replaced in a non-hazardous atmosphere.
- Only the original battery may be used as a spare: lithium button cell 3 V type Varta CR2032.

3 Preparation for Installation

Scope of delivery

- Gas analyzer model EL3020 (19" housing) or model EL3040 (wall housing)
- Screwed fittings with tubing connectors for the connection of flexible tubes
- Power cable, length 5 m, see **Connecting the power supply** on page 97.
- Counter plug (socket housing) for the electrical connection of the I/O modules (plugged into the I/O module connections)
- Screwdriver (required for attaching the electric lines in the counter plugs)
- Fine filtration (pre-assembled), see **Installing the fine filter** on page 83.
- Commissioning Instruction
- Analyzer data sheet

Fidas24

- Power cable, length 5 m, with 4-pin female connector and separate grounding connector for the power supply to the detector heating and the heated sample gas connection. Refer to **Connecting the power supply** on page 97.
- Accessory bag with fittings and O-rings for the connection of the sample gas lines
- Exhaust air pipe with connecting nut and locking ring

Commissioning Instruction

The gas analyzer is delivered with a commissioning manual.

The commissioning instruction is an extract from the operating instruction, and it contains all the information required to install, commission and operate the gas analyzer safely, for its intended purpose.

The commissioning manual does not contain information regarding calibration, configuration and maintenance of the gas analyzer or about the Modbus® and PROFIBUS® interface.

Analyzer data sheet

The design of the gas analyzer that has been supplied is documented in detail in the analyzer data sheet.

Material required for installation

Note

The materials listed below are not included in the scope of delivery of the device, and must be provided by the customer.

Gas connections

For the connection of piping:

Threaded connections with 1/8" NPT thread and PTFE sealing tape.

Fidas24: Gas lines

Process gases, test gases and waste air

- PTFE or stainless steel tubes with 4 mm inside diameter and PTFE or stainless steel tube with min. 10 mm inside diameter for waste air
- Tube fittings
- Pressure regulator
- Flow restrictors in the combustion gas supply line, see **Flow restrictor in the combustion gas supply line** on page 31.
- Shut-off valve in the combustion gas supply line, see **Shut-off valve in the combustion gas supply line** on page 31.

Sample gas

Heated sample gas line (recommended: TBL 01) or unheated sample gas line (PTFE or stainless steel tube with inside/outside diameter 4/6 mm).

The fittings and O-rings required for the connection are included within the scope of delivery of the gas analyzer.

Flowmeter/flow controller

Flowmeters or flow controllers with needle valve for setting and monitoring the sample gas flow as well as purge gas flow, if necessary.

Information for the selection and use of flowmeters:

- Measuring range 7 to 70 l/h
- Pressure drop < 4 hPa
- Needle valve open

Recommendation:

Flowmeter 7 to 70 l/h,
Order number 23151-5-8018474

Shut-off valve

Install a shut-off valve in the sample gas line (recommended when the sample gas is pressurized).

Purging of the gas line system

Plan for the option of connecting an inert gas, such as nitrogen, from the gas sampling point for purging the gas line system.

Installation Material**19" housing (model EL3020)**

- 4 raised head screws
(recommendation: M6; this depends on the cabinet/ rack system)
- 1 pair mounting rails (design depending on the cabinet/ frame system), length approx. 240 mm corresponding to approx. $\frac{2}{3}$ the housing depth

Wall-mount housing (model EL3040)

4 M8 or M10 screws

Signal Lines

Select conductive material which is appropriate for the length of the lines and the predictable current load.

Notes concerning the cable cross-section for connection of the I/O modules:

- The maximum capacity of terminals for stranded or solid conductors is 1 mm² (17 AWG).
- The stranded conductor may be tinned on the tip or twisted for simplified connection.
- When using wire end ferrules the total section must not exceed 1 mm², i.e. the maximum stranded conductor section cannot be greater than 0.5 mm². The Weidmüller PZ 6/5 crimping tool must be used for crimping the ferrules.

Lengths and types of cables for the RS485 lines

- Maximum 1,200 m (transfer rate, maximum 19,200 bit/s).
- Three-core twisted-pair cable, conductor cross section 0.25 mm² (e.g. order number 746620)

Length of the RS232 lines

Maximum 15 m.

Mating connector (socket housing)

The required mating connector (socket housing) for the plug-in terminal strips on the I/O modules is included in the scope of delivery.

Power supply lines

- If the supplied power cable is not used, select conductive material which is appropriate for the length of the lines and the predictable current load.
- Provide a supply circuit isolator or a switched socket outlet to be able to disconnect the power supply at all phases from the gas analyzer if required.

... 3 Preparation for Installation

Requirements for the installation site

Note

For the analyzers ZO23 and Fidas24, the instructions specified in **ZO23** on page 25 or **Fidas24** on page 30 must be observed.

Installation site requirements

The gas analyzer is intended for indoor installation only.

The specification of the gas analyzer (see data sheet) is applicable up to a height of 2000 m above sea level. Altitude above 2000 m on request.

The installation site must be stable enough to bear the weight of the gas analyzer!

For safe installation and disassembly, we recommend supporting the 19" housing in the cabinet or rack with slide rails!

Short gas paths

Install the gas analyzer as close as possible to the sampling location.

Install the gas conditioning and calibration modules as close as possible to the gas analyzer.

Adequate air circulation

Provide for adequate natural air circulation around the gas analyzer. Avoid heat build-up.

Mount several 19" housings with a minimum distance of 1 HE between each housing, see **Gas Analyzer Installation** on page 82.

Protection from adverse ambient conditions

Protect the gas analyzer from the following influences:

- Cold,
- Exposure to heat from e.g. the sun, furnaces, boilers,
- Temperature variations,
- Strong air currents,
- Accumulation of dust and ingress of dust,
- Corrosive atmosphere,
- Vibration.

Climatic Conditions

Relative humidity

Maximum 75 %, no condensation

Ambient temperature

- During operation:
5 to 45 °C
- Uras26 in combination with another analyzer, Limas23, Fidas24:
5 to 40 °C

Transport-/Storage temperature

-25 to 65 °C

Housing protection (IP rating)

Model EL3020 (19" housing)

IP 20, IP 40 (with version for emissions measurement)

Model EL3040 (wall-mounted enclosure)

IP 65

Special conditions for the model EL3020 gas analyzer for the measurement of flammable gases

Unrestricted exchange of air with the environment must be provided around the gas analyzer from the bottom (floor plate) and from the rear (gas connections).

The gas analyzer may not be placed directly on a table.

The housing openings may not be closed. Spacing to adjacent built-in components to the sides must be at least 3 cm.

If the gas analyzer is installed in a closed cabinet, adequate ventilation of the cabinet must be provided (at least 1 change of air per hour).

The spacing to adjoining fittings from the bottom (floor plate) and from the back (gas connections) must be at least 3 cm.

Special conditions for the model EL3040 gas analyzer in degree of protection II 3G

Protection against mechanical influences

Due to the low mechanical stability of the viewing glass, the gas analyzer must be designed and operated in such a way that mechanical damage to the viewing glass is excluded with an energy greater than 2 J.

UV radiation protection

Due to the low UV resistance of the plastic parts of the housing, the gas analyzer must be designed and operated in such a way that the effect of UV radiation can be excluded.

Housing design

Model	Housing design	IP rating	Weight
EL3020	19" housing	IP 20	approx. 7 to 15 kg
EL3040	Wall-mount housing	IP 65	approx. 13 to 21 kg

Power supply

Electric information (entire device)

The power supply built into the system housing is used to supply 24 V DC to the analyzer module and the associated electronics.

Input voltage

100 to 240 V AC, -15/+10 %;
50 to 60 Hz, ± 3 Hz

Power

Maximum 187 VA (without heaters from Fidas24)

Connection

3-pole cold device plug in accordance with EN 60320-1/C14
(Power cable included in scope of supply)

Battery

Lithium 3 V type Varta CR2032 button cell, to supply the integrated clock during a voltage drop

Electric information (analyzer modules)

Input voltage

24 V DC, ± 5 %

Power consumption analyzer modules (DC)

Uras26:	Max. 95 W	Magnos206:	max. 50 W
Limas23:	max. 100 W	ZO23:	max. 35 W
Magnos28:	max. 50 W	Caldos27:	max. 17 W
Magnos27:	max. 35 W	Fidas24:	max. 50 W

Fidas24 Analyzer Module (AC)

Detector and Sample Gas Inlet Heaters

Input voltage	115 V AC or 230 V AC, ± 15 % (max. 250 V AC), 50 to 60 Hz, ± 3 Hz
Power consumption	125 VA for detector 125 VA for sample gas inlet (option)
Connection	4-pin male connector (connection cable included in scope of supply)

... 3 Preparation for Installation

Uras26

Sample gas

Sample gas inlet conditions

DANGER

Explosion hazard

Explosion hazard when measuring ignitable gas / air or gas / oxygen mixtures

- The gas analyzer may not be used for the measurement of ignitable gas / air or gas / oxygen mixtures

Uras26 – sample gas input conditions

Temperature

The sample gas dew point should be at least 5 °C below the temperature throughout the sample gas path. Otherwise a sample gas cooler or condensate trap is required.

Pressure

The analyzer is operated under atmospheric pressure; the sample gas outlet is open to atmosphere.

Internal pressure drop: < 5 hPa at standard flow rate of 60 l/h.

Permissible absolute pressure range: 800 to 1250 hPa.

Operation under lower absolute pressure (e.g. at altitudes above 2000 m) on request.

Gauge pressure in the sample cell: max. 500 hPa.

Flow rate 20 to 100 l/h

Corrosive gases

The analyzer may not be used for measurement in corrosive gases. Associated gases, such as chlorine (Cl₂) or hydrogen chlorides (such as wet HCl) as well as gases or aerosols containing chlorine must be cooled or pre-absorbed.

Flammable gases

In the version with gas lines and gas connectors made of stainless steel, the analyzer is suited for the measurement of flammable gases in non-explosive environments.

The special conditions when measuring flammable gases must be observed, see **Special conditions for the model EL3020 gas analyzer for the measurement of flammable gases** on page 14.

Flowing reference gas

Gas inlet conditions as for sample gas

Pressure sensor

The pressure sensor is installed in the gas analyzer as standard, see **Pressure sensor** on page 33.

The pressure sensor is connected to the sample gas path or a connection socket at different positions depending on the design of the gas analyzer, see **Position and design of the gas connections** on page 42.

The connection of the pressure sensor is also documented in the pneumatic diagram included in the device data sheet.

Gas connections

See **Gas connections Uras26 (model EL3020)** on page 43 and **Gas connections Uras26 (model EL3040)** on page 45.

Test gases – Uras26

Analyzer(s)	Test gas for the zero calibration	Test gas for the end-point calibration
Uras26 with calibration cells (automatic calibration)	N ₂ or air or sample component-free gas	— (calibration cells)
Uras26 without calibration cells (automatic calibration)	N ₂ or air	Span gas*
Uras26 without calibration cells (manual calibration)	N ₂ or air	Test gas for each sample component
Uras26 + Magnos206 / Magnos28 (automatic calibration, i.e. Magnos206 / Magnos28 with single-point calibration)	IR sample component-free test gas with O ₂ concentration in an existing measuring range or ambient air.	Calibration cells or span gas*
Uras26 + Magnos206 / Magnos28 (manual calibration)	Zero reference gas for Uras26 or Magnos206 / Magnos28, or IR sample component-free test gas with O ₂ concentration in an existing measuring range or ambient air.	Span gas for all sample components in the Uras26 and in the Magnos206 / Magnos28 (possibly only for the Uras26 if a single-point calibration is carried out for the Magnos206 / Magnos28)
Uras26 + Magnos27 (automatic calibration)	IR sample component-free test gas with O ₂ concentration in an existing measuring range or ambient air.	Calibration cells or span gas*
Uras26 + Magnos27 (manual calibration)	Zero point gas for Uras26 or Magnos27, or IR sample component-free test gas with O ₂ -concentration in an existing measuring range or ambient air.	Span gas for all sample components in Uras26 and Magnos27
Uras26 + Caldos27 (automatic calibration, i.e. Caldos27 with single-point calibration)	IR sample component-free test gas with a known and constant rTC value (possibly also dried room air)	Calibration cells or span gas*
Uras26 + Caldos27 (manual calibration)	Zero reference gas for Uras26 or Caldos27, or IR sample component-free test gas with a known rTC value	Span gas for all sample components in the Uras26 and Caldos27 (possibly only for the Uras26 if a single-point calibration is carried out for the Caldos27)
Uras26 + oxygen sensor (automatic calibration)	IR sample component-free test gas with O ₂ concentration in an existing measuring range or ambient air.	Calibration cells or span gas*
Uras26 + Oxygen sensor (manual calibration)	IR sample component-free test gas with O ₂ concentration in an existing measuring range or ambient air.	Span gas for all sample components in Uras26

* Test gas mixture for multiple sample components possible if no or negligible cross-sensitivity is present

Dew point

The dew point of the test gases must be approximately equal to the dew point of the sample gas.

Note

The instructions for calibration must be observed, see Operating instruction.

... 3 Preparation for Installation

Limas23

Sample gas

Sample gas inlet conditions

DANGER

Explosion hazard

Explosion hazard when measuring flammable gases and ignitable gas / air or gas / oxygen mixtures

- The gas analyzer must not be used for measurement of flammable gases and ignitable gas / air or gas / oxygen mixtures.

Limas23 – sample gas input conditions

Temperature

- The sample gas dew point should be at least 5 °C below the temperature throughout the sample gas path. Otherwise a sample gas cooler or condensate trap is required.
- The internal temperature of the gas analyzer is at least 10 °C higher than ambient temperature.

Designation of gas connections

The analyzer is operated under atmospheric pressure; the sample gas outlet is open to atmosphere.

Internal pressure drop: < 5 hPa at standard flow rate of 60 l/h.

Permissible absolute pressure range: 800 to 1250 hPa.

Operation under lower absolute pressure (e.g. at altitudes above 2000 m) on request.

Gauge pressure in the sample cell: max. 500 hPa.

Flow rate 20 to 100 l/h

Corrosive gases

The analyzer may not be used for measurement in corrosive gases. Associated gases, such as chlorine (Cl₂) or hydrogen chlorides (such as wet HCl) as well as gases or aerosols containing chlorine must be cooled or pre-absorbed.

Pressure sensor

The pressure sensor is installed in the gas analyzer as standard, see **Pressure sensor** on page 33.

The pressure sensor is connected to the sample gas path or a connection socket at different positions depending on the design of the gas analyzer, see **Position and design of the gas connections** on page 42.

The connection of the pressure sensor is also documented in the pneumatic diagram included in the device data sheet.

Gas connections

See **Gas connections Limas23 (model EL3020)** on page 58 and **Gas connections Limas23 (model EL3040)** on page 59.

Test gases – Limas23

Analyzer(s)	Test gas for the zero calibration	Test gas for the end-point calibration
Limas23 with calibration cells (automatic calibration)	N ₂ or air or UV sample component-free gas	Calibration cells or test gas for each sample component
Limas23 without calibration cells (automatic calibration)	N ₂ or air or UV sample component-free gas	Test gas for each sample component
Limas23 without calibration cells (manual calibration)	N ₂ or air or UV sample component-free gas	Test gas for each sample component
Limas23 + Magnos206 / Magnos28 or oxygen sensor with calibration cells (automatic calibration, i.e. Magnos206 / Magnos28 with single-point calibration)	N ₂ or oxygen and UV sample component-free gas	Either calibration cells and test gas for oxygen detector or test gas for each sample component or for each detector
Limas23 + Magnos206 / Magnos28 or oxygen sensor without calibration cells (automatic calibration)	N ₂ or oxygen and UV sample component-free gas	Test gas for each sample component or for each detector
Limas23 + Magnos206 / Magnos28 or oxygen sensor without calibration cells (manual calibration)	N ₂ or oxygen and UV sample component-free gas	Test gas for each sample component or for each detector

Dew point

The dew point of the test gases must be approximately equal to the dew point of the sample gas.

Note

The instructions for calibration must be observed, see Operating instruction.

... 3 Preparation for Installation

Magnos206

Sample gas

Sample gas inlet conditions

DANGER

Explosion hazard

Explosion hazard when measuring ignitable gas / air or gas / oxygen mixtures

- The gas analyzer may not be used for the measurement of ignitable gas / air or gas / oxygen mixtures

Magnos206 – sample gas input conditions

Temperature

- The sample gas dew point should be at least 5 °C below the temperature throughout the sample gas path. Otherwise a sample gas cooler or condensate trap is required.
- When there is a direct connection to the sample chamber, the maximum sample gas dew point is 55 °C.
- Water vapor content variations cause volume errors.

Designation of gas connections

The analyzer is operated under atmospheric pressure; the sample gas outlet is open to atmosphere.

Internal pressure drop: < 5 hPa at standard flow rate of 60 l/h.

Permissible absolute pressure range: 800 to 1250 hPa.

Operation under lower absolute pressure (e.g. at altitudes above 2000 m) on request.

Operation under higher pressure: A pressure sensor is required to compensate for pressure influences.

Absolute pressure ≤ 1250 hPa: An optional internal pressure sensor can be connected to the sample gas path.

Absolute pressure ≥ 1250 hPa: An external pressure sensor must be connected to the sample gas path. The pressure compensation must be calculated externally.

The analyzer module is function-tested for 5000 hPa internal pressure without damage.

Flow rate 30 to 90 l/h

Abrupt changes in the sample gas flow rate should be avoided when using highly suppressed measurement ranges.

Corrosive gases

If the sample gas contains Cl₂, HCl, HF or other corrosive components, the analyzer may only be used if the sample gas composition has been taken into account by the manufacturer for the configuration of the analyzer.

Flammable gases

The analyzer is suited for measuring flammable gases in a non-explosive environment.

Observe the special conditions when measuring flammable gases, see **Special conditions for the model EL3020 gas analyzer for the measurement of flammable gases** on page 14.

Pressure sensor

The pressure sensor is optionally installed in the gas analyzer, see **Pressure sensor** on page 33.

The pressure sensor is connected to a connection socket via an FPM tube.

For measurements in suppressed measurement ranges, the sensor and sample gas outlet have to be connected to each other via a T-piece and with the use of short conductors. Make especially sure that the gas discharge line is as short as possible or has a sufficiently large inside diameter (min. 10 mm) in case of a larger length.

Gas connections

See **Gas connections Magnos206 (model EL3020)** on page 66 and **Gas connections Magnos206 (model EL3040)** on page 67.

Test gases – Magnos206

Analyzer	Test gas for zero point calibration and single-point calibration	Test gas for the end-point calibration
Magnos206	Oxygen-free process gas	Process gas with a known O ₂ concentration
Magnos206 suppressed measuring range	<ul style="list-style-type: none"> Zero point calibration: pure nitrogen or hydrogen-free operating gas Single-point calibration: 100 Vol.-% O₂ or test gas with O₂ concentration in the measuring range 	Test gas with O ₂ concentration near the end point of the measuring range
Magnos206 with single-point calibration	Test gas with O ₂ concentration in an existing measuring range or ambient air.	—
Magnos206 with substitute gas calibration	Oxygen-free process gas or substitute gas (O ₂ in N ₂)	Substitute gas, for example dried air

Dew point

The dew point of the test gases must be approximately equal to the dew point of the sample gas.

Note

The instructions for calibration must be observed, see Operating instruction.

... 3 Preparation for Installation

Magnos28

Sample gas

Sample gas inlet conditions

DANGER

Explosion hazard

Explosion hazard when measuring ignitable gas / air or gas / oxygen mixtures

- The gas analyzer may not be used for the measurement of ignitable gas / air or gas / oxygen mixtures

Magnos28 – sample gas input conditions

Temperature

- The sample gas dew point should be at least 5 °C below the temperature throughout the sample gas path. Otherwise a sample gas cooler or condensate trap is required.
- When there is a direct connection to the sample chamber, the maximum sample gas dew point is 55 °C.
- Water vapor content variations cause volume errors.

Designation of gas connections

The analyzer is operated under atmospheric pressure; the sample gas outlet is open to atmosphere.

Internal pressure drop: < 5 hPa at standard flow rate of 60 l/h.

Permissible absolute pressure range: 800 to 1600 hPa.

Operation under lower absolute pressure (e.g. at altitudes above 2000 m) on request.

Operation under higher pressure: A pressure sensor is required to compensate for pressure influences.

Absolute pressure ≤ 1250 hPa: An optional internal pressure sensor can be connected to the sample gas path.

Absolute pressure ≥ 1250 hPa: An external pressure sensor must be connected to the sample gas path. The pressure compensation must be calculated externally.

The analyzer module is function-tested for 5000 hPa internal pressure without damage.

Flow rate 30 to 90 l/h

Abrupt changes in the sample gas flow rate should be avoided when using highly suppressed measurement ranges.

Corrosive gases

If the sample gas contains Cl₂, HCl, HF or other corrosive components, the analyzer may only be used if the sample gas composition has been taken into account by the manufacturer for the configuration of the analyzer. If the sample gas contains NH₃, FFKM75 gaskets must be used; in this case, the integral gas feed cannot be connected to the analyzer. The pressure sensor must not be connected to the sample gas path.

Flammable gases

The analyzer is suited for measuring flammable gases in a non-explosive environment.

Observe the special conditions when measuring flammable gases, see **Special conditions for the measurement of combustion gases** on page 38.

Pressure sensor

The pressure sensor is optionally installed in the gas analyzer, see **Pressure sensor** on page 33.

The pressure sensor is connected to a connection socket via an FPM tube.

For measurements in suppressed measurement ranges, the sensor and sample gas outlet have to be connected to each other via a T-piece and with the use of short conductors. Make especially sure that the gas discharge line is as short as possible or has a sufficiently large inside diameter (min. 10 mm) in case of a larger length.

Gas connections

See **Gas connections Magnos28 (model EL3020)** on page 68 and **Gas connections Magnos28 (model EL3040)** on page 72.

Test gases – Magnos28

Analyzer	Test gas for zero point calibration and single-point calibration	Test gas for the end-point calibration
Magnos28	Oxygen-free process gas	Process gas with a known O ₂ concentration
Magnos28 with a suppressed measuring range	<ul style="list-style-type: none"> Zero point calibration: pure nitrogen or hydrogen-free operating gas Single-point calibration: 100 Vol.-% O₂ or test gas with O₂ concentration in the measuring range 	Test gas with O ₂ concentration near the end point of the measuring range, or pure oxygen
Magnos28 with single-point calibration	Test gas with O ₂ concentration in an existing measuring range or ambient air.	—
Magnos28 with substitute gas calibration	Oxygen-free process gas or substitute gas (O ₂ in N ₂)	Substitute gas, for example dried air
Magnos28 + Caldos27 (manual calibration)	In addition to the above mentioned test gases for Magnos28, additional test gases are needed for the calibration of Caldos27. The requirements are shown in the table in section Test gases – Caldos27 on page 29.	
Magnos28 + Caldos27 (automatic calibration)	See the table in section Test gases – Caldos27 on page 29 for instructions on test gases and possible limitations in automatic calibration.	

Dew point

The dew point of the test gases must be approximately equal to the dew point of the sample gas.

Note

The instructions for calibration must be observed, see Operating instruction.

... 3 Preparation for Installation

Magnos27

Sample gas

Sample gas inlet conditions

DANGER

Explosion hazard

Explosion hazard when measuring flammable gases and ignitable gas / air or gas / oxygen mixtures

- The gas analyzer must not be used for measurement of flammable gases and ignitable gas / air or gas / oxygen mixtures.

Magnos27 – sample gas input conditions

Temperature

- The sample gas dew point should be at least 5 °C below the temperature throughout the sample gas path. Otherwise a sample gas cooler or condensate trap is required.
- When there is a direct connection to the sample chamber, the maximum sample gas dew point is 55 °C.
- Water vapor content variations cause volume errors.

Designation of gas connections

The analyzer is operated under atmospheric pressure; the sample gas outlet is open to atmosphere.

Internal pressure drop: < 5 hPa at standard flow rate of 60 l/h.

Permissible absolute pressure range: 800 to 1250 hPa.

Operation under lower absolute pressure (e.g. at altitudes above 2000 m) on request.

Gauge pressure in the measuring chamber: max. 500 hPa.

Flow rate 20 to 90 l/h

Pressure sensor

The pressure sensor is optionally installed in the gas analyzer (see **Pressure sensor** on page 33).

The pressure sensor is connected to a connection socket via an FPM tube.

Gas connections

See **Magnos27: Gas Connections** on page 73 and **Gas connections Magnos27 with Uras26 (model EL3020)** on page 74.

Tests gases – Magnos27

Analyzer	Test gas for the zero calibration	Test gas for the end-point calibration
Magnos27	Oxygen-free process gas	Process gas with a known O ₂ concentration
Magnos27 with substitute gas	Oxygen-free process gas or substitute gas (O ₂ in N ₂)	Substitute gas, for example dried air

Dew point

The dew point of the test gases must be approximately equal to the dew point of the sample gas.

Note

The instructions for calibration must be observed, see Operating instruction.

ZO23

Sample gas

Sample gas inlet conditions

DANGER

Explosion hazard

Explosion hazard when measuring ignitable gas / air or gas / oxygen mixtures

- The gas analyzer may not be used for the measurement of ignitable gas / air or gas / oxygen mixtures

ZO23 – sample gas input conditions

Temperature	5 to 50 °C
Inlet pressure	$p_e \leq 70$ hPa
Flow rate	4 to 20 l/h

- The sample gas flow rate must be kept constant within the specified range at ± 0.2 l/h.
- The sample gas must be taken unpressurized from a bypass. If the sample gas flow is too low, contamination effects from the gas lines (leaks, permeability, de-sorption) will lead to inaccuracies in the measurement result.

If the sample gas flow is too high, asymmetrical cooling of the sensor may cause measurement errors. This can also cause quicker aging or damage to the measuring cell.

Note

The temperature, pressure and flow of the sample gas must be kept constant, to such an extent that the influence of variations on the measuring accuracy is acceptable, refer to **Specification** on page 120.

Corrosive gases

The presence of corrosive gases and catalyst poisons, such as halogens, gases containing sulfur and heavy-metal dust, leads to quicker aging and / or the destruction of the ZrO_2 cell.

Flammable gases

The analyzer module is suitable for measuring flammable gases in a non-explosive environment. The concentration of flammable gases in the sample gas must not exceed 100 ppm.

Associated gas effect

Inert gases (Ar, N_2) have no effect. Flammable gases (CO, H_2 , CH_4) in stoichiometric concentrations to the oxygen content: conversion $O_2 < 20$ % of the stoichiometric conversion. If higher concentrations of flammable gases are present, higher O_2 conversions must be expected.

Requirements for the sample gas outlet

The outlet pressure must be the same as the atmospheric pressure.

Test gases

Reference point (electric zero point)

Clean ambient air;

its oxygen concentration is obtained from the dry air value and the factor for consideration of the water vapor content.

Example:

Water vapor content at 25 °C and 50 % relative humidity =

1.56 Vol.-% $H_2O \Leftrightarrow$ Factor 0.98

Oxygen concentration =

$20.93 \text{ vol. } \% O_2 \times 0.98 = 20.6 \text{ Vol.-% } O_2$

End position

Test gas with oxygen concentration in the smallest measurement range (for example, 2 ppm O_2 in N_2).

Note

The pressure conditions at the reference point and the end point must be identical.

The instructions for checking the reference point and the end point (see Operating instruction) must be observed.

Purge gas

If housing purging is selected (for IP65 design only), the purging may only be carried out using air (not with nitrogen), since the ambient air is used as a reference gas.

Gas connections

See sections **Gas connections ZO23 (model EL3020)** on page 75 and **Gas connections ZO23 (model EL3040)** on page 76.

... 3 Preparation for Installation

... Z023

Installation and sample handling

NOTICE

Damage to the measuring cell

The ingress of liquids into the analyzer module can cause serious damage including destruction of the sample cell.

Note

The following information on installation and the sample handling must be considered for the measurement and the execution of controlled calibrations (manual, automatic and externally controlled calibration).

Manually operated cocks and valves must be replaced by controlled valves suitable for the oxygen trace measurement, as required.

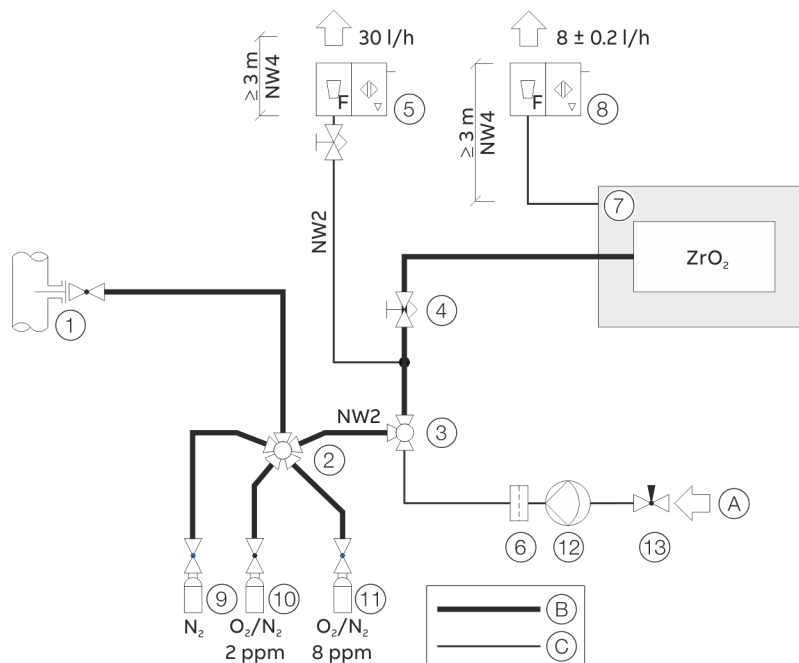

(A) Reference air

(B) Stainless steel pipe

(C) FPM hose

(1) Sampling point with primary shut-off valve

(2) Multi-way ball valve

(3) 3/2-way ball valve*

(4) Fine-control and shut-off valve

(5) Flowmeter with needle valve and fault-signalling contact

(6) Air filter*

(7) Gas analyzer

* Option

** A hard-mounted test gas cylinder is normally adequate.

The annual check of the reference point can also be carried out with a non-stationary air supply.

(8) Flowmeter without needle valve, with fault-signalling contact

(9) Purge gas cylinder N₂*

(10) Test gas cylinder with for example 2 ppm O₂ in N₂**

(11) Test gas cylinder with 8 ppm O₂ in N₂*

(12) Pump*

(13) Needle valve*

Figure 1: Sample handling example

Gas sampling

The nominal diameter of the line from the sampling point to the first switch-over valve should be 4 mm.

A bypass can be positioned upstream of the first switch-over valve, in order to obtain a faster analysis.

With a nominal diameter of 4 mm, the bypass should be longer than 3 m, in order to prevent back diffusion from the ambient air.

The sample gas pressure must be reduced at the sampling point. An evaporating pressure regulator must be provided for sampling from liquid gas lines.

Sample gas feed

The sample gas supply line must consist of stainless steel tubing, be as short as possible and have as few transitions as possible.

The diameter of tube from the beginning of the first switch-over valve should be 3 mm on the outside and 2 mm on the inside.

The sample gas connection on the gas analyzer is intended for a pipe with a 3 mm outside diameter.

The connectors should be made as Swagelok® fittings.

The ZO23 oxygen trace analyzer module may not be connected in series with other ZO23 analyzer modules or other gas analyzers.

Gas outlet line

The gas outlet line can be executed as a flexible tube.

With a nominal diameter of 4 mm, its length should be more than 3 m, in order to prevent back diffusion from the ambient air.

Bypass

The gas analyzer is connected to a gas flow in the bypass at a constant flow rate (approx. 30 l/h).

The needle valve is installed upstream of the branch to the gas analyzer and the bypass flowmeter downstream of the branch to the gas analyzer.

The gas analyzer draws gas flow 8 l/h. An excess of approx. 20 l/h remains. If several ZO23 analyzer modules are supplied with gas in parallel (redundant measurement), the flow must be set so large that the bypass has an excess of 20 l/h.

With a nominal diameter of 4 mm, the bypass from the outlet of the gas analyzer should be longer than 3 m, in order to prevent back diffusion from the ambient air.

On account of possible leaks, the flowmeters are always placed in the bypass feed path downstream of the branch to the gas analyzer, respectively, downstream of the gas analyzer; they may on no account be installed in the sample gas supply line upstream of the sample cell.

Waste gas

The sample gas and the bypass must be conducted into the atmosphere or into an unpressurized waste gas collecting system at an adequate distance from the gas analyzer.

Long line runs and pressure variations must be avoided.

For metrological and technical safety reasons, sample gas and bypass may not be discharged into the atmosphere in the vicinity of the gas analyzer, since the ambient air serves as reference air and also to exclude suffocation through a lack of oxygen.

It must be ensured that the waste gas only reaches respiratory air when adequately diluted.

... 3 Preparation for Installation

Caldos27

Sample gas

Sample gas inlet conditions

DANGER

Explosion hazard

Explosion hazard when measuring ignitable gas / air or gas / oxygen mixtures

- The gas analyzer may not be used for the measurement of ignitable gas / air or gas / oxygen mixtures

Pressure sensor

The pressure sensor is installed in the gas analyzer at the factory, see **Pressure sensor** on page 33.

The pressure sensor is connected to a connection socket via an FPM tube.

Gas connections

See sections **Gas connections Caldos27 (model EL3020)** on page 77 and **Gas connections Caldos27 (model EL3040)** on page 79.

Caldos27 – sample gas input conditions

Temperature

- The sample gas dew point should be at least 5 °C below the temperature throughout the sample gas path. Otherwise a sample gas cooler or condensate trap is required.
- Water vapor content variations cause volume errors.

Designation of gas connections

The analyzer is operated under atmospheric pressure; the sample gas outlet is open to atmosphere.

Internal pressure drop:	< 5 hPa at standard flow rate of 60 l/h.
-------------------------	--

Permissible absolute pressure range:	800 to 1250 hPa.
--------------------------------------	------------------

Operation under lower absolute pressure (e.g. at altitudes above 2000 m) on request.
--

Gauge pressure in the measuring chamber:	max. 100 hPa.
--	---------------

Flow rate	Typically 10 to 90 l/h, minimum 1 l/h
-----------	--

Corrosive gases

If the sample gas contains Cl₂, HCl, HF, SO₂, NH₃, H₂S or other corrosive components, the analyzer may only be used if the sample gas composition has been taken into account by the manufacturer for the configuration of the analyzer.

Flammable gases

The analyzer is suited for measuring flammable gases in a non-explosive environment.

Observe the special conditions when measuring flammable gases, see **Special conditions for the measurement of combustion gases** on page 38.

Test gases – Caldos27

Analyzer	Test gas for zero point calibration and single-point calibration	Test gas for the end-point calibration
Caldos27	Sample component-free test gas or process gas	Test gas or process gas with a known sample component concentration
Caldos27 with a suppressed measuring range	Test gas with a sample component concentration near the starting point of the measuring range	Test gas with a sample component concentration near the end point of the measuring range
Caldos27 with single-point calibration	Test gas with a known and constant rTC value (standard gas; possibly also dried room air)	—
Caldos27 + Magnos28 (manual calibration)	In addition to the above mentioned test gases for Caldos27, additional test gases are needed to calibrate Magnos28. The requirements are provided in the table in Test gases – Magnos28 on page 23.	
Caldos27 + Magnos28 (automatic calibration)	Same as manual calibration, with the following limitation: Zero point and single point calibrations are performed for all sample components simultaneously, since for this purpose, only one common digital output can be used for valve control (unlike with end point calibration) for this purpose (Calibration in the operating instruction). This results in limitations with regard to the possible test gases, which in particular depend on the configuration of the <ul style="list-style-type: none"> • Measurement components • Measuring ranges • Gas paths (series or isolated) Depending on these conditions, certain automatic calibration methods cannot be performed in a practical sense.	As in the case with manual calibration, a separate end point gas valve must be available for each sample component without a single point calibration, which is controlled via a correspondingly configured digital output (Calibration in the operating instruction).

Dew point

The dew point of the test gases must be approximately equal to the dew point of the sample gas.

Note

The instructions for calibration must be observed, see Operating instruction.

... 3 Preparation for Installation

Fidas24

Sample gas

Sample components

Hydrocarbons. The concentration of the gas components in the sample gas path must not exceed the temperature-dependent LEL. The analyzer temperature is 180 °C.

Sample gas inlet conditions

Fidas24 – sample gas input conditions

Temperature	≤ Thermostat temperature (thermostat temperature for sample gas path, detector and air injector ≤ 200 °C, factory-set at 180 °C)
Inlet pressure	$p_{abs} = 800$ to 1100 hPa
Flow rate	approx. 80 to 100 l/h at atmospheric pressure (1000 hPa)
Humidity	≤ 40 % H ₂ O

Note

The temperature, pressure and flow of the sample gas must be kept constant, to such an extent that the influence of variations on the measuring accuracy is acceptable.

Refer to **Specification** on page 120.

Requirements for the sample gas outlet

The outlet pressure must be the same as the atmospheric pressure.

Flammable gases

The gas analyzer may be used for the measurement of flammable gases provided that the flammable portion does not up-scale 15 Vol.-% CH₄ or does not up-scale C1 equivalents.

Further properties of the sample gas

The sample gas must not be explosive at any time.

The analyzer module must not be used for the measurement of gases containing organometallic compounds, e.g. lead-containing fuel additives or silicone oils.

Operational gases

Instrument air

Parameter	Value/Description
Quality	According to ISO 8573-1 Class 2 Particle size: max. 1 µm, Particle density: max. 1 mg/m ³ , Oil content: max. 0.1 mg/m ³ , Dew point: At least 10 °C below the lowest expected ambient temperature
Inlet pressure p_e	4000 hPa, ±500 hPa
Flow rate	Typically approx. 1800 l/h (1200 l/h for the air jet injector and approx. 600 l/h for the housing purge), max. approx. 2200 l/h (1500 l/h + 700 l/h)

Combustion air

Parameter	Value/Description
Quality	<ul style="list-style-type: none"> Synthetic air or catalytically purified air Organic hydrocarbon content: < 1 % of the measuring range
Inlet pressure p_e	1200 hPa, ±100 hPa
Flow rate	< 20 l/h

Combustion gas**⚠ DANGER****Explosion hazard**

Explosion hazard due to high combustion gas flow rate.

- The maximum combustion gas flow rate specified in the following table **Combustion gas parameter** on page 31 must not be up-scaled.
- For this purpose, the operator must install a suited flow restrictor and a shut-off valve in the combustion gas line.

NOTICE**Destruction of the detector**

Destruction of the detector due to overheating caused by incorrect combustion gas.

- For a design for H₂/He mix as a combustion gas, never use H₂ as a combustion gas!

Note

An H₂/He mixture may only be used if the gas analyzer has been ordered and delivered in the intended version.

Combustion gas parameter

Quality	Hydrogen (H ₂), Quality 5.0	H ₂ /He mix (40 %/60 %)
Inlet pressure p _e	1200 hPa, ±100 hPa	1200 hPa, ±100 hPa
Maximum combustion gas flow	approx. 3 l/h	approx. 10 l/h

Flow restrictor in the combustion gas supply line

The combustion gas flow rate must be limited to a maximum of 10 l/h H₂ or 25 l/h H₂/He mixture.

For this purpose, the operator has to provide suited measures outside the gas analyzer.

ABB recommends using a bulkhead fitting with an integrated flow restrictor to be installed in the combustion gas supply line.

This bulkhead fitting can be supplied by ABB.

- Combustion gas H₂: order number 8329303,
- Combustion gas H₂/He mix: order number 0769359.

Shut-off valve in the combustion gas supply line

A shut-off valve must be installed in the combustion gas supply line to increase safety in the following operating conditions:

- when shutting down the gas analyzer,
- in case of instrument air supply failure,
- in case of a leak in the combustion gas path, inside the gas analyzer.

This shut-off valve should be installed outside the analyzer house in the vicinity of the combustion gas supply (cylinder, line).

ABB recommends the use of a pneumatic shut-off valve that is actuated by the instrument air. This shut-off valve can be supplied by ABB.

Order number 0769440.

If such a pneumatic shut-off valve cannot be installed, precautions must be taken to monitor the overall status or the “failure” status of the gas analyzer, see **Failure of instrument air supply** on page 108.

... 3 Preparation for Installation

... Fidas24

Test gases

Test Gases for Zero Calibration	
Quality	Nitrogen, Quality 5.0, synthetic air or catalytically cleaned air with an organic C < 1 % MBU
Inlet pressure p_e	1000 hPa, ± 100 hPa
Flow rate	130 to 250 l/h

Test gases for endpoint calibration	
Quality	Sample component or substitute gas component in nitrogen or synthetic air with concentration adjusted to the measuring range
Inlet pressure p_e	1000 hPa, ± 100 hPa
Flow rate	130 to 250 l/h

Zero point offset

If the zero point gas is not completely free of hydrocarbons (even purified nitrogen contains fractions of hydrocarbons), negative measured values may be displayed in small measuring ranges.

In this case, the sample gas contains a lower proportion of hydrocarbons than the zero point gas.

Note

The calibration information under **Calibration** in the operating instruction must be taken into account.

Gas connections

See sections **Gas connections and electrical connections Fidas24 (model EL3020)** on page 80 and **Gas connections and electrical connections Fidas24 (model EL3040)** on page 81.

Sample gas input and output conditions

Analyzers

Analyzer	Additional Information
Uras26	See Uras26 on page 16
Limas23	See Limas23 on page 18
Magnos206	See Magnos206 on page 20
Magnos28	See Magnos28 on page 22
Magnos27	See Magnos27 on page 24
ZO23	See ZO23 on page 25
Caldos27	See Caldos27 on page 28
Fidas24	See Fidas24 on page 30

Oxygen sensor

Flammable gases

The oxygen sensor may not be used for the measurement of flammable gases.

Additional conditions

The H₂O dew point of the sample gas must be at least 2 °C.

The oxygen sensor may not be used if the sample gas contains the following components:

H₂S, compounds containing chlorine or fluorine, heavy metals, aerosols, mercaptans, alkaline components.

Integrated gas feed

Flammable gases

If the gas analyzer is equipped with the integrated gas feed, it must not be used for the measurement of flammable gases.

Note

Integrated gas feed can be used as an option in the EL3020 model. It cannot be used in the EL3040 model and not together with the Limas23, ZO23 and Fidas24 analyzers.

Special conditions for the model EL3040 gas analyzer in degree of protection II 3G

Flammable gases

The gas analyzer in explosion-proof design may be used for measurement of non-flammable gases and vapors.

Sample gas input pressure

Magnos28:

Maximum 1600 hPa absolute pressure

All other analyzer modules:

Maximum 1100 hPa absolute pressure or maximum 100 hPa gauge pressure

Pressure sensor

In which analyzer modules is a pressure sensor installed?

Gas analyzer	Pressure sensor
Uras26, Limas23, Caldos27	Factory-installed as standard
Magnos206, Magnos28, Magnos27	Factory-installed as an option
Fidas24, ZO23	Not required

Information for the safe and correct operation of the pressure sensor

NOTICE

Damage to the pressure sensor

Damage to the pressure sensor by corrosive gases.

- For the measurement of corrosive gases, the terminal of the pressure sensor must not be connected to the sample gas path.
- The pressure sensor must not be connected to the sample gas path if the sample gas contains flammable or ignitable components.
- Prior to the commissioning of the gas analyzer, the yellow plastic screw plug has to be screwed out of the connectors of the pressure sensor.
- For a precise pressure correction, the connection of the pressure sensor and sample gas outlet should be connected with each other via a T-piece and short lines. The lines must be as short as possible or – in the case of a greater length – have a sufficiently large inside diameter (min. 10 mm) so that the flow effect is minimized. If the pressure sensor is not connected to the sample gas output, the pressure sensor and sample gas output must be at the same level of pressure.
- Pressure sensor working range:
 $p_{abs} = 600$ to 1250 hPa.

Housing purge

Housing design

Housing purging is only possible with the wall-mounted housing (model EL3040). The purge gas connectors ($\frac{1}{8}$ NPT female thread) are factory-installed in accordance with the order.

Note

Housing purging in combination with Fidas24 is described separately, see **Housing purge with Fidas24** on page 34.

When is a housing purge necessary?

A housing purge is necessary when the sample gas contains flammable, corrosive or toxic components, see **Special conditions for the measurement of combustion gases** on page 38.

Purge gas

DANGER

Risk of suffocation

Risk of suffocation due to leaking purge gas. Purge gas can escape from the housing if there are any leak points.

- When using nitrogen as the purge gas, take all required precautions against suffocation.

NOTICE

Damage to the device

If the purge gas flow is not restricted until after the purge gas outlet, the full pressure of the purge gas will affect the housing seals which can destroy the operator panel keypad!

- The purge gas flow must always be restricted upstream of the purge gas inlet!

Suited purge gases

- Nitrogen for the measurement of flammable gases and
- Nitrogen or instrument air for the measurement of corrosive or toxic gases (Instrument air quality, based on ISO 8573-1 Class 3, i.e. particle size max. 40 μm , oil content max. 1 mg/m^3 , dew point max. +3° C).

Note

For Uras26, the purge gas must not contain any fractions of the sample components!

Any sample components in the purge gas can cause false readings.

... 3 Preparation for Installation

... Housing purge

Initial purging upon commissioning

Housing purge*

Purge gas	Nitrogen
Purge gas flow	Maximum 200 l/h
Purge time	Approx. 1 hour

* Not for Fidas24, see for a separate description at **Housing purge with Fidas24** on page 34.

If the purge gas flow is lower than specified, the duration of the purging must be extended accordingly.

Housing purge during operation

Purge gas flow	At the device input max. 20 l/h (constant)
Purge gas overpressure	$p_e = 2$ to 4 hPa

For a purge gas flow rate of 20 l/h at the device inlet, the purge gas flow rate at the device outlet is approx. 5 to 10 l/h.

Housing purge during operation when measuring flammable gases

The housing must be purged using nitrogen. Purge gas flow rate 1 to 20 l/h. The purge gas flow must be monitored at the purge gas output.

Housing purge with Fidas24

In the Fidas24 gas analyzer, the housing purge is provided in such a way that a part (approx. 600 to 700 l/h) of the instrument air is conducted continuously through the housing as purge air.

Thus it is guaranteed that no ignitable gas mixture can form within the housing in case of a leak in the combustion gas path. The housing purge is always active when pressurized air is on, that is also when the instrument air valve is closed.

Dimensions

19" housing (model EL3020)

Dimensions in mm (in)

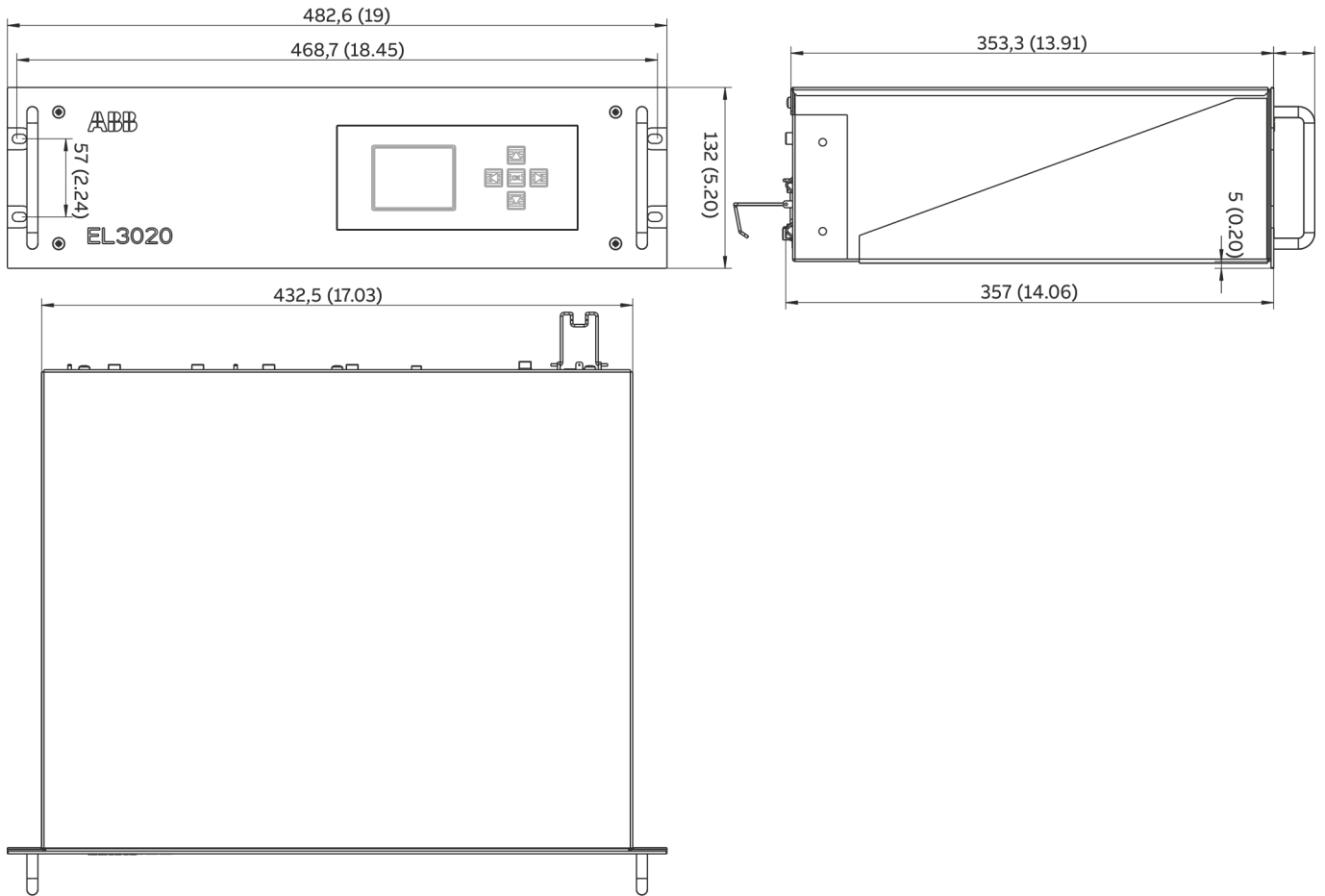

Figure 2: 19" housing (model EL3020)

... 3 Preparation for Installation

... Dimensions

19" housing (model EL3020 with Magnos27)

Dimensions in mm (in)

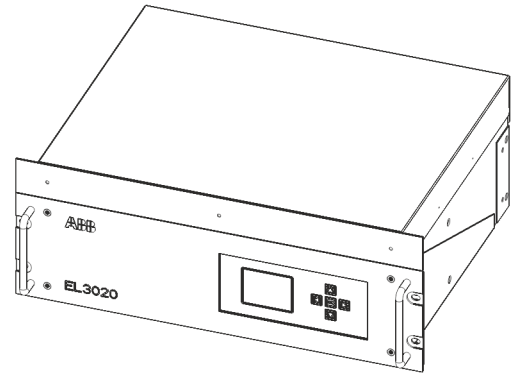
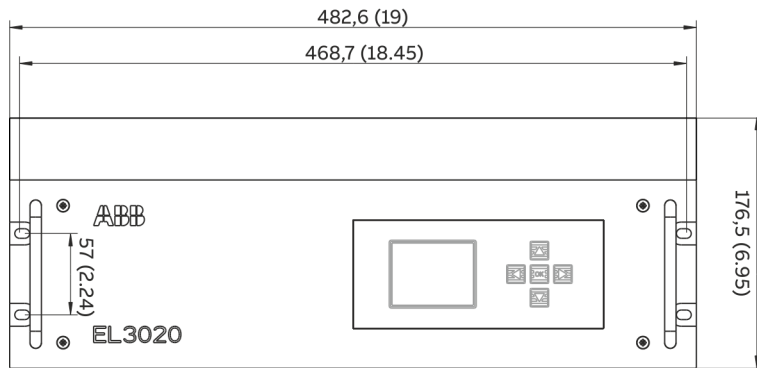

Figure 3: 19" housing (model EL3020 with Magnos27)

Note

Only the front view of the housing (with its height differing from the standard dimension) is depicted in this dimensional drawing. Additional views and dimensions of the 19" housing are shown in Figure 2.

Wall-mount housing (model EL3040)

Dimensions in mm (in)

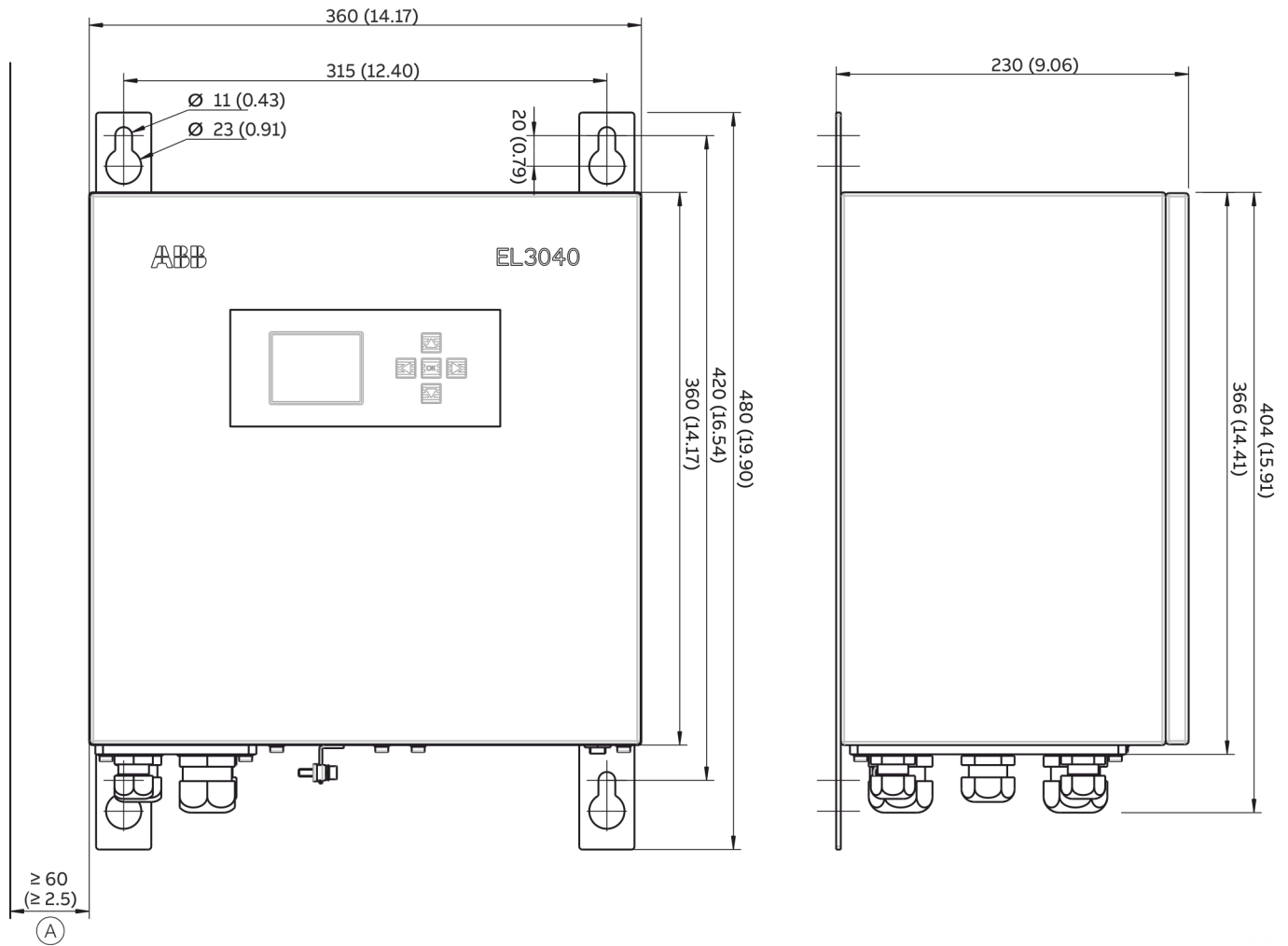

(A) Consider free space to swivel the door

Figure 4: Wall-mount housing (model EL3040)

... 3 Preparation for Installation

Special conditions for the measurement of combustion gases

DANGER

Explosion hazard

Explosion hazard due to the formation of explosive gas mixtures when measuring flammable gases and connecting oxygen-containing test gases (such as air).

- Before connecting an oxygen-containing test gas, the gas path must be rinsed with an inert gas, such as nitrogen.
- Observe the following **safety instructions regarding calibration**.

Safety instructions regarding calibration

When measuring flammable gases, observe the following instructions:

- When calibrating the analyzers, air must not directly be connected as a test gas after operation with flammable gases.
- Alternatively, where possible, use nitrogen as test gas for calibration instead of air (for example, for zero point calibration of Uras26 or single point calibration of Magnos206 and Magnos28).

This must be particularly considered for automatically controlled calibration processes, since no automatic purging with an inert gas is possible.

Note

The version for the measurement of flammable gases and the explosion-proof design in degree of protection II 3G (see **Use in potentially explosive atmospheres** on page 9) are designed for various variants of the gas analyzer and for different applications.

Installation of the gas analyzer

- The pressure sensor must not be connected to the sample gas path.
- The sample gas lines and connections must be made of stainless steel.
- Before using the gas analyzer, corrosion resistance against the specific sample gas must be checked.
- Only model EL3020:
 - Unrestricted exchange of air with the environment must be provided around the gas analyzer from the bottom (floor plate) and from the rear (gas connections).
 - The gas analyzer may not be placed directly on a table.
 - The housing openings may not be closed.
 - Spacing to adjacent built-in components to the sides must be at least 3 cm.
- Only model EL3020 when installed in a closed cabinet:
 - Sufficient ventilation of the cabinet must be provided (at least 1 × air change per hour).
 - The spacing to adjoining fittings from the bottom (floor plate) and from the back (gas connections) must be at least 3 cm.

Commissioning of the gas analyzer

- The sample gas path must be purged with inert gas before the gas analyzer is commissioned (see **Purge sample gas path and analyzer housing** on page 100).

Operation and Maintenance of the Gas Analyzer

- Only model EL3040:
 - The housing must be purged using nitrogen.
 - Purge gas flow rate 1 to 20 l/h.
 - The purge gas flow must be monitored at the purge gas output.
- The gauge pressure in the sample gas feed path may not upscale the maximum value of 100 hPa in standard operation and a maximum value of 500 hPa in the event of a fault. The gas analyzer with Magnos28 can be used up to an absolute pressure of 1200 hPa.
- The leak tightness of the sample gas path must be checked regularly (see **Checking gas path leak tightness** on page 105).
- After the sample gas path within the gas analyzer has been opened, the following measures (see **Measures to take after each opening of the gas paths within the gas analyzer** on page 107) must be taken:
 - The leak tightness of the sample gas path must be checked.
 - The sample gas path must be purged with inert gas before the power supply is switched on.

4 Installation

Unpacking the Gas Analyzer

CAUTION

Injury hazard due to heavy weight

Depending on the version, the gas analyzer weighs 7 to 15 kg (19" housing – model EL3020) or 13 to 21 kg (wall-mounted housing – model EL3040)!

- Two persons are required for unpacking and transportation!

Check the devices immediately after unpacking for possible damage that may have occurred from improper transport. Details of any damage that has occurred in transit must be recorded on the transport documents.

All claims for damages must be submitted to the shipper without delay and before installation.

1. Remove the accessories (refer to **Scope of delivery** on page 12) from the transport carton. Take care not to lose any of the accessories.
2. Remove the gas analyzer from the carton, together with the padding material.
3. Remove the padding material and place the gas analyzer in a clean area.
4. Clean the adhesive packaging residue from the gas analyzer.

Note

Keep the shipping carton and cushioning material for future transportation.

Name plate

Contents of the name plate

The name plate contains the following information:

- Production Number (P-No.),
- Order Number (O-No.),
- Power supply (voltage, frequency, max. power consumption),
- Installed analyzers with measurement components and measuring ranges.

Analyzer data sheet

Contents

The analyzer data sheet contains the following information:

- Order Number (O-No.),
- Job number (J-No.)
- Production Number (P-No.),
- Production Date,
- Power supply (voltage, frequency, max. power consumption),
- Measuring components and measuring ranges,
- Serial numbers of the installed modules.

Storage of the Analyzer Data Sheet

- on the left-hand side panel inside the 19"-housing (model EL3020) and
- on the door glued inside the wall-mount housing (model EL3040).

Note

- Keep the analyzer data sheet in the gas analyzer so that it is always at hand, especially in case of service/maintenance, refer to **Service address** on page 8.
- During commissioning, observe the information in the analyzer data sheet. The information given in the analyzer data sheet may differ from the general information in this regard Commissioning Instruction.

Mounting the fittings on the gas analyzer

General information

To connect the gas lines to the gas analyzer, screw-in sockets (fittings) are used in different designs.

Depending on the design, the fittings are included in the scope of delivery or must be provided during the assembly.

The different designs of gas connections are listed in Table Position and design of the gas connections.

Note

It is recommended that the fittings be installed on the analyzer module before the gas analyzer is mounted, as the connection ports are still easily accessible before the analyzer is mounted.

Fittings

- The fittings used must be clean and free of residue!
 - Impurities from the fittings can enter the analyzer and damage it. They could also falsify the measurement result.
- Observe the installation instructions provided by the manufacturers of the fittings!
- Hold back the screw connections when connecting the gas lines!

Gaskets

Do not use sealing compound to seal the fittings!
Some components of the sealing paste could falsify the measurement results.

Requisite Material

Screw-in spud with hose nozzles (supplied) or screw-in fittings with 1/8 NPT thread and PTFE sealing tape.

Installing the fittings

1. Screw out the yellow plastic screwing caps (5 mm hexagon socket) from the connection ports.
2. Wrap PTFE sealing tape tightly around the thread of the screw-in fitting twice, clockwise, and screw it into the connection socket.
After mounting, approx. 2 threads usually remain visible

Note

Screw the fittings in carefully, and not too tightly!

Checking gas path leak tightness

The leak tightness of the sample gas path is tested at the factory.

However, since it may be impaired when transporting the gas analyzer (for example, due to severe vibrations), we recommend that you check it prior to commissioning at the installation site (see **Checking gas path leak tightness** on page 105).

Note

We strongly recommend checking the tightness of the gas feed paths before the gas analyzer is assembled, since the housing must be opened in the event of a leak.

... 4 Installation

Position and design of the gas connections

The following pages list the location and execution of the gas connections of the individual analyzer modules and their combinations.

The table below is used as an aid in navigating the connection descriptions.

Position and design of the gas connections		
Analyzer module	Model EL3020	Model EL3040
Uras26	see page 43	see page 45
Uras26 with Magnos206	see page 46	see page 48
Uras26 with Magnos28	see page 50	see page 52
Uras26 with Caldos27	see page 54	see page 56
Limas23	see page 58	see page 59
Limas23 with Magnos206	see page 60	see page 61
Limas23 with Magnos28	see page 63	see page 64
Magnos206	see page 66	see page 67
Magnos28	see page 68	see page 72
Magnos28 with Magnos28	see page 69	—
Magnos28 with Caldos27	see page 70	—
Magnos27	see page 73	—
Magnos27 with Uras26	see page 74	—
ZO23	see page 75	see page 76
Caldos27	see page 77	see page 79
Caldos27 with Caldos27	see page 78	—
Fidas24	see page 80	see page 81

Gas connections Uras26 (model EL3020)

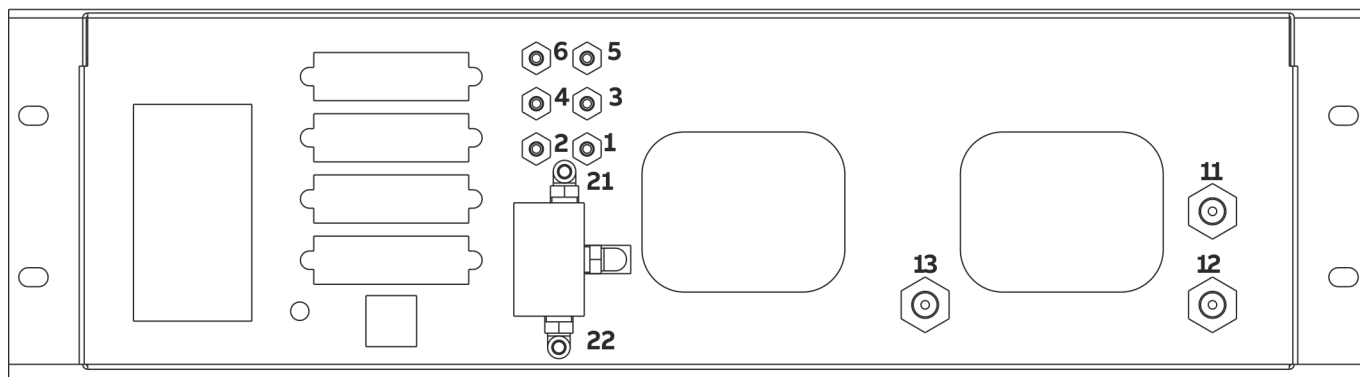

Figure 5: Gas connections Uras26 (EL3020)

Uras26: Gas connections for hose lines (internal gas lines made using hoses)

Pos.	Connection	Supplementary information	Version
1	Sample gas inlet (gas path 1)	Without 'integrated gas feed' option	Screwed connections with hose nozzles (stainless steel 1.4305) for hoses with 4 mm inside diameter (included in scope of supply)
2	Sample gas outlet (gas path 1)	—	
3	Sample gas outlet (gas path 1)	For 'Integrated gas feed' option, factory-connected to sample gas inlet Pos. 1 (gas path 1)	
4	Sample gas inlet (gas path 1)	For 'Integrated gas feed' option with flow sensor only (without solenoid valve)	Screwed fittings with hose nozzles (PVDF) for hoses with 4 mm inside diameter (included in scope of supply)
	Pressure sensor	For 'Pressure sensor connected to the outside by hose' option	
5	Sample gas inlet (gas path 2)	For second sample gas or flowing reference gas, sample cell	
6	Sample gas outlet (gas path 2)	1 (depending on the design of the analyzer)	
21	Sample gas inlet (gas path 1)	On solenoid valve with 'integral gas feed' option with	Screwed fittings with hose nozzles (PVDF) for hoses with 4 mm inside diameter (included in scope of supply)
22	Test gas inlet (gas path 1)	solenoid valve, pump, filter, capillary and flow sensor	

Note

The pressure sensor (standard, not for the 'pressure sensor connected to outside by hose' option), and the oxygen sensor (option) are internally connected as follows:

- In the output of the measuring cell 1, with a measuring cell and in the case of separate gas paths.
- In the output of measuring cells 2 for two measuring cells in series.
- The second O₂ sensor (option for version with separate gas paths) is connected downstream of the sample cell 2 outlet.

... 4 Installation

... Position and design of the gas connections

Uras26: Gas connections for pipelines

(internal gas lines made stainless steel pipes)

Pos.	Connection	Supplementary information	Version
6	Pressure sensor	—	Screwed connections with hose nozzles (stainless steel 1.4305) for hoses with 4 mm inside diameter (included in scope of supply)
11	Sample gas inlet	—	1/8 NPT female thread (stainless steel 1.4305) for threaded connections
12	Sample gas outlet	For a sample cell	
13	Sample gas outlet	For two sample cells in series	(not included in scope of supply)

Note

The oxygen sensor, the 'integrated gas feed' option and the version with separated gas paths are not possible.

Gas connections Uras26 (model EL3040)

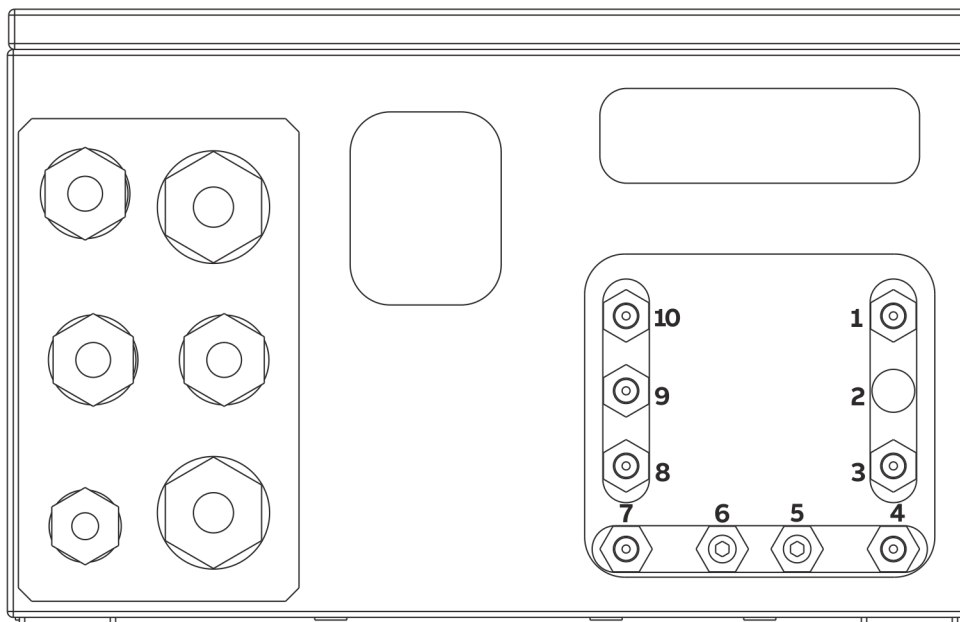

Figure 6: Gas connections Uras26 (model EL3040)

Uras26: Gas connections

Pos.	Connection	Supplementary information	Version
1	Pressure sensor	The pressure sensor is connected to the Pos. 1 terminal if the internal gas lines are designed as stainless steel pipes, or if the 'Pressure sensor connected outside by hose' option is ordered.	<ul style="list-style-type: none"> • 1/8 NPT female thread (stainless steel 1.4305) • Connection of hose lines: straight screw-in socket (PP) with hose nozzles for hoses with inside diameter 4 mm (included in scope of delivery)
2	Not assigned	—	
3	Sample gas inlet (gas path 1)	—	<ul style="list-style-type: none"> • Connection of piping: screw-in fittings (not included in scope of delivery)
4	Sample gas outlet (gas path 1)	For a measuring cell and for two measuring cells with separate gas paths	
5	Purge gas inlet (housing)	—	
6	Purge gas outlet (housing)	—	
7	Sample gas inlet (gas path 2)	—	
8	Sample gas outlet (gas path 2)	—	
	Sample gas outlet (gas path 1)	For two sample cells in series	
9	Reference gas inlet	Sample cell 1 flowing reference gas	
10	Reference gas outlet		

Note

- If the internal gas lines are designed as hoses, the pressure sensor (standard, not for the 'pressure sensor connected to outside by hose' option), and the oxygen sensor (option) are internally connected as follows:
 - In the output of measuring cell 1, for one measuring cell and for two measuring cells with separate gas paths.
 - In the output of measuring cell 2 for two measuring cells in a series.
 - The second oxygen sensor (option for version with separate gas paths) is connected in the outlet of sample cell 2.
- If the internal gas lines are designed as stainless steel pipes, the oxygen sensor and the version with separated gas paths are not possible.

... 4 Installation

... Position and design of the gas connections

Gas connections Uras26 with Magnos206 (model EL3020)

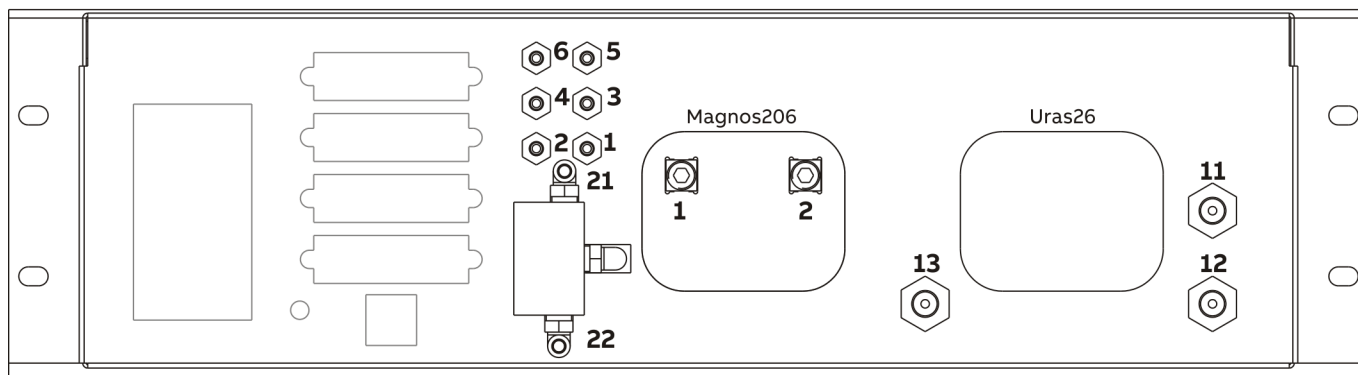

Figure 7: Gas connections Uras26 with Magnos206 (model EL3020)

Uras26: Gas connections for hose lines (internal gas lines made using hoses)

Pos.	Connection	Supplementary information	Version
1	Sample gas inlet (gas path 1)	Without 'integrated gas feed' option	Screwed connections with hose nozzles (stainless steel 1.4305) for hoses with 4 mm inside diameter (included in scope of supply)
2	Sample gas outlet (gas path 1)	—	
3	Sample gas outlet (gas path 1)	For 'Integrated gas feed' option, factory-connected to sample gas inlet Pos. 1 (gas path 1)	
4	Sample gas inlet (gas path 1)	For 'Integrated gas feed' option with flow sensor only (without solenoid valve)	Screwed fittings with hose nozzles (PVDF) for hoses with 4 mm inside diameter (included in scope of supply)
	Pressure sensor	For 'Pressure sensor connected to the outside by hose' option	
5	Sample gas inlet (gas path 2)	For second sample gas or flowing reference gas, sample	Screwed connections with hose nozzles (stainless steel 1.4305) for hoses with 4 mm inside diameter (included in scope of supply)
6	Sample gas outlet (gas path 2)	cell 1 (depending on the design of the analyzer)	
21	Sample gas inlet (gas path 1)	On solenoid valve with 'integral gas feed' option with	Screwed fittings with hose nozzles (PVDF) for hoses with 4 mm inside diameter (included in scope of supply)
22	Test gas inlet (gas path 1)	solenoid valve, pump, filter, capillary and flow sensor	

Note

- The oxygen sensor is not possible in combination with Magnos206
- The pressure sensor (standard, not for the 'pressure sensor connected to outside by hose' option) are internally connected as follows:
 - In the output of the measuring cell 1, with a measuring cell and in the case of separate gas paths.
 - In the output of measuring cell 2 for two measuring cells in a series.

Uras26: Gas connections for pipelines

(internal gas lines made stainless steel pipes)

Pos.	Connection	Supplementary information	Version
6	Pressure sensor	—	Screwed connections with hose nozzles (stainless steel 1.4305) for hoses with 4 mm inside diameter (included in scope of supply)
11	Sample gas inlet	—	1/8 NPT female thread (stainless steel 1.4305) for threaded connections
12	Sample gas outlet	For a sample cell	
13	Sample gas outlet	For two sample cells in series	(not included in scope of supply)

Note

The oxygen sensor, the 'integrated gas feed' option and the version with separated gas paths are not possible.

Magnos206: Gas Connections

Pos.	Connection	Supplementary information	Version
1	Sample gas inlet	—	1/8 NPT female thread (stainless steel 1.4305)
2	Sample gas outlet	—	<ul style="list-style-type: none"> • Connection of hose lines: straight screw-in socket (PP) with hose nozzles for hoses with inside diameter 4 mm (included in scope of delivery) • Connection of piping: screw-in fittings (not included in scope of delivery)

Note

The sample gas inlet of Magnos206 can be connected to the sample gas output (gas path 1) of Uras26 at the factory or have a separate sample gas path without connection to Uras26.

... 4 Installation

... Position and design of the gas connections

Gas connections Uras26 with Magnos206 (model EL3040)

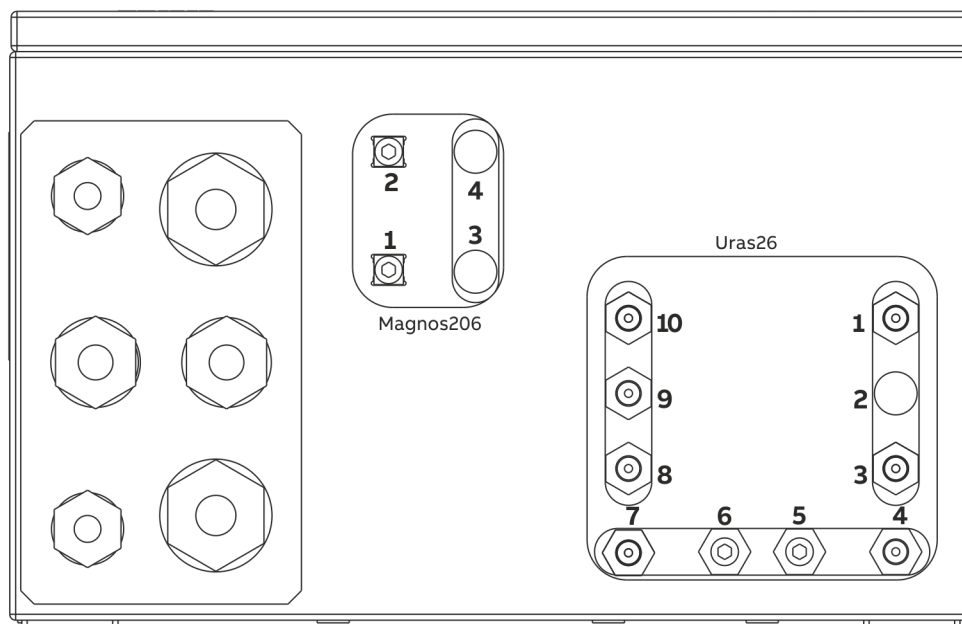

Figure 8: Gas connections Uras26 with Magnos206 (model EL3040)

Uras26: Gas connections

Pos.	Connection	Supplementary information	Version
1	Pressure sensor	The pressure sensor is connected to the Pos. 1 terminal if the internal gas lines are designed as stainless steel pipes, or if the 'Pressure sensor connected outside by hose' option is ordered.	<ul style="list-style-type: none"> • 1/8 NPT female thread (stainless steel 1.4305) • Connection of hose lines: straight screw-in socket (PP) with hose nozzles for hoses with inside diameter 4 mm (included in scope of delivery) • Connection of piping: screw-in fittings (not included in scope of delivery)
2	Not assigned	—	
3	Sample gas inlet (gas path 1)	—	
4	Sample gas outlet (gas path 1)	For a measuring cell and for two measuring cells with separate gas paths	
5	Purge gas inlet (housing)	—	
6	Purge gas outlet (housing)	—	
7	Sample gas inlet (gas path 2)	—	
8	Sample gas outlet (gas path 2)	—	
	Sample gas outlet (gas path 1)	For two sample cells in series	
9	Reference gas inlet	Sample cell 1 flowing reference gas	
10	Reference gas inlet		

Note

- The oxygen sensor is not possible in combination with Magnos206
- If the internal gas lines are designed as hoses, the pressure sensor (standard, not for the 'pressure sensor connected to outside by hose' option), and the oxygen sensor (option) are internally connected as follows:
 - In the output of measuring cell 1, for one measuring cell and for two measuring cells with separate gas paths.
 - In the output of measuring cells 2 for two measuring cells in series.
- If the internal gas lines are designed as stainless steel pipes, the version with separate gas paths is not possible.

Magnos206: Gas Connections

Pos.	Connection	Supplementary information	Version
1	Sample gas inlet	—	1/8 NPT female thread (stainless steel 1.4305)
2	Sample gas outlet	—	<ul style="list-style-type: none"> • Connection of hose lines: straight screw-in socket (PP) with hose nozzles for hoses with inside diameter 4 mm (included in scope of delivery) • Connection of piping: screw-in fittings (not included in scope of delivery)
3	Not assigned	—	
4	Not assigned	—	

Note

The sample gas inlet of Magnos206 can be connected to the sample gas output (gas path 1) of Uras26 at the factory or have a separate sample gas path without connection to Uras26.

... 4 Installation

... Position and design of the gas connections

Gas connections Uras26 with Magnus28 (model EL3020)

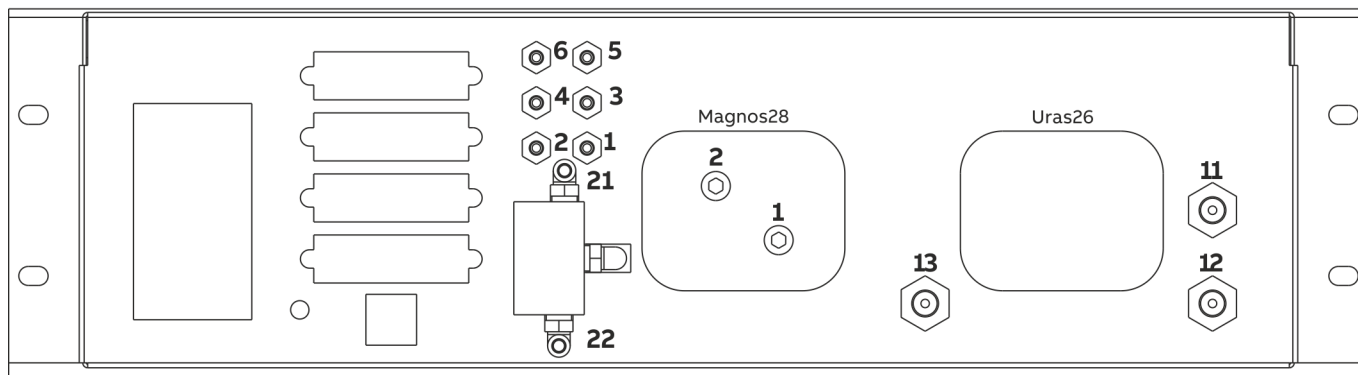

Figure 9: Gas connections Uras26 with Magnus28 (EL3020)

Uras26: Gas connections for hose lines (internal gas lines made using hoses)

Pos.	Connection	Supplementary information	Version
1	Sample gas inlet (gas path 1)	Without 'integrated gas feed' option	Screwed connections with hose nozzles (stainless steel 1.4305) for hoses with 4 mm inside diameter (included in scope of supply)
2	Sample gas outlet (gas path 1)	—	
3	Sample gas outlet (gas path 1)	For 'Integrated gas feed' option, factory-connected to sample gas inlet Pos.1 (gas path 1)	
4	Sample gas inlet (gas path 1)	For 'Integrated gas feed' option with flow sensor only (without solenoid valve)	Screwed fittings with hose nozzles (PVDF) for hoses with 4 mm inside diameter (included in scope of supply)
	Pressure sensor	For 'Pressure sensor connected to the outside by hose' option	
5	Sample gas inlet (gas path 2)	For second sample gas or flowing reference gas, sample cell 1 (depending on the design of the analyzer)	
6	Sample gas outlet (gas path 2)		
21	Sample gas inlet (gas path 1)	On solenoid valve with 'integral gas feed' option with	Screwed fittings with hose nozzles (PVDF) for hoses with 4 mm inside diameter (included in scope of supply)
22	Test gas inlet (gas path 1)	solenoid valve, pump, filter, capillary and flow sensor	

Note

- The oxygen sensor is not possible in combination with Magnus28
- The pressure sensor (standard, not for the 'pressure sensor connected to outside by hose' option) are internally connected as follows:
 - In the output of the measuring cell 1, with a measuring cell and in the case of separate gas paths.
 - In the output of measuring cell 2 for two measuring cells in a series.

Uras26: Gas connections for pipelines

(internal gas lines made stainless steel pipes)

Pos.	Connection	Supplementary information	Version
6	Pressure sensor	—	Screwed connections with hose nozzles (stainless steel 1.4305) for hoses with 4 mm inside diameter (included in scope of supply)
11	Sample gas inlet	—	1/8 NPT female thread (stainless steel 1.4305) for threaded connections
12	Sample gas outlet	For a sample cell	
13	Sample gas outlet	For two sample cells in series	(not included in scope of supply)

Note

The oxygen sensor, the 'integrated gas feed' option and the version with separated gas paths are not possible.

Magnos28: Gas Connections

Pos.	Connection	Supplementary information	Version
1	Sample gas inlet	—	1/8 NPT female thread (stainless steel 1.4305)
2	Sample gas outlet	—	<ul style="list-style-type: none"> • Connection of hose lines: straight screw-in socket (PP) with hose nozzles for hoses with inside diameter 4 mm (included in scope of delivery) • Connection of piping: screw-in fittings (not included in scope of delivery)

Note

The sample gas inlet of Magnos28 can be optionally connected at the factory to the sample gas output (gas path 1) of Uras26 or have a separate sample gas path without connection to Uras26.

... 4 Installation

... Position and design of the gas connections

Gas connections Uras26 with Magnos28 (model EL3040)

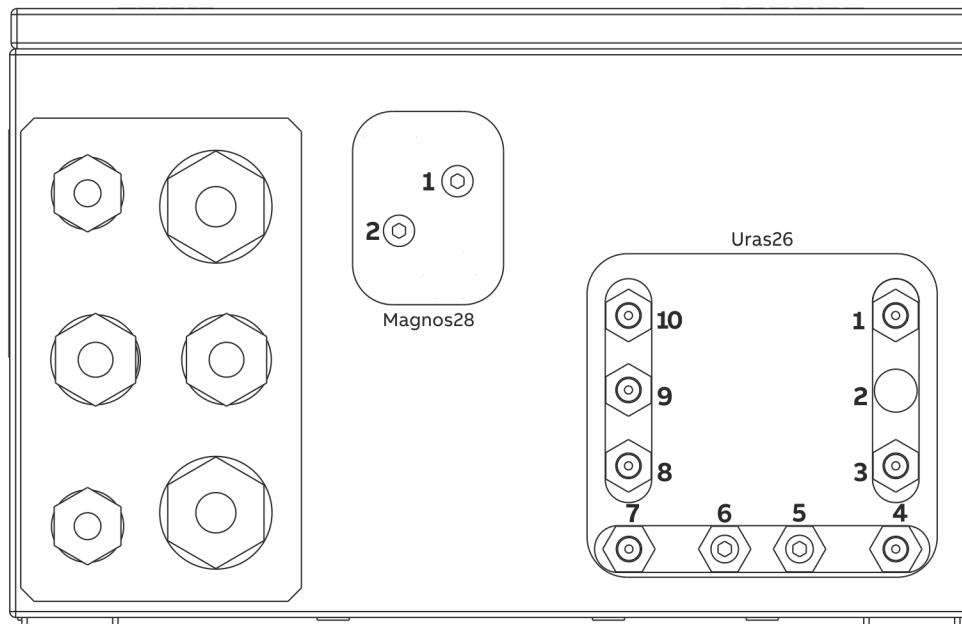

Figure 10: Gas connections Uras26 with Magnos28 (model EL3040)

Uras26: Gas connections

(internal gas lines made using hoses or stainless steel pipes)

Pos.	Connection	Supplementary information	Version
1	Pressure sensor	The pressure sensor is connected to the Pos. 1 terminal if the internal gas lines are designed as stainless steel pipes, or if the 'Pressure sensor connected outside by hose' option is ordered.	<ul style="list-style-type: none"> • ½ NPT female thread (stainless steel 1.4305) • Connection of hose lines: straight screw-in socket (PP) with hose nozzles for hoses with inside diameter 4 mm (included in scope of delivery) • Connection of piping: screw-in fittings (not included in scope of delivery)
2	Not assigned	—	
3	Sample gas inlet (gas path 1)	—	
4	Sample gas outlet (gas path 1)	For a measuring cell and for two measuring cells with separate gas paths	
5	Purge gas inlet (housing)	—	
6	Purge gas outlet (housing)	—	
7	Sample gas inlet (gas path 2)	—	
8	Sample gas outlet (gas path 2)	—	
	Sample gas outlet (gas path 1)	For two sample cells in series	
9	Reference gas inlet	Sample cell 1 flowing reference gas	
10	Reference gas inlet		

Note

- The oxygen sensor is not possible in combination with Magnos28
- If the internal gas lines are designed as hoses, the pressure sensor (standard, not for the 'pressure sensor connected to outside by hose' option), and the oxygen sensor (option) are internally connected as follows:
 - In the output of measuring cell 1, for one measuring cell and for two measuring cells with separate gas paths.
 - In the output of measuring cells 2 for two measuring cells in series.
- If the internal gas lines are designed as stainless steel pipes, the version with separate gas paths is not possible.

Magnos28: Gas Connections

Pos.	Connection	Supplementary information	Version
1	Sample gas inlet	—	½ NPT female thread (stainless steel 1.4305)
2	Sample gas outlet	—	<ul style="list-style-type: none"> • Connection of hose lines: straight screw-in socket (PP) with hose nozzles for hoses with inside diameter 4 mm (included in scope of delivery) • Connection of piping: screw-in fittings (not included in scope of delivery)

Note

The sample gas inlet of Magnos28 can be optionally connected at the factory to the sample gas output (gas path 1) of Uras26 or have a separate sample gas path without connection to Uras26.

... 4 Installation

... Position and design of the gas connections

Gas connections Uras26 with Caldos27 (model EL3020)

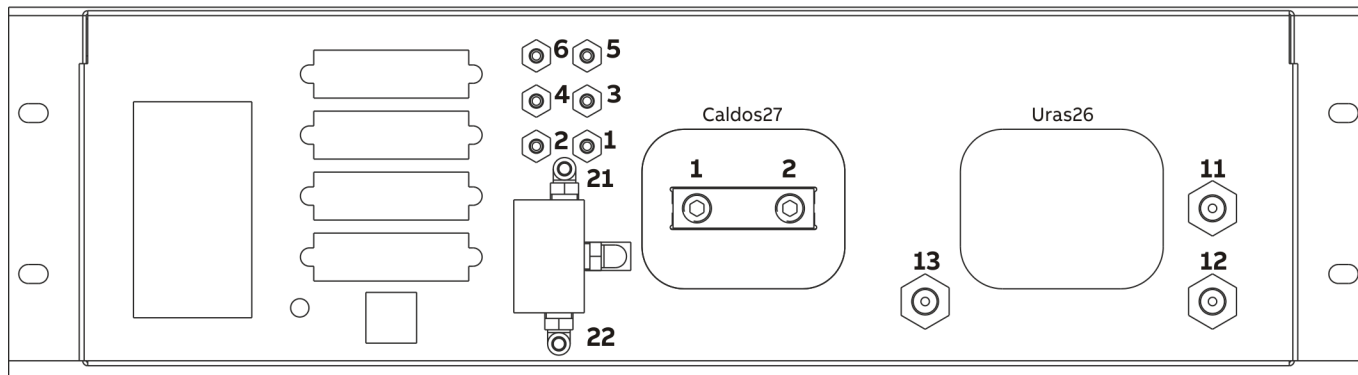

Figure 11: Gas connections Uras26 with Caldos27 (model EL3020)

Uras26: Gas connections for hose lines (internal gas lines made using hoses)

Pos.	Connection	Supplementary information	Version
1	Sample gas inlet (gas path 1)	Without 'integrated gas feed' option	Screwed connections with hose nozzles (stainless steel 1.4305) for hoses with 4 mm inside diameter (included in scope of supply)
2	Sample gas outlet (gas path 1)	—	
3	Sample gas outlet (gas path 1)	For 'Integrated gas feed' option, factory-connected to sample gas inlet Pos. 1 (gas path 1)	
4	Sample gas inlet (gas path 1)	For 'Integrated gas feed' option with flow sensor only (without solenoid valve)	Screwed fittings with hose nozzles (PVDF) for hoses with 4 mm inside diameter (included in scope of supply)
	Pressure sensor	For 'Pressure sensor connected to the outside by hose' option	
5	Sample gas inlet (gas path 2)	For second sample gas or flowing reference gas, sample	Screwed fittings with hose nozzles (PVDF) for hoses with 4 mm inside diameter (included in scope of supply)
6	Sample gas outlet (gas path 2)	cell 1 (depending on the design of the analyzer)	
21	Sample gas inlet (gas path 1)	On solenoid valve with 'integral gas feed' option with	Screwed fittings with hose nozzles (PVDF) for hoses with 4 mm inside diameter (included in scope of supply)
22	Test gas inlet (gas path 1)	solenoid valve, pump, filter, capillary and flow sensor	

Note

- The oxygen sensor is not possible in combination with Caldos27
- The pressure sensor (standard, not for the 'pressure sensor connected to outside by hose' option) are internally connected as follows:
 - In the output of the measuring cell 1, with a measuring cell and in the case of separate gas paths.
 - In the output of measuring cell 2 for two measuring cells in a series.

Uras26: Gas connections for pipelines

(internal gas lines made stainless steel pipes)

Pos.	Connection	Supplementary information	Version
6	Pressure sensor	—	Screwed connections with hose nozzles (stainless steel 1.4305) for hoses with 4 mm inside diameter (included in scope of supply)
11	Sample gas inlet	—	1/8 NPT female thread (stainless steel 1.4305) for threaded connections
12	Sample gas outlet	For a sample cell	
13	Sample gas outlet	For two sample cells in series	(not included in scope of supply)

Note

The oxygen sensor, the 'integrated gas feed' option and the version with separated gas paths are not possible.

Caldos27: gas connections

Pos.	Connection	Supplementary information	Version
1	Sample gas inlet	—	1/8 NPT female thread (stainless steel 1.4305)
2	Sample gas outlet	—	<ul style="list-style-type: none"> • Connection of hose lines: straight screw-in socket (PP) with hose nozzles for hoses with inside diameter 4 mm (included in scope of delivery) • Connection of piping: screw-in fittings (not included in scope of delivery)

Note

The sample gas inlet of Caldos27 can be connected to the sample gas output (gas path 1) of Uras26 at the factory or have a separate sample gas path without connection to Uras26.

... 4 Installation

... Position and design of the gas connections

Gas connections Uras26 with Caldos27 (model EL3040)

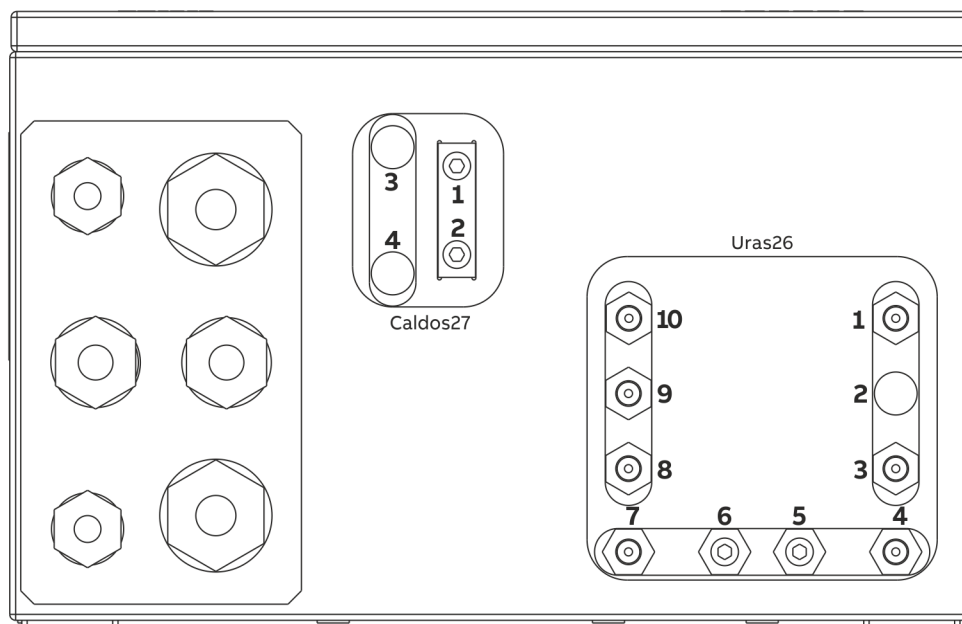

Figure 12: Gas connections Uras26 with Caldos27 (model EL3040)

Uras26: Gas connections

Pos.	Connection	Supplementary information	Version
1	Pressure sensor	The pressure sensor is connected to the Pos. 1 terminal if the internal gas lines are designed as stainless steel pipes, or if the 'Pressure sensor connected outside by hose' option is ordered.	<ul style="list-style-type: none"> • 1/8 NPT female thread (stainless steel 1.4305) • Connection of hose lines: straight screw-in socket (PP) with hose nozzles for hoses with inside diameter 4 mm (included in scope of delivery)
2	Not assigned	—	
3	Sample gas inlet (gas path 1)	—	<ul style="list-style-type: none"> • Connection of piping: screw-in fittings (not included in scope of delivery)
4	Sample gas outlet (gas path 1)	For a measuring cell and for two measuring cells with separate gas paths	
5	Purge gas inlet (housing)	—	
6	Purge gas outlet (housing)	—	
7	Sample gas inlet (gas path 2)	—	
8	Sample gas outlet (gas path 2)	—	
	Sample gas outlet (gas path 1)	For two sample cells in series	
9	Reference gas inlet	Sample cell 1 flowing reference gas	
10	Reference gas inlet		

Note

- The oxygen sensor is not possible in combination with Caldos27
- If the internal gas lines are designed as hoses, the pressure sensor (standard, not for the 'pressure sensor connected to outside by hose' option), and the oxygen sensor (option) are internally connected as follows:
 - In the output of measuring cell 1, for one measuring cell and for two measuring cells with separate gas paths.
 - In the output of measuring cells 2 for two measuring cells in series.
- If the internal gas lines are designed as stainless steel pipes, the version with separate gas paths is not possible.

Caldos27: Gas Connections

Pos.	Connection	Supplementary information	Version
1	Sample gas inlet	—	½ NPT female thread (stainless steel 1.4305)
2	Sample gas outlet	—	• Connection of hose lines:
3	not used	—	straight screw-in socket (PP) with hose nozzles
4	not used	—	for hoses with inside diameter 4 mm (included in scope of delivery)
			• Connection of piping: screw-in fittings (not included in scope of delivery)

Note

The sample gas inlet of Caldos27 can be connected to the sample gas output (gas path 1) of Uras26 at the factory or have a separate sample gas path without connection to Uras26.

... 4 Installation

... Position and design of the gas connections

Gas connections Limas23 (model EL3020)

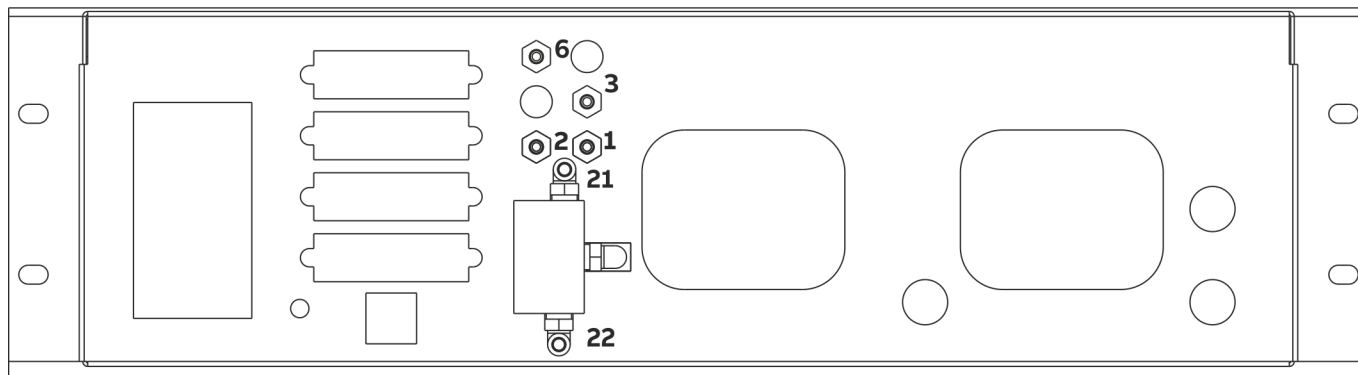

Figure 13: Gas connections Limas23 (model EL3020)

Limas23: Gas connections

Pos.	Connection	Supplementary information	Version
1	Sample gas inlet	Without optional solenoid valve	Screwed connections with hose nozzles (stainless steel 1.4305) for hoses with 4 mm inside diameter (included in scope of supply)
2	Sample gas outlet	—	
3	Sample gas outlet	With optional solenoid valve, factory-connected to sample gas input Pos. 1	
6	Pressure sensor	For 'Pressure sensor connected to the outside by hose' option	
21	Sample gas inlet	With optional solenoid valve	Screwed fittings with hose nozzles (PVDF) for hoses with 4 mm inside diameter (included in scope of supply)
22	Test gas inlet		

Note

The pressure sensor (standard, not for the 'pressure sensor connected to outside by hose' option), and the oxygen sensor (option) are internally connected in the outlet of the sample cell.

Gas connections Limas23 (model EL3040)

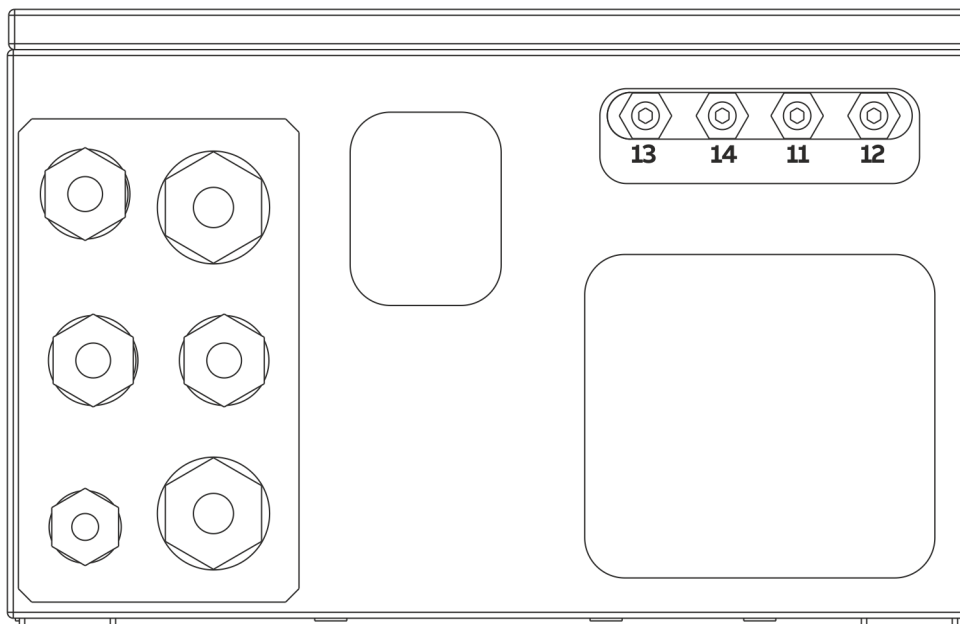

Figure 14: Gas connections Limas23 (model EL3040)

Limas23: Gas connections

Pos.	Connection	Supplementary information	Version
13	Sample gas inlet	—	½ NPT female thread (stainless steel 1.4305)
14	Sample gas outlet	—	• Connection of hose lines:
11	Pressure sensor	For 'Pressure sensor connected to the outside by hose' option	straight screw-in socket (PP) with hose nozzles for hoses with inside diameter 4 mm (included in scope of delivery)
	Purge gas inlet (housing)	Not for 'Pressure sensor connected to the outside by hose' option	• Connection of piping:
12	Purge gas outlet (housing)	Not for 'Pressure sensor connected to the outside by hose' option	screw-in fittings (not included in scope of delivery)

Note

The pressure sensor (standard, not for the 'pressure sensor connected to outside by hose' option), and the oxygen sensor (option) are internally connected in the outlet of the sample cell.

... 4 Installation

... Position and design of the gas connections

Gas connections Limas23 with Magnos206 (model EL3020)

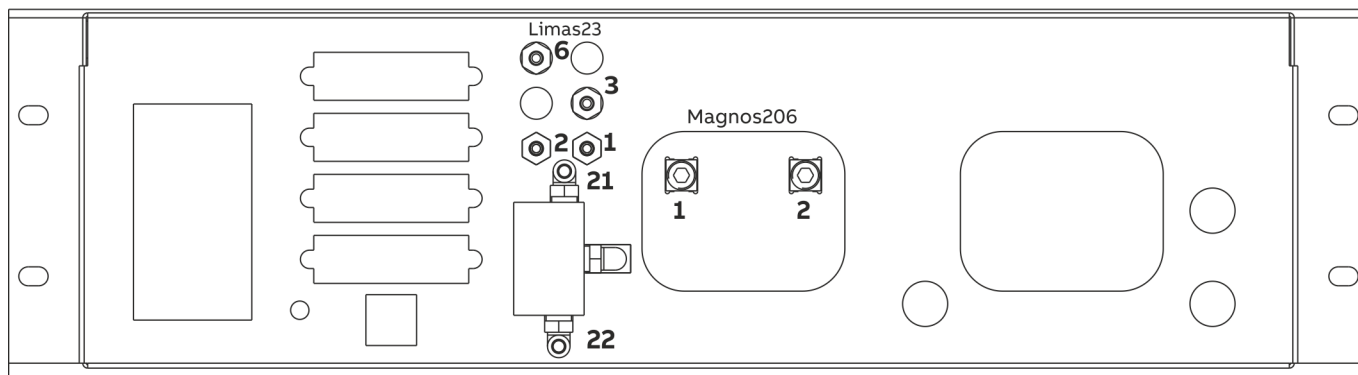

Figure 15: Gas connections Limas23 with Magnos206 (model EL3020)

Limas23: Gas connections

Pos.	Connection	Supplementary information	Version
1	Sample gas inlet	Without optional solenoid valve	Screwed connections with hose nozzles (stainless steel 1.4305) for hoses with 4 mm inside diameter
2	Sample gas outlet	—	(included in scope of supply)
3	Sample gas outlet	With optional solenoid valve, factory-connected to sample gas inlet Pos. 1	
6	Pressure sensor	For 'Pressure sensor connected to the outside by hose' option	
21	Sample gas inlet	With optional solenoid valve	Screwed fittings with hose nozzles (PVDF) for hoses with 4 mm inside diameter
22	Test gas inlet		(included in scope of supply)

Note

- The oxygen sensor is not possible in combination with Magnos206
- The pressure sensor (default, not used with the "pressure sensor outwards" option is internally connected at the output of the sample cell.

Magnos206: Gas Connections

Pos.	Connection	Supplementary information	Version
1	Sample gas inlet	—	½ NPT female thread (stainless steel 1.4305)
2	Sample gas outlet	—	<ul style="list-style-type: none"> • Connection of hose lines: straight screw-in socket (PP) with hose nozzles for hoses with inside diameter 4 mm (included in scope of delivery) • Connection of piping: screw-in fittings (not included in scope of delivery)

Note

The sample gas inlet of Magnos206 can be connected to the sample gas output of Limas23 at the factory or have a separate sample gas path without connection to Limas23.

Gas connections Limas23 with Magnos206 (model EL3040)

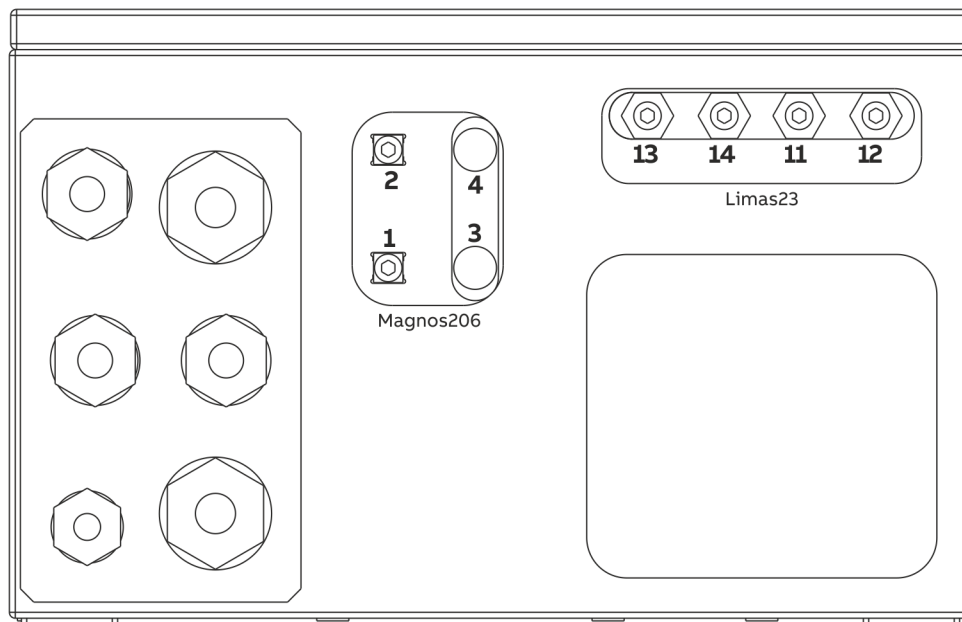

Figure 16: Gas connections Limas23 with Magnos206 (model EL3040)

Limas23: Gas connections

Pos.	Connection	Supplementary information	Version
13	Sample gas inlet	—	½ NPT female thread (stainless steel 1.4305)
14	Sample gas outlet	—	• Connection of hose lines:
11	Pressure sensor	For 'Pressure sensor connected to the outside by hose' option	straight screw-in socket (PP) with hose nozzles for hoses with inside diameter 4 mm (included in scope of delivery)
	Purge gas inlet (housing)	Not for 'Pressure sensor connected to the outside by hose' option	
12	Purge gas outlet (housing)	option	• Connection of piping: screw-in fittings (not included in scope of delivery)

Note

- The oxygen sensor is not possible in combination with Magnos206
- The pressure sensor (default, not used with the "pressure sensor outwards" option is internally connected at the output of the sample cell.

... 4 Installation

... Position and design of the gas connections

Magnos206: Gas Connections

Pos.	Connection	Supplementary information	Version
1	Sample gas inlet	—	½ NPT female thread (stainless steel 1.4305)
2	Sample gas outlet	—	<ul style="list-style-type: none"> • Connection of hose lines: straight screw-in socket (PP) with hose nozzles for hoses with inside diameter 4 mm (included in scope of delivery) • Connection of piping: screw-in fittings (not included in scope of delivery)
3	Not assigned	—	
4	Not assigned	—	

Note

The sample gas inlet of Magnos206 can be connected to the sample gas output of Limas23 at the factory or have a separate sample gas path without connection to Limas23.

Gas connections Limas23 with Magnos28 (model EL3020)

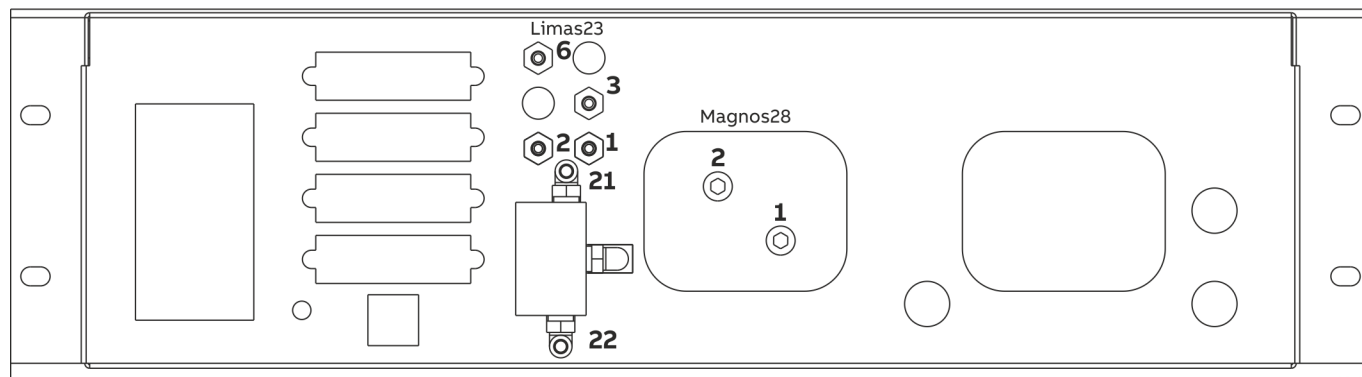

Figure 17: Gas connections Limas23 with Magnos28 (model EL3020)

Limas23: Gas connections

Pos.	Connection	Supplementary information	Version
1	Sample gas inlet	Without optional solenoid valve	Screwed connections with hose nozzles (stainless steel 1.4305) for hoses with 4 mm inside diameter
2	Sample gas outlet	—	(included in scope of supply)
3	Sample gas outlet	With optional solenoid valve, factory-connected to sample gas inlet Pos. 1	
6	Pressure sensor	For 'Pressure sensor connected to the outside by hose' option	
21	Sample gas inlet	With optional solenoid valve	Screwed fittings with hose nozzles (PVDF) for hoses with 4 mm inside diameter
22	Test gas inlet		(included in scope of supply)

Note

- The oxygen sensor is not possible in combination with Magnos28
- The pressure sensor (default, not used with the "pressure sensor outwards" option is internally connected at the output of the sample cell.

Magnos28: Gas Connections

Pos.	Connection	Supplementary information	Version
1	Sample gas inlet	—	½ NPT female thread (stainless steel 1.4305)
2	Sample gas outlet	—	<ul style="list-style-type: none"> • Connection of hose lines: straight screw-in socket (PP) with hose nozzles for hoses with inside diameter 4 mm (included in scope of delivery) • Connection of piping: screw-in fittings (not included in scope of delivery)

Note

The sample gas inlet of Magnos28 can be connected to the sample gas output of Limas23 at the factory or have a separate sample gas path without connection to Limas23.

... 4 Installation

... Position and design of the gas connections

Gas connections Limas23 with Magnos28 (model EL3040)

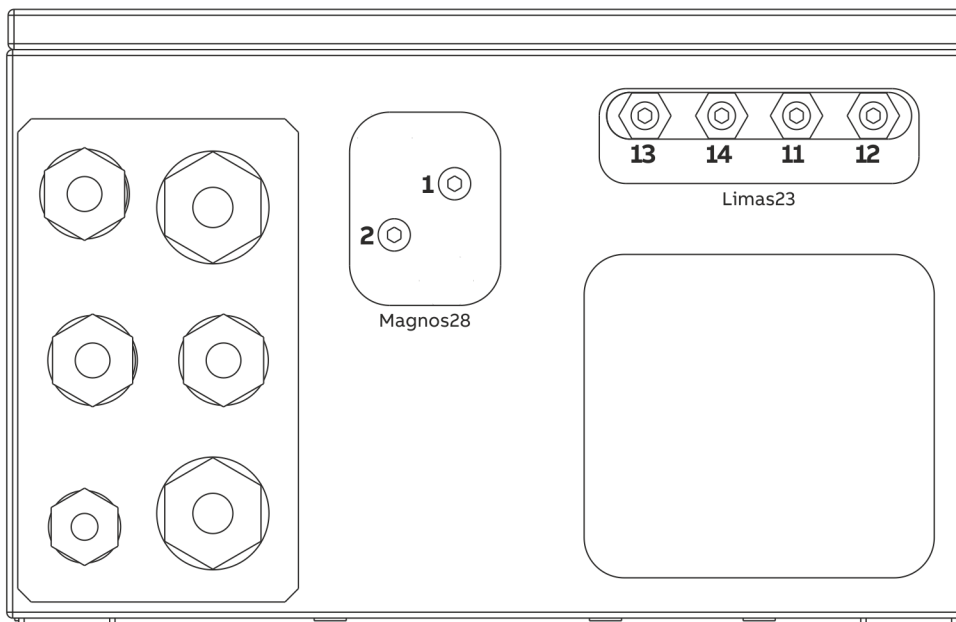

Figure 18: Gas connections Limas23 with Magnos28 (model EL3040)

Limas23: Gas connections

Pos.	Connection	Supplementary information	Version
13	Sample gas inlet	—	½ NPT female thread (stainless steel 1.4305)
14	Sample gas outlet	—	• Connection of hose lines:
11	Pressure sensor	For 'Pressure sensor connected to the outside by hose' option	straight screw-in socket (PP) with hose nozzles for hoses with inside diameter 4 mm (included in scope of delivery)
	Purge gas inlet (housing)	Not for 'Pressure sensor connected to the outside by hose' option	
12	Purge gas outlet (housing)	option	• Connection of piping: screw-in fittings (not included in scope of delivery)

Note

- The oxygen sensor is not possible in combination with Magnos28
- The pressure sensor (default, not used with the "pressure sensor outwards" option is internally connected at the output of the sample cell.

Magnos28: Gas Connections

Pos.	Connection	Supplementary information	Version
1	Sample gas inlet	—	½ NPT female thread (stainless steel 1.4305)
2	Sample gas outlet	—	<ul style="list-style-type: none"> • Connection of hose lines: straight screw-in socket (PP) with hose nozzles for hoses with inside diameter 4 mm (included in scope of delivery) • Connection of piping: screw-in fittings (not included in scope of delivery)

Note

The sample gas inlet of Magnos28 can be connected to the sample gas output of Limas23 at the factory or have a separate sample gas path without connection to Limas23.

... 4 Installation

... Position and design of the gas connections

Gas connections Magnos206 (model EL3020)

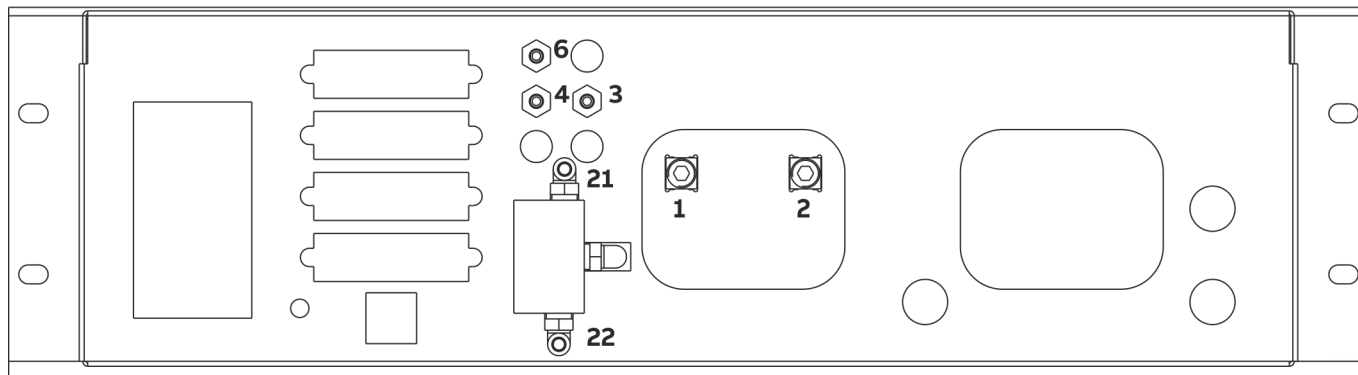

Figure 19: Gas connections Magnos206 (model EL3020)

Magnos206: Gas Connections

Pos.	Connection	Supplementary information	Version
1	Sample gas inlet	—	1/8 NPT female thread (stainless steel 1.4305) <ul style="list-style-type: none"> • Connection of hose lines: straight screw-in socket (PP) with hose nozzles for hoses with inside diameter 4 mm (included in scope of delivery) • Connection of piping: screw-in fittings (not included in scope of delivery)
2	Sample gas outlet	—	Screwed connections with hose nozzles (stainless steel 1.4305) for hoses with 4 mm inside diameter (included in scope of supply)
3	Sample gas outlet	For 'Integrated gas feed' option, factory-connected to 1 sample gas inlet	Screwed connections with hose nozzles (stainless steel 1.4305) for hoses with 4 mm inside diameter (included in scope of supply)
4	Sample gas inlet	For 'Integrated gas feed' option with flow sensor only (without solenoid valve)	Screwed connections with hose nozzles (stainless steel 1.4305) for hoses with 4 mm inside diameter (included in scope of supply)
6	Pressure sensor	—	
21	Sample gas inlet	On solenoid valve with 'integral gas feed' option with solenoid valve, pump, filter, capillary and flow sensor	Screwed fittings with hose nozzles (PVDF) for hoses with 4 mm inside diameter (included in scope of supply)
22	Test gas inlet	—	Screwed fittings with hose nozzles (PVDF) for hoses with 4 mm inside diameter (included in scope of supply)

Note

The pressure sensor (see **Pressure sensor** on page 33) is installed as an option.

For a precise pressure correction as well as for measurements in suppressed measuring ranges, the sensor and sample gas outlet have to be connected to each other via a T-piece and with the use of short conductors.

The lines must be as short as possible or – in the case of a greater length – have a sufficiently large inside diameter (min. 10 mm) so that the flow effect is minimized.

Gas connections Magnos206 (model EL3040)

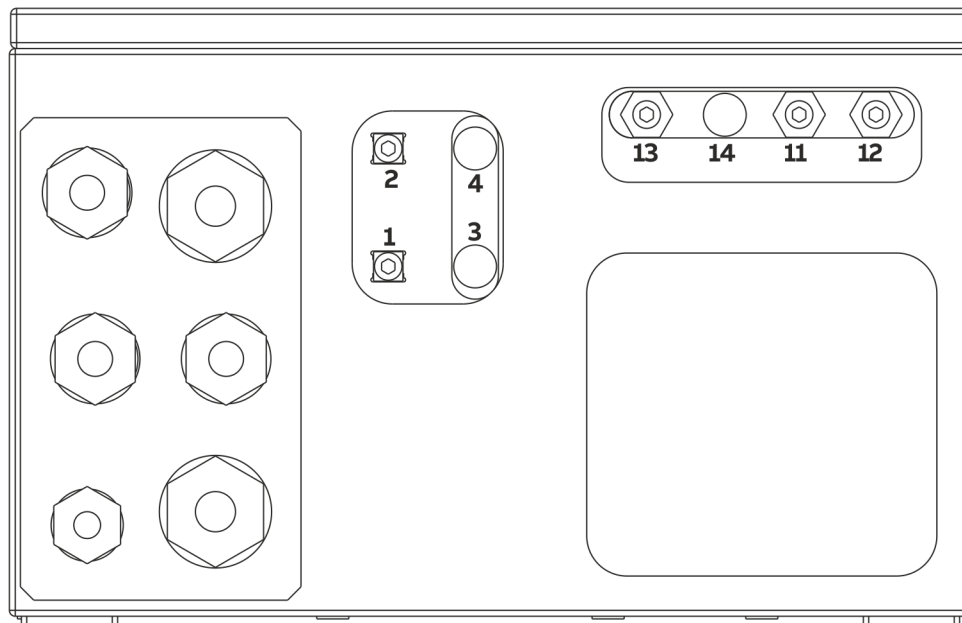

Figure 20: Gas connections Magnos206 (model EL3040)

Magnos206: Gas Connections

Pos.	Connection	Supplementary information	Version
1	Sample gas inlet	—	1/8 NPT female thread (stainless steel 1.4305)
2	Sample gas outlet	—	<ul style="list-style-type: none"> • Connection of hose lines: straight screw-in socket (PP) with hose nozzles for hoses with inside diameter 4 mm (included in scope of delivery) • Connection of piping: screw-in fittings (not included in scope of delivery)
3	Not assigned	—	
4	Not assigned	—	
11	Purge gas inlet (housing)	—	
12	Purge gas outlet (housing)	—	
13	Pressure sensor	—	
14	Not assigned	—	

Note

The pressure sensor (see **Pressure sensor** on page 33) is installed as an option.

For a precise pressure correction as well as for measurements in suppressed measuring ranges, the sensor and sample gas outlet have to be connected to each other via a T-piece and with the use of short conductors.

The lines must be as short as possible or – in the case of a greater length – have a sufficiently large inside diameter (min. 10 mm) so that the flow effect is minimized.

... 4 Installation

... Position and design of the gas connections

Gas connections Magnos28 (model EL3020)

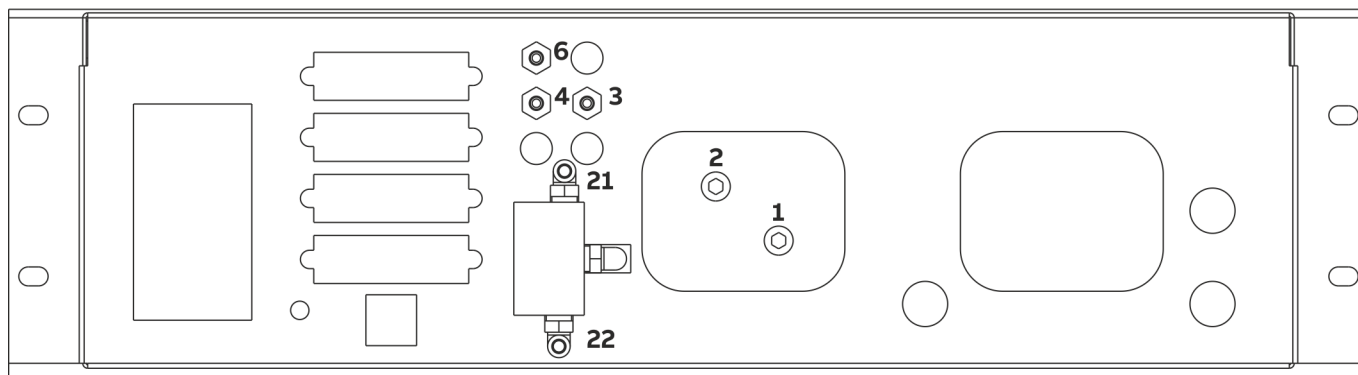

Figure 21: Gas connections Magnos28 (model EL3020)

Magnos28: Gas Connections

Pos.	Connection	Supplementary information	Version
1	Sample gas inlet	—	1/8 NPT female thread (stainless steel 1.4305)
2	Sample gas outlet	—	<ul style="list-style-type: none"> • Connection of hose lines: straight screw-in socket (PP) with hose nozzles for hoses with inside diameter 4 mm (included in scope of delivery) • Connection of piping: screw-in fittings (not included in scope of delivery)
3	Sample gas outlet	For 'Integrated gas feed' option, factory-connected to sample gas inlet Pos. 1	Screwed connections with hose nozzles (stainless steel 1.4305) for hoses with 4 mm inside diameter (included in scope of supply)
4	Sample gas inlet	For 'Integrated gas feed' option with flow sensor only (without solenoid valve)	
6	Pressure sensor	—	
21	Sample gas inlet	On solenoid valve with 'integral gas feed' option	Screwed fittings with hose nozzles (PVDF) for hoses with 4 mm inside diameter
22	Test gas inlet	with solenoid valve, pump, filter, capillary and flow sensor	(included in scope of supply)

Note

The pressure sensor (see **Pressure sensor** on page 33) is installed as an option.

For a precise pressure correction as well as for measurements in suppressed measuring ranges, the sensor and sample gas outlet have to be connected to each other via a T-piece and with the use of short conductors.

The lines must be as short as possible or – in the case of a greater length – have a sufficiently large inside diameter (min. 10 mm) so that the flow effect is minimized.

Gas connections Magnos28 with Magnos28 (model EL3020)

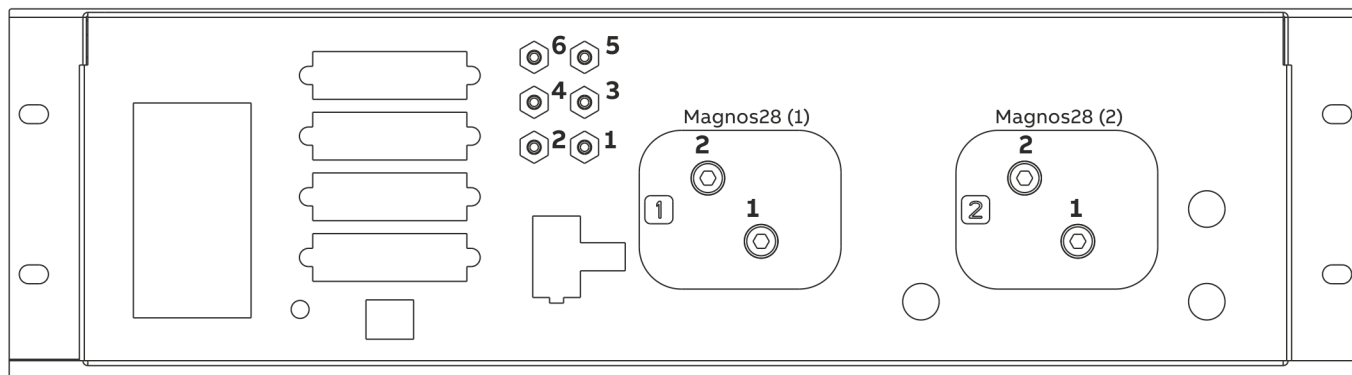

Figure 22: Gas connections Magnos28 with Magnos28 (model EL3020)

Magnos28 – gas connections for direct connection (applies to both analyzer modules)

Pos.	Connection	Supplementary information	Version
1	Sample gas inlet	—	½ NPT female thread (stainless steel 1.4305)
2	Sample gas outlet	—	Connection of hose lines: straight screw-in socket (PP) with hose nozzles for hoses with inside diameter 4 mm (included in scope of delivery)
5	Pressure sensor (option)	For analyzer module (2), not for flammable sample gases	Screwed connections with hose nozzles (stainless steel 1.4305) for hoses with 4 mm inside diameter
6	Pressure sensor (option)	For analyzer module (1). For flammable sample gases: Common sensor for analyzer module (1) and analyzer module (2). Caution Do not connect the pressure sensor in the sample gas path!	(included in scope of supply)

Magnos28 with Magnos28 – gas connections with 'Integral gas feed' option with flow sensor

Pos.	Connection	Supplementary information	Version
1	Sample gas output (gas path 1 / module 1)	Factory-connected to analyzer module (1) sample gas inlet 1	Screwed connections with hose nozzles (stainless steel 1.4305) for hoses with 4 mm inside diameter (included in scope of supply)
2	Sample gas inlet (gas path 1 / module 1)	—	
3	Sample gas output (gas path 2 / module 2)	Factory-connected to analyzer module (2) sample gas inlet 1	
4	Sample gas inlet (gas path 2 / module 2)	—	
5	Pressure sensor (option)	For analyzer module (2)	
6	Pressure sensor (option)	For analyzer module (1)	

... 4 Installation

... Position and design of the gas connections

Gas connections Magnos28 with Caldos27 (model EL3020)

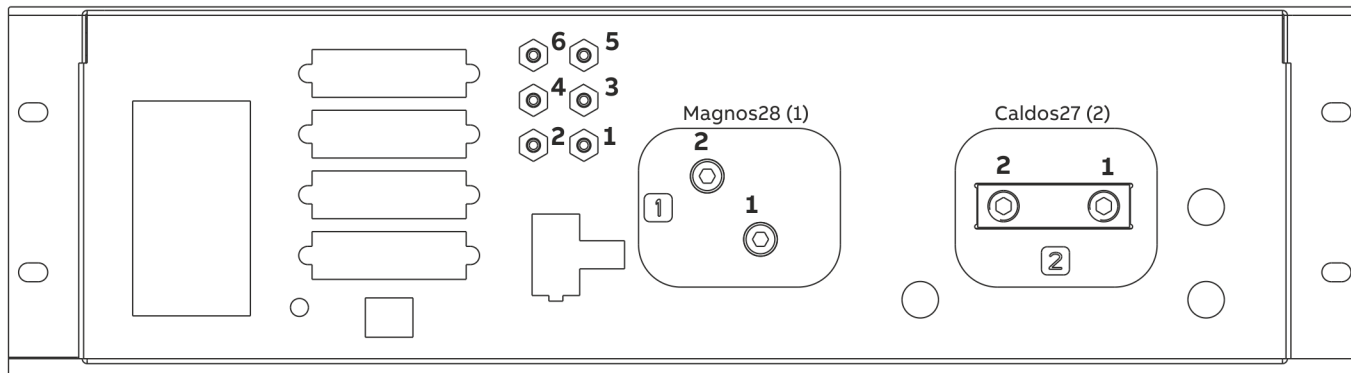

Figure 23: Gas connections Magnos28 with Caldos27 (model EL3020)

Magnos28 – gas connections for direct connection

Pos.	Connection	Supplementary information	Version
1	Sample gas inlet	—	½ NPT female thread (stainless steel 1.4305)
2	Sample gas outlet	—	Connection of hose lines: straight screw-in socket (PP) with hose nozzles for hoses with inside diameter 4 mm (included in scope of delivery)
6	Pressure sensor (option)	For flammable sample gases: common sensor for Magnos28 and Caldos27. Caution Do not connect the pressure sensor in the sample gas path!	Screwed connections with hose nozzles (stainless steel 1.4305) for hoses with 4 mm inside diameter (included in scope of supply)

Caldos27 – gas connections for direct connection

Pos.	Connection	Supplementary information	Version
1	Sample gas inlet	—	½ NPT female thread (stainless steel 1.4305)
2	Sample gas outlet	—	Connection of hose lines: straight screw-in socket (PP) with hose nozzles for hoses with inside diameter 4 mm (included in scope of delivery)
5	Pressure sensor	Not for flammable sample gases	straight screw-in socket (PP) with hose nozzles for hoses with inside diameter 4 mm (included in scope of delivery)
6	Pressure sensor	For flammable sample gases: common sensor for Magnos28 and Caldos27. Caution Do not connect the pressure sensor in the sample gas path!	straight screw-in socket (PP) with hose nozzles for hoses with inside diameter 4 mm (included in scope of delivery)

Magnos28 with Caldos27 – gas connections for ‘Integral gas feed’ option with flow sensor

Pos.	Connection	Supplementary information	Version
1	Sample gas outlet (gas path 1 / Magnos28)	Factory-connected to Magnos28 sample gas inlet 1	Screwed connections with hose nozzles (stainless steel 1.4305) for hoses with 4 mm inside diameter (included in scope of supply)
2	Sample gas inlet (gas path 1 / Magnos28)	—	
3	Sample gas outlet (gas path 2 / Caldos27)	Factory-connected to Caldos27 sample gas inlet 1	
4	Sample gas inlet (gas path 2 / Caldos27)	—	
5	Pressure sensor	For Caldos27	
6	Pressure sensor (option)	For Magnos28	

... 4 Installation

... Position and design of the gas connections

Gas connections Magnos28 (model EL3040)

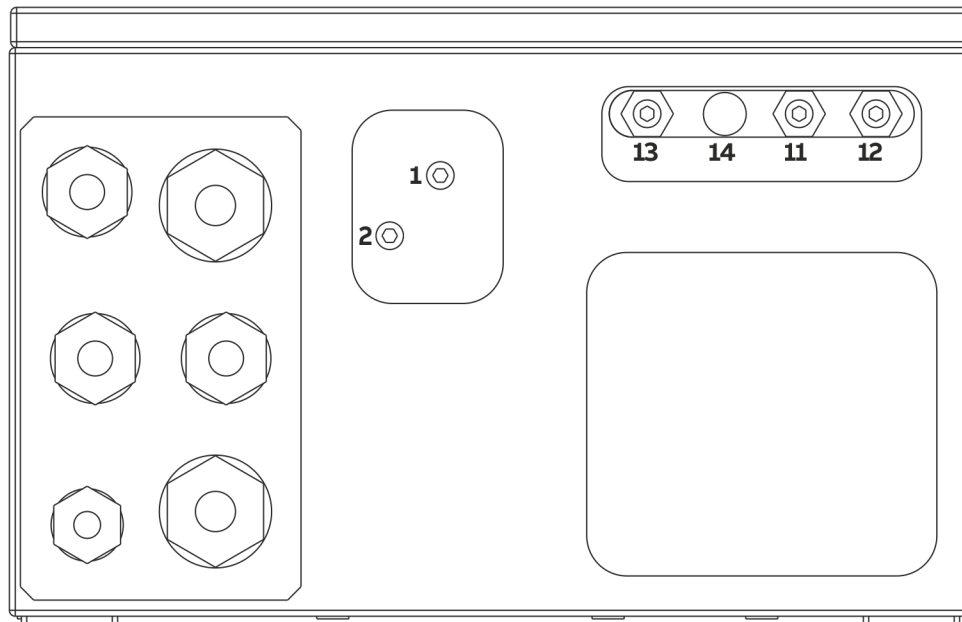

Figure 24: Gas connections Magnos28 (model EL3040)

Magnos28: Gas Connections

Pos.	Connection	Supplementary information	Version
1	Sample gas inlet	—	½ NPT female thread (stainless steel 1.4305)
2	Sample gas outlet	—	• Connection of hose lines:
11	Purge gas inlet (housing)	—	straight screw-in socket (PP) with hose nozzles
12	Purge gas outlet (housing)	—	for hoses with inside diameter 4 mm
13	Pressure sensor	—	(included in scope of delivery)
14	Not assigned	—	• Connection of piping:
			screw-in fittings
			(not included in scope of delivery)

Note

The pressure sensor (see **Pressure sensor** on page 33) is installed as an option.

For a precise pressure correction as well as for measurements in suppressed measuring ranges, the sensor and sample gas outlet have to be connected to each other via a T-piece and with the use of short conductors.

The lines must be as short as possible or – in the case of a greater length – have a sufficiently large inside diameter (min. 10 mm) so that the flow effect is minimized.

Gas connections Magnos27 (model EL3020)

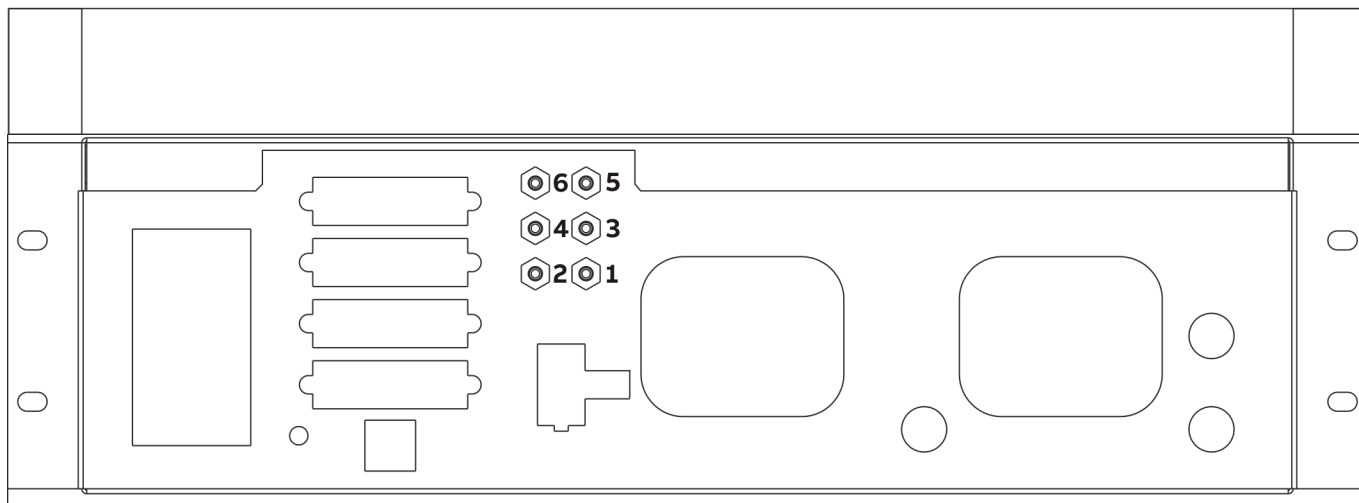

Figure 25: Gas connections Magnos27 (model EL3020)

Magnos27: Gas Connections

Pos.	Connection	Supplementary information	Version
1	Pressure sensor	—	Screwed connections with hose nozzles (stainless steel 1.4305) for hoses with 4 mm inside diameter (included in scope of supply)
2	Not assigned	—	
3	Sample gas inlet	—	
4	Sample gas outlet	—	
5	Purge gas inlet analyzer	—	
6	Purge gas outlet analyzer	—	

Note

The pressure sensor (see **Pressure sensor** on page 33) is installed as an option.

For a precise pressure correction as well as for measurements in suppressed measuring ranges, the sensor and sample gas outlet have to be connected to each other via a T-piece and with the use of short conductors.

The lines must be as short as possible or – in the case of a greater length – have a sufficiently large inside diameter (min. 10 mm) so that the flow effect is minimized.

... 4 Installation

... Position and design of the gas connections

Gas connections Magnos27 with Uras26 (model EL3020)

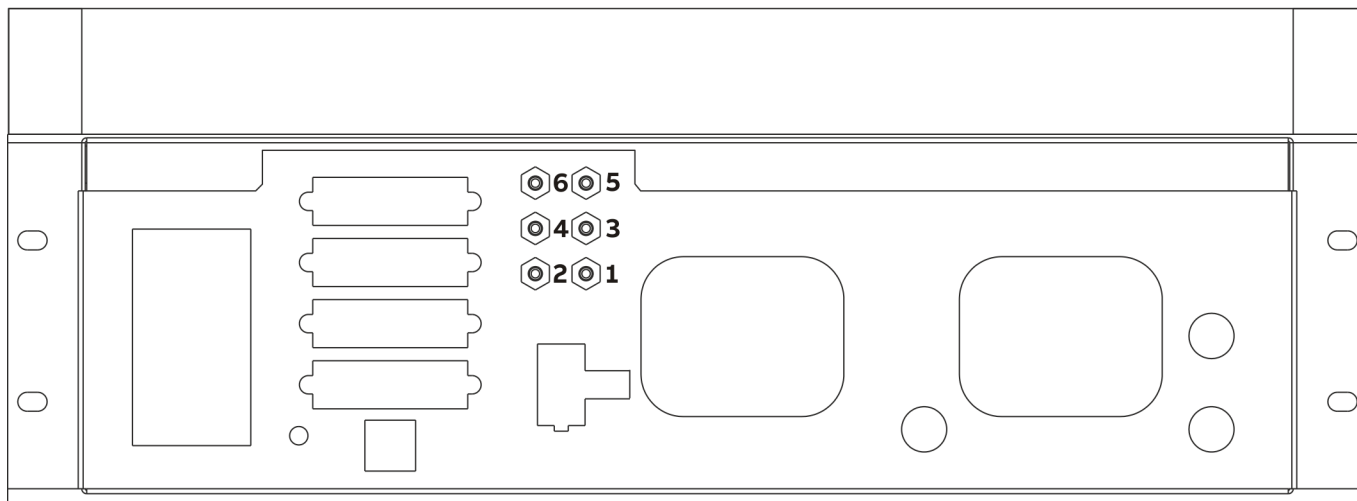

Figure 26: Gas connections Magnos27 with Uras26 (model EL3020)

Magnos27: Gas Connections

Pos.	Connection	Supplementary information	Version
3	Sample gas inlet	—	Screwed connections with hose nozzles (stainless steel 1.4305) for hoses with 4 mm inside diameter (included in scope of supply)
4	Sample gas outlet	—	
5	Purge gas inlet analyzer	Not for the 'pressure sensor connected to the outside by hose' option, not in combination with Uras26 with two cells and separate gas paths	(included in scope of supply)
6	Purge gas outlet analyzer	For the 'pressure sensor connected to the outside by hose' option, not in combination with Uras26 with two cells and separate gas paths	

Uras26: Gas connections

Pos.	Connection	Supplementary information	Version
1	Sample gas inlet (gas path 1)	—	Screwed connections with hose nozzles (stainless steel 1.4305) for hoses with 4 mm inside diameter (included in scope of supply)
2	Sample gas outlet (gas path 1)	—	
5	Sample gas outlet (gas path 2)	For optional second sample gas for Uras26 with two cells and separate gas paths	
6	Sample gas inlet (gas path 2)		

Note

The pressure sensor (standard, not for the 'pressure sensor connected to outside by hose' option) is internally connected as follows:

- In the output of the sample cell 1, for a sample cell and for two sample cells with separate gas paths.
- In the output of sample cell 2 for two sample cells in series.

Gas connections Z023 (model EL3020)

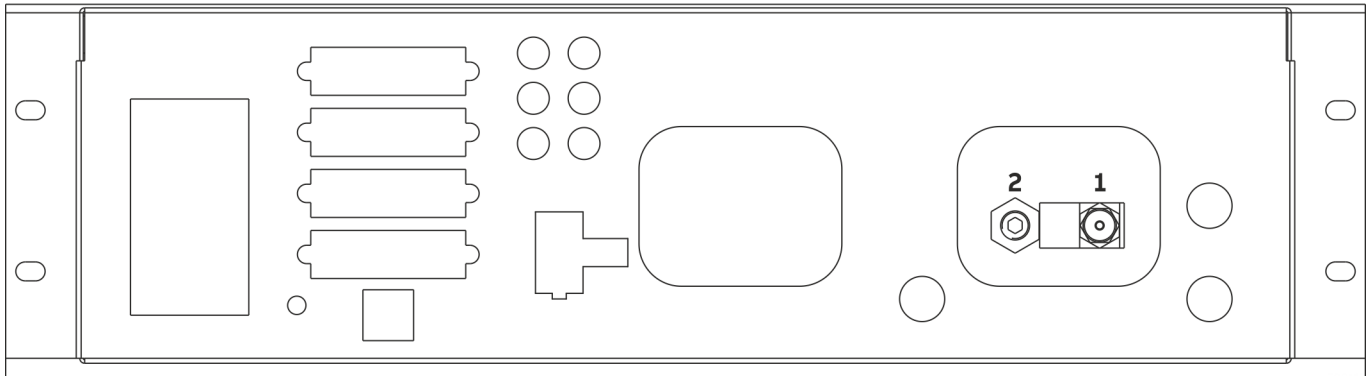

Figure 27: Gas connections Z023 (Model EL3020)

Z023: Gas Connections

The measuring chamber is connected to the sample gas inlet connection via a stainless steel tube (inlet side) and to the sample gas outlet connection via a FPM hose (outlet side).

Pos.	Connection	Supplementary information	Version
1	Sample gas inlet	—	3 mm Swagelok®
2	Sample gas outlet	—	1/8 NPT female thread for threaded connections (not included in scope of supply)

... 4 Installation

... Position and design of the gas connections

Gas connections ZO23 (model EL3040)

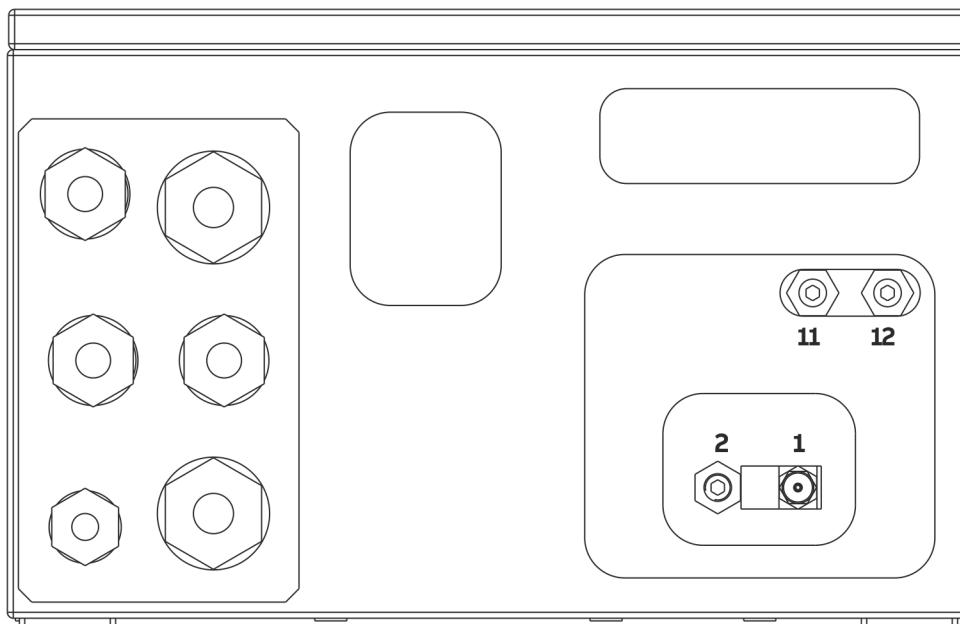

Figure 28: Gas connections ZO23 (model EL3040)

ZO23: Gas Connections

The measuring chamber is connected to the sample gas inlet connection via a stainless steel tube (inlet side) and to the sample gas outlet connection via a FPM hose (outlet side).

Pos.	Connection	Supplementary information	Version
1	Sample gas inlet	—	3 mm Swagelok®
2	Sample gas outlet	—	1/8 NPT female thread for threaded connections
11	Purge gas inlet (housing)	—	(not included in scope of supply)
12	Purge gas outlet (housing)	—	

Gas connections Caldos27 (model EL3020)

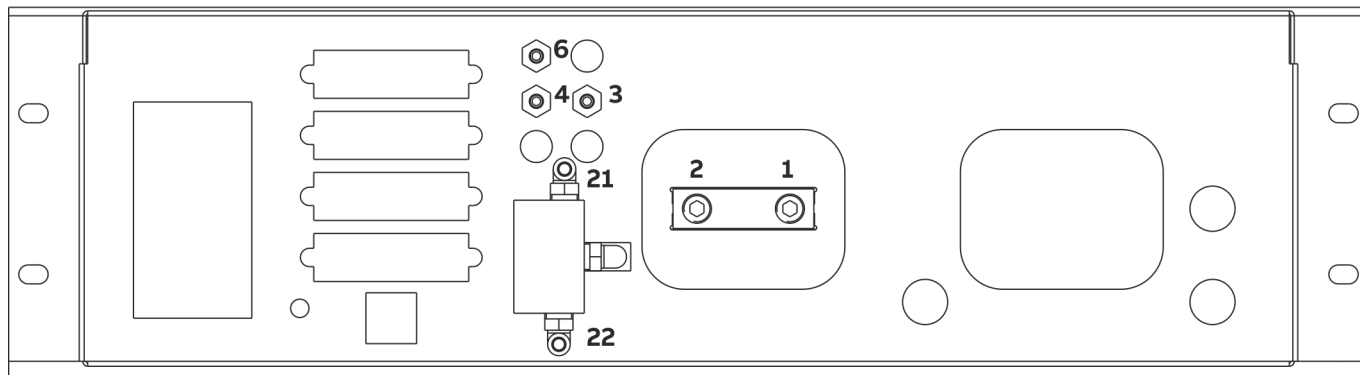

Figure 29: Gas connections Caldos27 (model EL3020)

Caldos27: gas connections

Pos.	Connection	Supplementary information	Version
1	Sample gas inlet	—	½ NPT female thread (stainless steel 1.4305) <ul style="list-style-type: none"> • Connection of hose lines: straight screw-in socket (PP) with hose nozzles for hoses with inside diameter 4 mm (included in scope of delivery) • Connection of piping: screw-in fittings (not included in scope of delivery)
2	Sample gas outlet	—	Screwed connections with hose nozzles (stainless steel 1.4305) for hoses with 4 mm inside diameter (included in scope of supply)
3	Sample gas outlet	For 'Integrated gas feed' option, factory-connected to 1 sample gas inlet	Screwed connections with hose nozzles (stainless steel 1.4305) for hoses with 4 mm inside diameter (included in scope of supply)
4	Sample gas inlet	For 'Integrated gas feed' option with flow sensor only (without solenoid valve)	Screwed connections with hose nozzles (stainless steel 1.4305) for hoses with 4 mm inside diameter (included in scope of supply)
6	Pressure sensor	—	
21	Sample gas inlet	On solenoid valve with 'integral gas feed' option	Screwed fittings with hose nozzles (PVDF) for hoses with 4 mm inside diameter (included in scope of supply)
22	Test gas inlet	with solenoid valve, pump, filter, capillary and flow sensor	Screwed fittings with hose nozzles (PVDF) for hoses with 4 mm inside diameter (included in scope of supply)

... 4 Installation

... Position and design of the gas connections

Gas connections Caldos27 with Caldos27 (model EL3020)

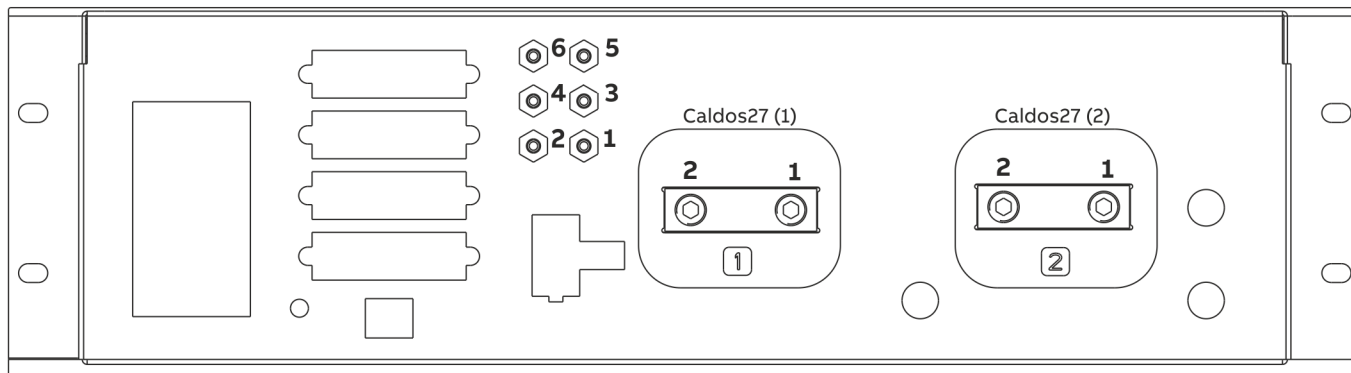

Figures 30: Gas connections Caldos27 with Caldos27 (model EL3020)

Caldos27 – gas connections for direct connection (applicable for both analyzer modules)

Pos.	Connection	Supplementary information	Version
1	Sample gas inlet	—	½ NPT female thread (stainless steel 1.4305) Connection of hose lines:
2	Sample gas outlet	—	straight screw-in socket (PP) with hose nozzles for hoses with inside diameter 4 mm (included in scope of delivery)
5	Pressure sensor	For analyzer module (2), not for flammable sample gases	Screwed connections with hose nozzles (stainless steel 1.4305) for hoses with 4 mm inside diameter
6	Pressure sensor	For analyzer module (1), for flammable sample gases: Common sensor for analyzer module (1) and analyzer module (2). Caution Do not connect the pressure sensor in the sample gas path!	(included in scope of supply)

Caldos27 with Caldos27 – gas connections for 'Integral gas feed' option with flow sensor

Pos.	Connection	Supplementary information	Version
1	Sample gas output (gas path 1 / module 1)	Factory-connected to analyzer module (1) sample gas inlet 1	Screwed connections with hose nozzles (stainless steel 1.4305) for hoses with 4 mm inside diameter (included in scope of supply)
2	Sample gas inlet (gas path 1 / module 1)	—	
3	Sample gas output (gas path 2 / module 2)	Factory-connected to analyzer module (2) sample gas inlet 1	
4	Sample gas inlet (gas path 2 / module 2)	—	
5	Pressure sensor	For analyzer module (2)	
6	Pressure sensor	For analyzer module (1)	

Gas connections Caldos27 (model EL3040)

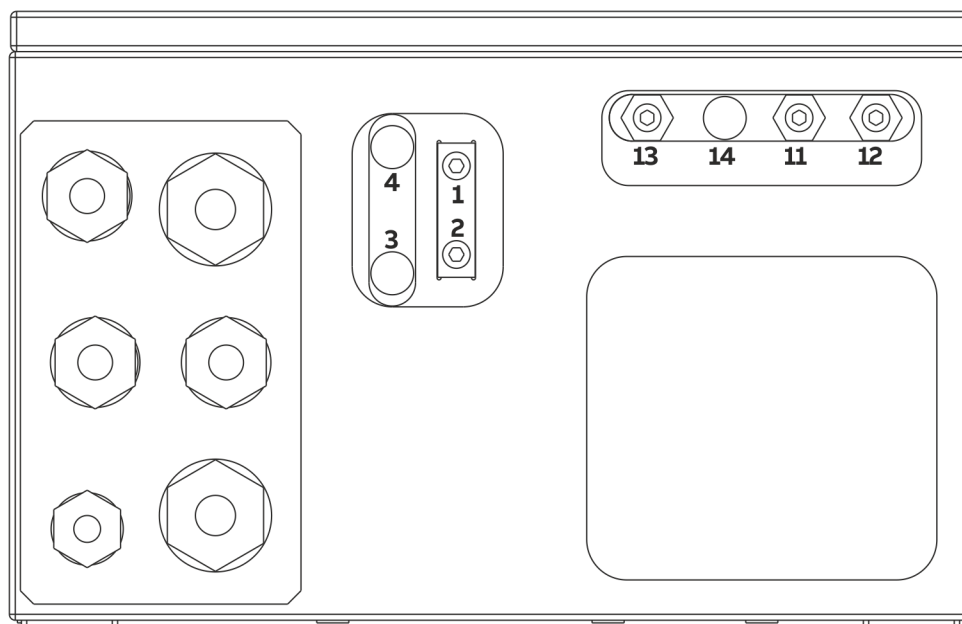

Figure 31: Gas connections Caldos27 (model EL3040)

Caldos27: gas connections

Pos.	Connection	Supplementary information	Version
1	Sample gas inlet	—	½ NPT female thread (stainless steel 1.4305)
2	Sample gas outlet	—	• Connection of hose lines:
3	Not assigned	—	straight screw-in socket (PP) with hose nozzles
4	Not assigned	—	for hoses with inside diameter 4 mm
11	Purge gas inlet (housing)	—	(included in scope of delivery)
12	Purge gas outlet (housing)	—	• Connection of piping:
13	Pressure sensor	—	screw-in fittings
14	Not assigned	—	(not included in scope of delivery)

... 4 Installation

... Position and design of the gas connections

Gas connections and electrical connections Fidas24 (model EL3020)

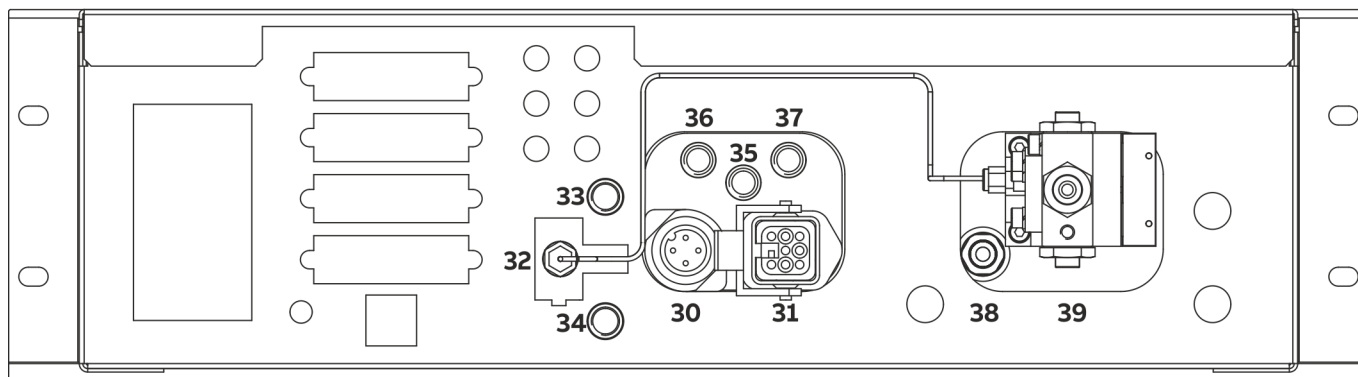

Figure 32: Gas connections and electric connections Fidas24 (model EL3020)

Fidas24: Gas and electrical connections

Pos.	Connection	Supplementary information	Version
30	Power supply (input)	115 V AC or 230 V AC for heating the detector and sample gas inlet	4-pin male connector, connection cable included in scope of supply
31	Power supply (output)	Electrical connection to the heated sample gas connection	Permanently connected
32	Test gas outlet	—	1/8 NPT female thread for threaded connections (not included in scope of supply)
33	Zero-point gas inlet	—	
34	End-point gas inlet	—	
35	Combustion air inlet	—	
36	Combustion gas inlet	—	
37	Instrument air inlet	—	
38	Exhaust outlet	—	Male thread for connection of the exhaust air pipe (stainless steel tube with an outside diameter of 6 mm, included in the scope of supply of the gas analyzer)
39	Sample gas inlet	Heated or unheated	Threaded connection for PTFE or stainless steel tubing with a 6 mm outer diameter

Gas connections and electrical connections Fidas24 (model EL3040)

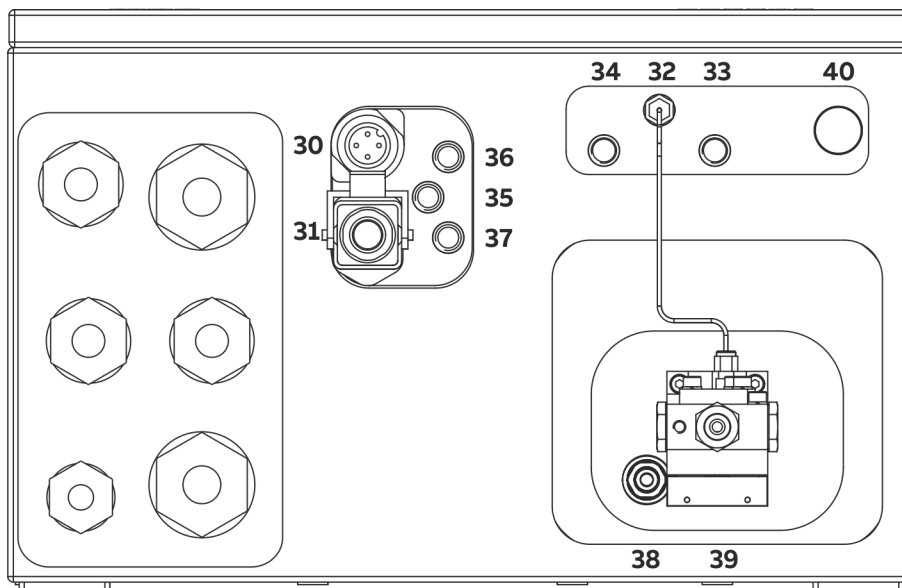

Figure 33: Gas connections and electrical connections Fidas24 (model EL3040)

Fidas24: Gas and electrical connections

Pos.	Connection	Supplementary information	Version
30	Power supply (input)	115 V AC or 230 V AC for heating the detector and sample gas inlet	4-pin male connector, connection cable included in scope of supply
31	Power supply (output)	Electrical connection to the heated sample gas connection	Permanently connected
32	Test gas outlet	—	1/8 NPT female thread for threaded connections
33	Zero-point gas inlet	—	(not included in scope of supply)
34	End-point gas inlet	—	
35	Combustion air inlet	—	
36	Combustion gas inlet	—	
37	Instrument air inlet	—	
38	Exhaust outlet	—	Male thread for connection of the exhaust air pipe (stainless steel tube with an outside diameter of 6 mm, included in the scope of supply of the gas analyzer)
39	Sample gas inlet	Heated or unheated	Threaded connection for PTFE or stainless steel tubing with a 6 mm outer diameter
40	Pressure equalizing opening	With protective filter (the protective filter must be protected against humidity)	—

... 4 Installation

Gas Analyzer Installation

NOTICE

Damage to the device due to unsuited installation site

- The installation site must be sufficiently stable to support the weight of the gas analyzer (see **Housing design** on page 15)
- The 19" housing must be supported in the cabinet or on the rack with mounting rails!

CAUTION

Injury hazard due to heavy weight

Depending on the version, the gas analyzer weighs 7 to 15 kg (19" housing – model EL3020) or 13 to 21 kg (wall-mounted housing – model EL3040)!

- Two persons are required for unpacking and transportation!

Materials required (not included in the scope of delivery)

19" housing (model EL3020)

- 4 raised head screws (recommendation: M6; this depends on the cabinet/rack system)
- 1 pair mounting rails (design depending on the cabinet/frame system), length approx. 240 mm corresponding to approx. $\frac{2}{3}$ of the housing depth

Wall-mount housing (model EL3040)

- 4 screws M8 or M10

Gas Analyzer Installation

Mount the gas analyzer in the cabinet / rack or on the wall. Observe the dimension diagram (see **Dimensions** on page 35). Mount several 19" housings with a minimum distance of 1 HE between each housing,

Special conditions for the Fidas24 gas analyzer

If the gas analyzer is installed in a closed cabinet, adequate ventilation of the cabinet must be provided (at least 1 change of air per hour).

Special conditions for the model EL3020 gas analyzer for the measurement of flammable gases

Unrestricted exchange of air with the environment must be provided around the gas analyzer from the bottom (floor plate) and from the rear (gas connections).

The gas analyzer may not be placed directly on a table. The housing openings may not be closed. Spacing to adjacent built-in components to the sides must be at least 3 cm.

If the gas analyzer is installed in a closed cabinet, adequate ventilation of the cabinet must be provided (at least 1 change of air per hour).

The spacing to adjoining fittings from the bottom (floor plate) and from the back (gas connections) must be at least 3 cm.

Special conditions for the model EL3040 gas analyzer in degree of protection II 3G

Protection against mechanical influences

Due to the low mechanical stability of the viewing glass, the gas analyzer must be designed and operated in such a way that mechanical damage to the viewing glass is excluded with an energy greater than 2 J.

UV radiation protection

Due to the low UV resistance of the plastic parts of the housing, the gas analyzer must be designed and operated in such a way that the effect of UV radiation can be excluded.

Connecting the gas lines

NOTICE

Damage to the gas analyzer

Damage to the gas analyzer due to condensing sample gas during commissioning.

- Observe the condition of the sample gas inlet of the analyzer modules.
- Purge the sample gas path before commissioning, see **Purge sample gas path and analyzer housing** on page 100.
- Do not connect the sample gas until the gas analyzer has reached room temperature and after the warm-up phase has elapsed, see **Duration of the Warm-up Phase** on page 100.

Connecting the hose lines

Slide the hoses with an inside diameter of 4 mm onto the hose nozzles and fasten with hose clamps.

Connecting the piping

Connect stainless steel pipes professionally to the screwed connection, taking into account the tightness requirements.

Installing the fine filter

A preinstalled fine filter is included in the scope of delivery (see **Scope of delivery** on page 12) of the gas analyzer (one-way filter, order number 769144 – not for Fidas24).

When installing the fine filter, attach the short hose piece to the sample gas inlet; connect the sample gas line to the long hose piece with the hose nozzle.

Installing the flowmeter

Install a flowmeter or flow monitor with needle valve before the sample gas inlet and if necessary before the purge gas inlet to be able to adjust and monitor the gas flow.

Provide for sample gas line purging

Install a shut-off valve in the sample gas line (highly recommended for pressurized sample gas) and provide the option of introducing an inert gas, such as nitrogen, from the gas sampling point, for purging of the sample gas line.

Exhaust gas lines

The exhaust gases of the gas analyzers are dissipated via the sample gas outlets. The exhaust gases can be discharged into the atmosphere via a common exhaust gas line.

Note

Dispose of corrosive, toxic or combustion exhaust gases according to the regulations!

Observe the following points when connecting the exhaust gas lines:

- Guide the exhaust gases from the gas analyzer directly into the atmosphere or in depressurized state through the shortest possible line with a large inside diameter, or into an exhaust pipe.
- Do not install any throttle sections or shut-off valves in the exhaust gas line!
- For Fidas24, also observe the information in **Connecting the exhaust air line** on page 85!

... 4 Installation

Fidas24 – Connect gas lines

Safety instructions

⚠ DANGER

Explosion hazard

Explosion hazard due to leaking combustion gas in the gas analyzer.

- The leak tightness of the combustion gas supply line outside the gas analyzer as well as the combustion gas path in the gas analyzer must be checked regularly.
- The relevant safety regulations for working with combustion gases must be complied with!
- The screwed connections of the gas paths in the gas analyzer may not be opened! The gas paths can become leaky as a result.
 - However, if the screwed connections of the gas paths in the gas analyzer have been opened (only by trained personnel), a leak tightness test must be performed using a hydrogen detector (for example, based on thermal conductivity) must always be carried out after they have been sealed again. The leakage rate must not exceed 10^{-4} hPa·l/s.
- The lines and fittings must be clean and free of any residues (for example, particles left from manufacturing)!
 - Contaminants can enter the analyzer and damage it or lead to false measurement results!

Notes

- The installation of gas connections is described in **Mounting the fittings on the gas analyzer** on page 41.
- Follow the manufacturer's installation instructions for the fittings! In particular, hold the male fittings (gas connections) in place when connecting the gas lines.
- When laying and connecting the gas lines, adhere to the installation instructions provided by the manufacturers of the piping!
- If gas lines made of stainless steel are connected to the analyzer modules, the lines must be connected to the building-side potential equalization.
- Never connect more than three analyzer modules in a series!

Connection of process gases and test gases

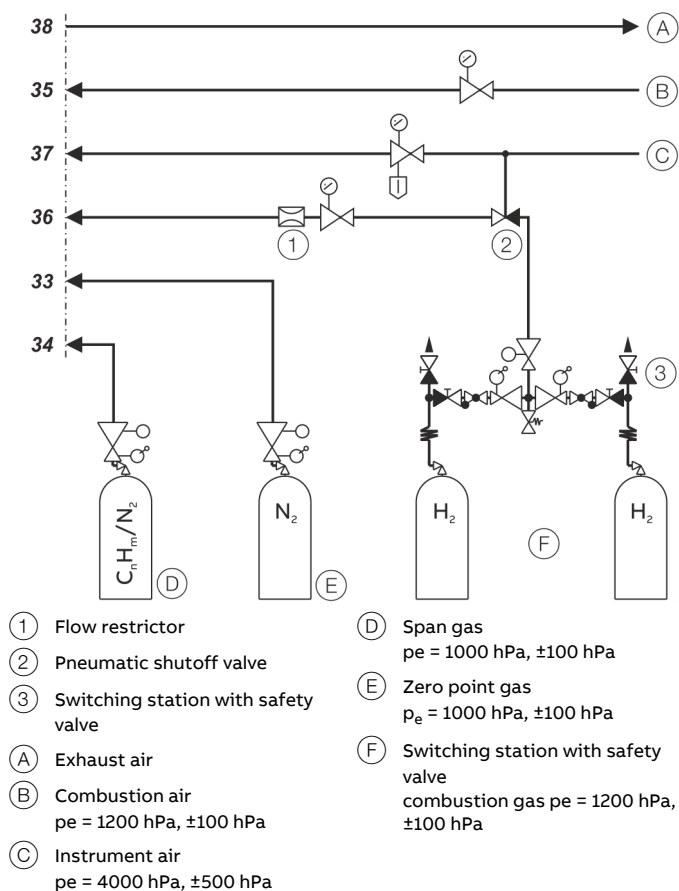

Figure 34: Connection of process gases and test gases

The numbering of the gas connections corresponds to the numbering in Figure 32 and Figure 33 as well as the labeling on the rear of the gas analyzer.

Instrument Air Connection

The instrument air is used as propulsion air for the air jet injector, and as purging air for the housing purging, see **Housing purge** on page 33.

Connect the instrument air line to the instrument air inlet **37** of the gas analyzer via a pressure regulator (0 to 6 bar).

Combustion air connection

Connect the combustion air line to the combustion air inlet **35** of the gas analyzer via a pressure regulator (0 to 1.6 bar).

Combustion gas connection

See section **Combustion gas connection** on page 84.

Test gas connection

The test gas outlet is connected to the sample gas connection at the factory.

If the test gases are to be fed directly at the gas sampling point, the connection between the test gas outlet and the test gas inlet at the sample gas connection should be removed, and the corresponding opening at the sample gas connection is to be sealed gas-tight with an M6 screw.

Connecting the exhaust air line

Observe the following points when connecting the exhaust air pipe:

- Conduct exhaust gases from the gas analyzer directly into the atmosphere or through a de-pressurized pipe with a large inside diameter which is as short as possible, or into an exhaust pipe.
- Use PTFE or stainless steel as the material for the exhaust air line!

The temperature of the exhaust air can be up to 200 °C!

- Install the exhaust air line at a gradient, leading away from the gas analyzer.
- At a maximum of 30 cm after the exhaust air outlet, the exhaust air pipe must have an inside diameter of ≥ 10 mm!

If the exhaust air pipe is very long, its inside diameter must be much larger than 10 mm, otherwise you might have problems with pressure control in the gas analyzer.

- Do not install any throttle sections or shut-off valves in the exhaust air line!

Note

Dispose of corrosive, toxic or combustion exhaust gases according to the regulations!

Fidas24 – Connecting the combustion gas line

Clean combustion gas line.

1. Pump a cleaning agent (alkaline cleaner, stainless steel pickling solution) through the stainless steel pipe.
2. Rinse the pipe thoroughly with distilled water.
3. Purge the pipe with synthetic air or nitrogen, at a > 100 °C, for several hours (10 bis 20 l/h).
4. Seal the ends of the pipe.

Connect combustion gas pipe

See also **Connection of process gases and test gases** on page 84.

1. Connect a two-stage cylinder pressure reducer (a model suitable for high purity gases) to the combustion gas cylinder.
2. Connect the combustion gas pipe to the cylinder pressure reducer.
3. Install a flow restrictor in the combustion gas supply line which limits the combustion gas flow to 10 l/h H₂ or 25 l/h H₂/He mixture, see **Flow restrictor in the combustion gas supply line** on page 31. This means that the operation of the gas analyzer is safe even in the event of a fault in the combustion gas path (such as leakage).
4. Install a shut-off valve in the combustion gas supply line.
 - It is recommended that a pneumatic shut-off valve be installed.
 - The pneumatic shut-off valve must be controlled by the instrument air supply, so that the combustion gas supply is interrupted in the event of a failure of the instrument air supply.
 - See also **Shut-off valve in the combustion gas supply line** on page 31.
5. Connect the combustion gas line to the combustion gas inlet **36** of the analyzer module, via a pressure regulator (0 to 1.6 bar) refer to **Position and design of the gas connections** on page 42.

Check the tightness of the combustion gas line

Check the combustion gas line for tightness, refer to **Combustion gas line** on page 105.

... 4 Installation

Fidas24 – Connecting the sample gas line to the heated sample gas connection

NOTE

Damage to the gas analyzer

Damage to the gas analyzer, due to melting of the factory-mounted plastic plugs in the sample gas inlets.

- Remove the plastic plugs from the sample gas inlets before commissioning.

Material of the sample gas line

Use a PTFE or stainless steel sample gas line! (Recommended: use heated sample gas line TBL 01) The medium temperature can be up to 200 °C!

Sample gas line connection

The heated sample gas line must be connected directly to the sample gas inlet. Make sure that the O-rings are seated correctly and that the sample gas pipe has been inserted into the sample gas connection until it stops.

Unused sample gas inlets

- When the analyzer draws in the sample gas through the sample gas line, the unused sample gas inlets must be sealed using the screw plugs (installed at the factory).
- When the sample gas is under gauge pressure, a sample gas inlet must be open and connected to an exhaust gas line so that there is no gauge pressure in the analyzer.

Screwed connections and O-rings

The required screwed connections and o-rings are included in the supplied accessories bag.

Maximum length of the sample gas line

The maximum length of a heated sample gas line (inner diameter 4 mm) is 60 m.

Provide for Sample Gas Line Purging

Install a shut-off valve in the sample gas line (highly recommended for pressurized sample gas) and provide the option of introducing an inert gas, e.g. nitrogen, from the gas sampling point, for purging of the sample gas line.

Heated sample gas connection

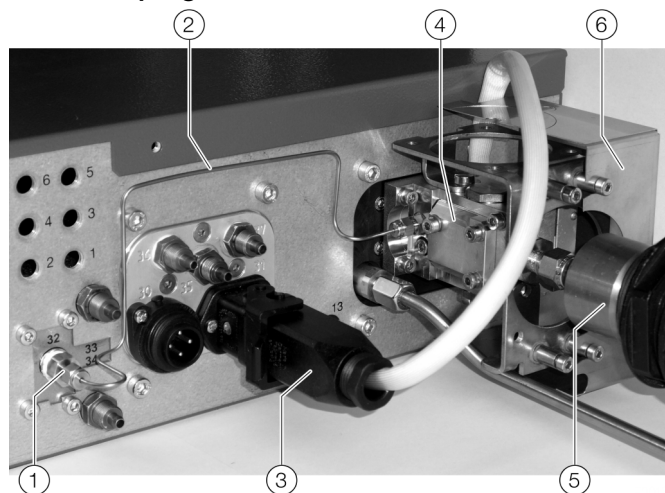

- | | |
|---|------------------------------------|
| ① Test gas outlet | ④ Heated sample gas connection |
| ② Connection of test gas outlet–sample gas connection | ⑤ Heated sample gas line (example) |
| ③ Electrical connection to the heated sample gas connection | ⑥ Sample gas connection cover* |

* Only half of the sample gas connection cover is shown in the figure.

Figure 35: Heated sample gas connection

Connection of the sample gas line to the heated sample gas connection

Wall-mount housing (view from bottom right)

19" housing (view from top left)

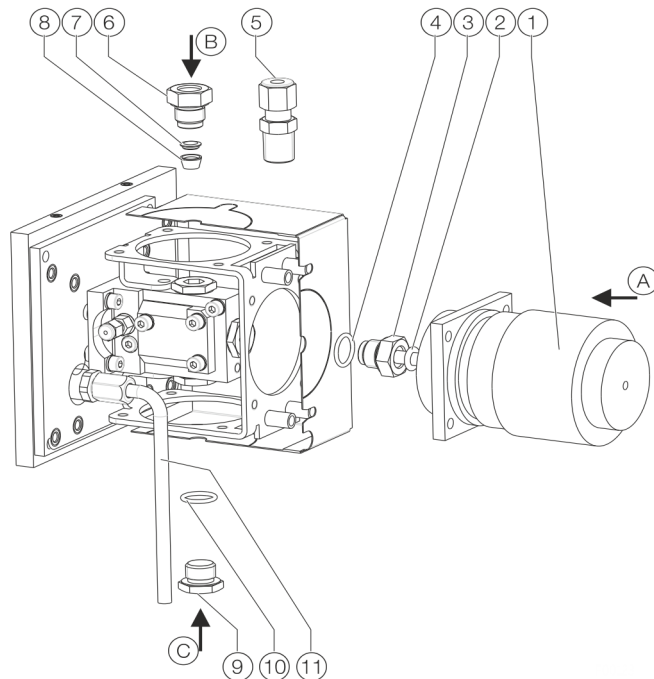
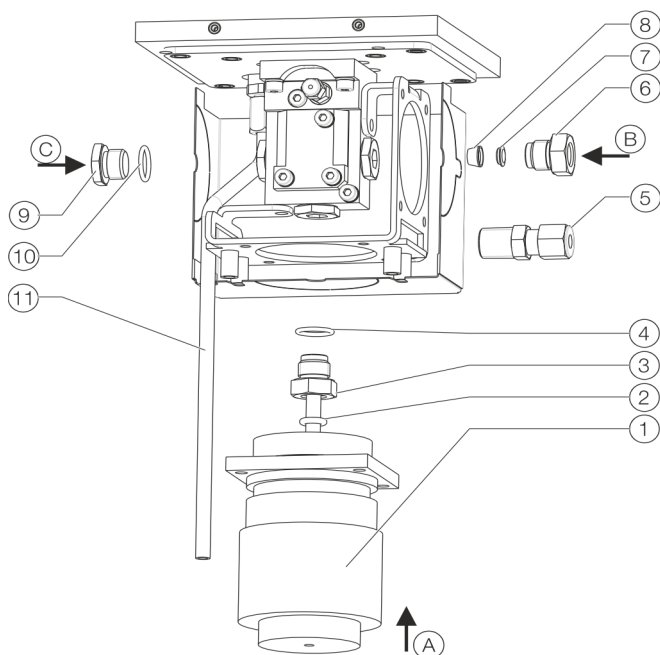

- ① Heated sample gas line (tube with inside/outside diameter 4 / 6 mm)
- ② O-ring 6.02 × 2.62
- ③ Socket
- ④ O-ring 12.42 × 1.78

Closure:

- ⑨ Screw plug
- ⑩ O-ring 12.42 × 1.78
- ⑪ Waste gas tube

Connection of an additional sample gas line (tube with outside diameter 6 mm) either with:

- ⑤ Screw-in connector G¹/₄"

Alternatively, with:

- ⑥ Socket
- ⑦ Wedge ring
- ⑧ Clamping ring

Figure 36: Connecting the sample gas line

Sample gas inlets	Sample gas line connection	
	on 19" housing	on wall-mount housing
(A)	from the rear	from below
(B)	from above	from the right
(C)	from below	Not possible – the sample gas inlet must always be closed

... 4 Installation

Fidas24 – Connecting the sample gas line to the unheated sample gas connection

NOTE

Damage to the gas analyzer

Damage to the gas analyzer, due to melting of the factory-mounted plastic plugs in the sample gas inlets.

- Remove the plastic plugs from the sample gas inlets before commissioning.

Sample gas line connection

The unheated sample gas connection has only one sample gas inlet.

If the sample gas is under positive pressure, a T-piece must be connected between the sample gas line and the sample gas inlet.

The free connection of the T-piece must be connected to an exhaust gas discharge line, so that no positive pressure builds up in the analyzer module.

Maximum length of the sample gas line

The maximum length of the unheated sample gas line (inside diameter 4 mm) is 50 m.

Provide for Sample Gas Line Purging

Install a shut-off valve in the sample gas line (highly recommended for pressurized sample gas) and provide the option of introducing an inert gas, e.g. nitrogen, from the gas sampling point, for purging of the sample gas line.

Connection of the sample gas line to the unheated sample gas connection

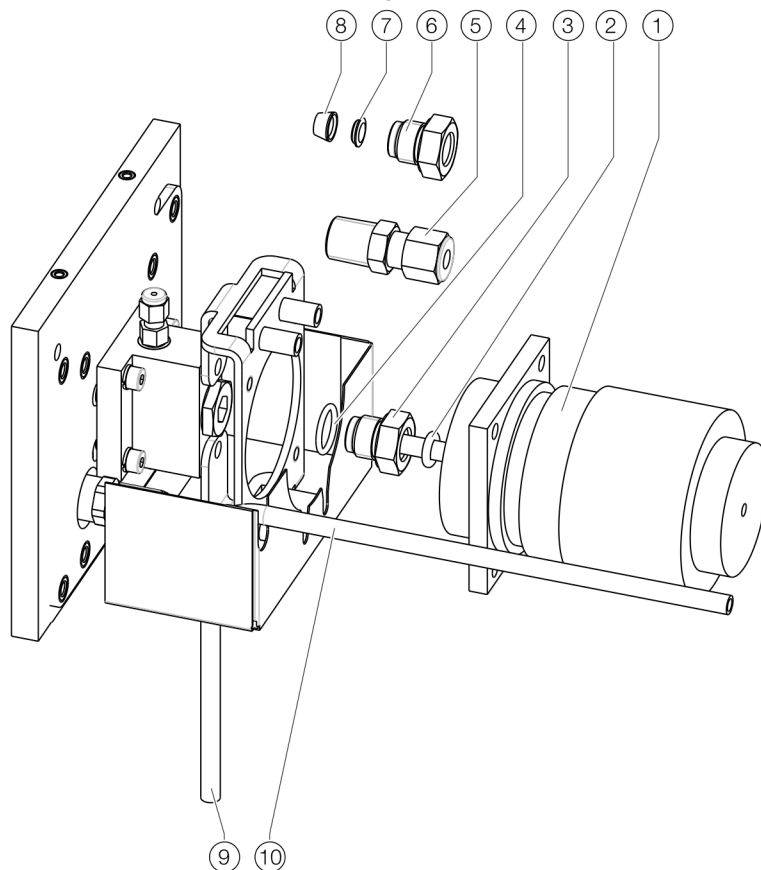

- ① Sample gas line (heated or unheated, PTFE or stainless steel tubing with a 4/6 mm inside/outer diameter)

Connection either with:

- ② O-ring 6.02 × 2.62
 ③ Socket
 ④ O-ring 12.42 × 1.78

Alternatively, with:

- ⑤ Screw-in connector G $\frac{1}{4}$ "

Alternatively, with:

- ⑥ Socket
 ⑦ Wedge ring
 ⑧ Clamping ring
 ⑨ Exhaust gas tube for 19" housing
 ⑩ Exhaust gas tube for wall-mount housing

Figure 37: Connection of the sample gas line to the 19" housing (view from top left)

5 Electrical connections

Safety instructions

⚠ WARNING

Risk of injury due to live parts.

Improper work on the electrical connections can result in electric shock.

- Connect the device only with the power supply switched off.
- Observe the applicable standards and regulations for the electrical connection.

General Notes

Protective lead connection

The protective lead (ground) should be attached to the protective lead connector before any other connection is made.

Risks of a disconnected protective lead

The device can be hazardous if the protective lead is interrupted inside or outside the device or if the protective lead is disconnected.

Model EL3020

Safety instructions

Observe the relevant national safety regulations for installing and operating electric systems.

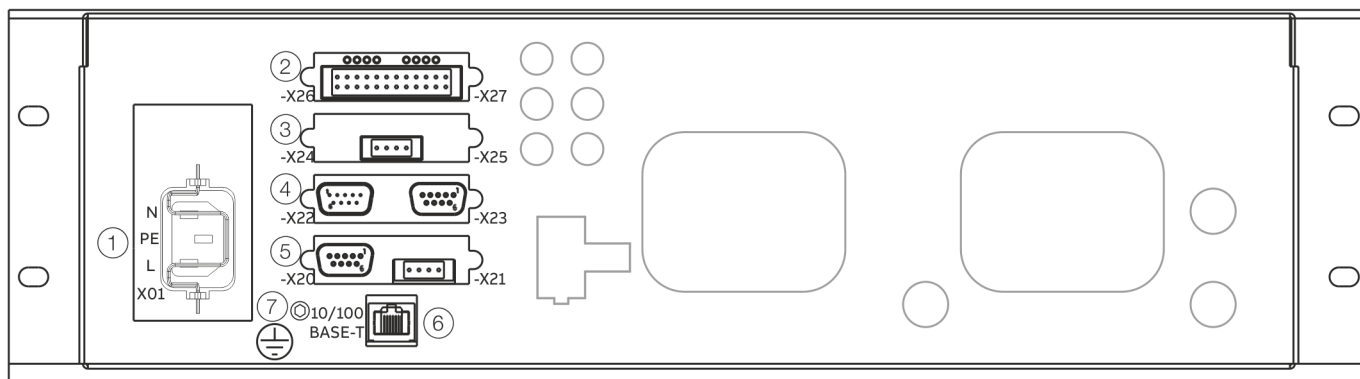

- | | |
|---|---|
| ① Power supply connection
(see Connecting the power supply on page 97)
(3-pin grounded instrument connector in accordance with EN 60320-1/C14; connection cable included in scope of supply) | ④ Modbus module
(see Modbus®-Module on page 96) |
| ② Digital I/O module
(see Digital I/O module on page 94) | ⑤ Profibus module
(siehe PROFIBUS®-Module on page 96) |
| ③ Analog output module
(see Analog output modules on page 93) | ⑥ Ethernet 10/100BASE-T interface (for configuration and software update as well as for transferring the QAL3 data) |
| | ⑦ Potential equalization connection (terminal capacity max. 4 mm ²) |

Figure 38: Electrical connections model EL3020

Note

The figure shows all available I/O module types and shows only an example of the assembly with I/O modules (max. 4). The actual assembly of a delivered gas analyzer may differ from this; it is documented in the device data sheet.

Model EL3040

Safety instructions

Observe the relevant national safety regulations for installing and operating electric systems.

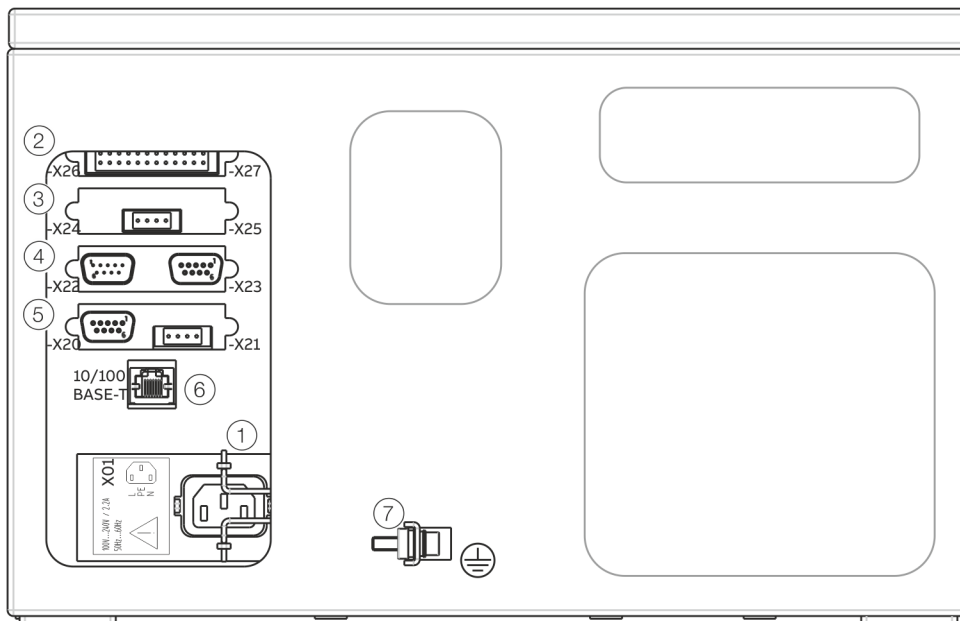

- | | |
|---|---|
| <p>① Power supply connection
(see Connecting the power supply on page 97)
(3-pin grounded instrument connector in accordance with EN 60320-1/C14; connection cable included in scope of supply)</p> <p>② Digital I/O module
(see Digital I/O module on page 94)</p> <p>③ Analog output module
(see Analog output modules on page 93)</p> | <p>④ Modbus module
(see Modbus®-Module on page 96)</p> <p>⑤ Profibus module
(see PROFIBUS®-Module on page 96)</p> <p>⑥ Ethernet 10/100BASE-T interface (for configuration and software update as well as for transferring the QAL3 data)</p> <p>⑦ Potential equalization connection (terminal capacity max. 4 mm²)</p> |
|---|---|

Figure 39: Electrical connections model EL3040

Note

The figure shows all available I/O module types and shows only an example of the assembly with I/O modules (max. 4). The actual assembly of a delivered gas analyzer may differ from this; it is documented in the device data sheet.

... 5 Electrical connections

... Model EL3040

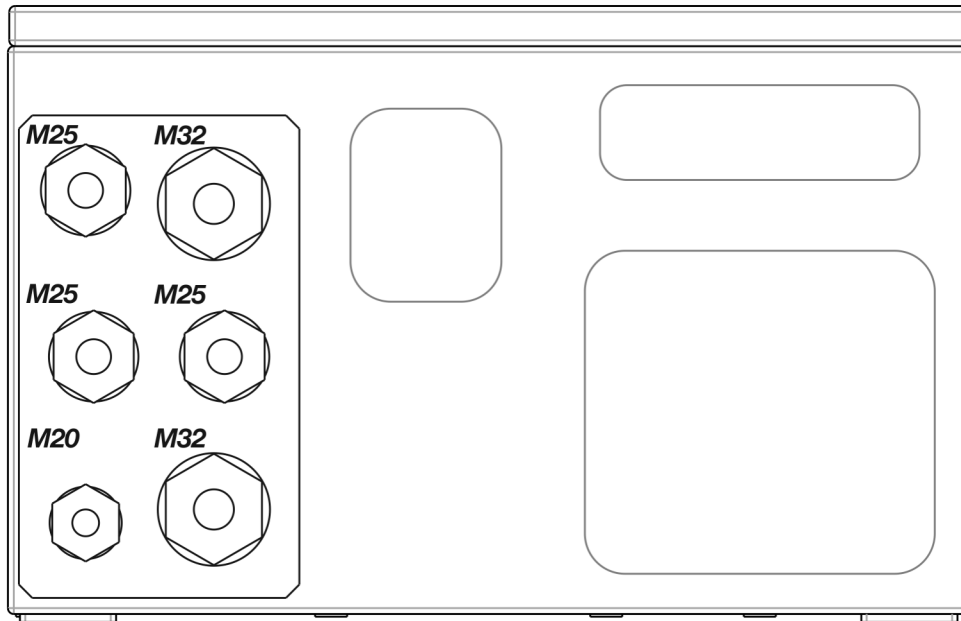

Figure 40: Cable glands model EL3040

Type	Application (recommended)	Permissible cable diameter
M20	Power supply	5 to 13 mm
M25	Modbus / Profibus	8 to 17 mm (insert 5 × 4 mm)
M25	Network	8 to 17 mm
M25	3 × analog outputs	8 to 17 mm (insert 3 × 7 mm)
M32	Digital inputs/outputs	12 to 21 mm
M32	Digital inputs/outputs	12 to 21 mm

Analog output modules

Terminal layout

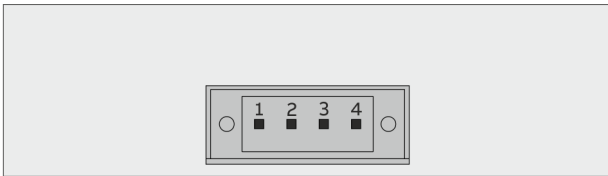

Image 41: 2-way analog output module

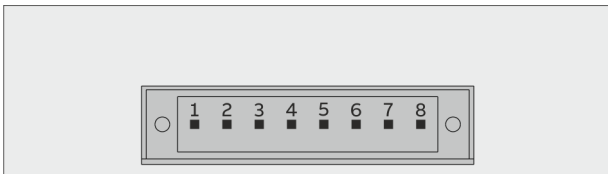

Image 42: 4-way analog output module

Pin	Signal
1	AO1+
2	AO1-
3	AO2+
4	AO2-
5	AO3+
6	AO3-
7	AO4+
8	AO4-

Analog outputs AO1 to AO4

0/4 to 20 mA (factory-set to 4 to 20 mA), common negative pole, electrically isolated from ground, freely connectible to ground, max. gain relative to protective ground potential 50 V, max. load 750 Ohm. Resolution 16 bit.

The output signal cannot be lower than 0 mA.

Version

4-pole or 8-pole plug-in terminal strip with counter plug (included in the scope of delivery).

Terminal assignment

An analog output is allocated in the sequence of the sample components for each sample component.

The sequence of the sample components is documented in the analyzer data sheet and on the name plate.

Note

The allocation of the terminals can be changed in the configurator.

Refer to Operating instruction.

... 5 Electrical connections

Digital I/O module

Terminal layout

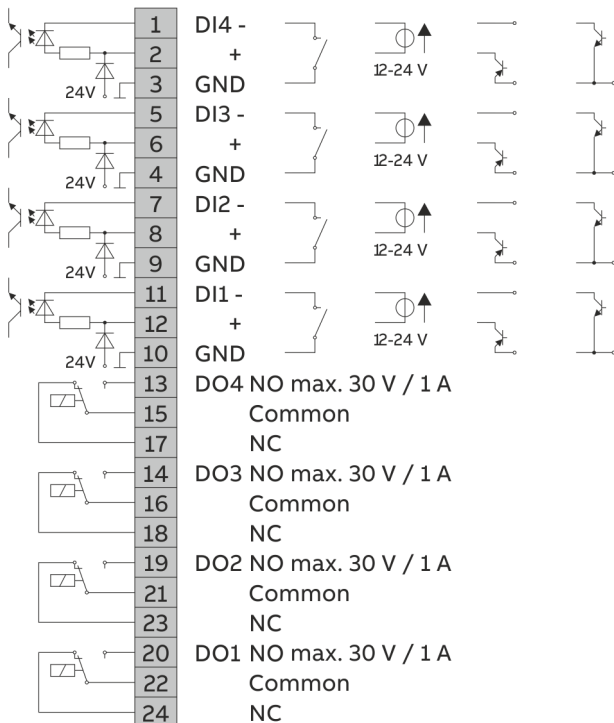
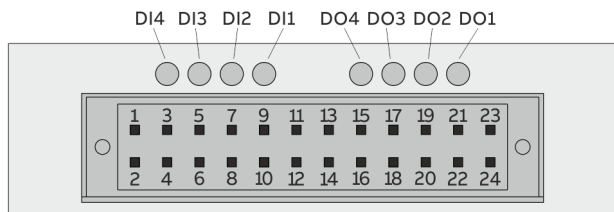

Digital inputs DI1 to DI4

Optocouplers with internal 24 V DC power supply. Control system alternatively available with potential-free contacts, with external voltage 12 to 24 V DC or with PNP or NPN open-collector driver.

Digital outputs DO1 to DO4

Potential-free changeover contacts, maximum contact load capacity 30 V/1 A.

Relays must at all times be operated within the specified data range.

Inductive or capacitive loads are to be connected with suitable protective measures (self-induction recuperation diodes for inductive loads and series resistors for capacitive loads).

Relays are shown in the unpowered state.

The unpowered state corresponds to the state in the event of a fault ("fail safe").

Version

2 × 12-pole plug-in terminal strip with mating connector (included in the scope of delivery).

Image 43: Electrical connections, digital I/O module

Standard assignment of digital inputs and digital outputs

Function	Digital I/O Module 1	Digital I/O Module 2
Failure		
Maintenance required		
Maintenance mode		
Overall status	DO1	
Start automatic calibration	DI1	
Stop automatic calibration		
Disable automatic calibration	DI2	
Sample gas valve	DO4	
Zero point gas valve		
Span gas valve 1		
Span gas valve 2		
Span gas valve 3		
Span gas valve 4		
Span gas valve 5		
Pump, on/off*		
Limit 1	DO2	
Limit 2	DO3	
Limit 3		DO1
Limit 4		DO2
Limit 5		DO3
Limit 6		DO4
Limit 7		
Limit 8		
Limit 9		
Limit 10		
Measuring range switch-over		
Measuring range feedback		
Measuring component switch-over		
Measuring component feedback		
Bus-DI 1		
Bus-DI 2		
Bus-DI 3		
Bus-DI 4		
Bus-DI 5		
Bus-DI 6		
Bus-DI 7		
Bus-DI 8		
External failure**	DI3	
External maintenance request**	DI4	

* If a pump is installed ('Integral gas feed' option – only in model EL3020, not for Limas23, ZO23, Fidas24).

** Multiple external status signals can be configured depending on the number of free digital inputs.

Note

The allocation of the terminals (see Operating instruction) can be changed in the configurator.

... 5 Electrical connections

Modbus®-Module

Terminal layout

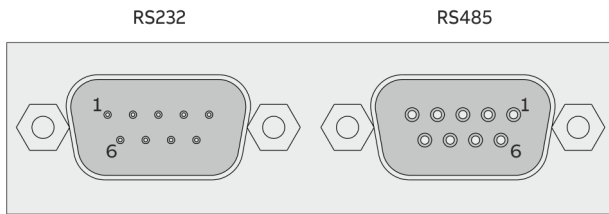

Figure 44: Modbus module

RS232 Interface

Version: 9-pin sub-D male connector

Pin	Signal
2	RxD
3	TxD
5	GND

RS485 interface

Version: 9-pin sub-D female connector

Pin	Signal
2	RTxD-
3	RTxD+
5	GND

Note

You will find detailed information regarding the “Modbus” in the description of the interface “COM/EL3000/MODBUS”.

Note

The Modbus® protocol is an unsecured protocol, as such the intended application should be assessed to ensure that these protocols are suitable before implementation.

PROFIBUS®-Module

Terminal layout

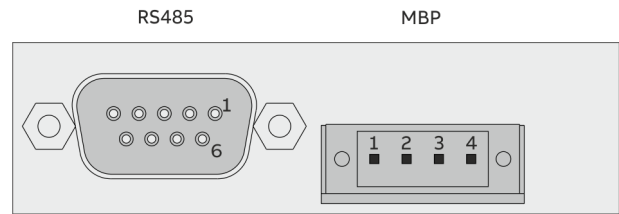

Image 45: PROFIBUS® module

RS485 interface

Version: 9-pin sub-D female connector

Pin	Signal	Description
1	—	not assigned
2	M24	24 V output voltage, ground
3	RxD/TxD-P	Receive/transmit data plus, B-line
4	—	not assigned
5	DGND	Data transmission potential (Reference potential for VP)
6	VP	Supply voltage plus (5 V)
7	P24	24 V output voltage plus, max. 0.2 A
8	RxD/TxD-N	Receive/transmit data N, A-line
9	—	not assigned

MBP Interface (not intrinsically safe)

Model: 4-pole plug-in terminal strip with mating connector (included in the scope of delivery).

Pin	Signal
1	+
2	Shield
3	-
4	not used

Note

You will find detailed information regarding PROFIBUS® in the ‘30/24-415’ technical information.

Note

The PROFIBUS® protocol is an unsecured protocol (in the context of IT or cyber security), therefore the intended application should be assessed before implementation, in order to ensure that the protocol is suitable.

Connecting the Signal Lines

Safety instructions

- Follow local regulations on installing and connecting electrical wiring.
- Lay the signal lines separately from the power supply lines.
- Lay analog and digital signal lines separately from each other.
- Label cables or counter plug so that they can be clearly allocated to the corresponding I/O modules.

Requisite Material

Refer to **Signal Lines** on page 13.

Connecting the Signal Lines

1. Only for the wall-mounted housing (model EL3040):
Feed the cables through the cable glands and strip them over a length of approx. 18 cm, see **Model EL3040** on page 91.
 - M20 and M32 cable gland:
Remove the plug from the insert; leave the ring in the gland to act as a gasket and to provide strain relief.
 - Cable gland M25:
Remove the plug from the gland. Remove the drilled insert from the accessory bag and if necessary, slit it open and press it over the cable; close any free drill holes with dowel pins from the accessory bag.
2. Connect the cables to the opposite connectors, according to the connection diagrams of the I/O modules.
 - Analog output module, see **Analog output modules** on page 93
 - Digital-I/O module, see **Digital I/O module** on page 94
3. Connect the opposite connectors to the plug-in terminal strips on the I/O modules.

Connecting the power supply

NOTICE

Damage to the gas analyzer

Damage to the gas analyzer due to condensing sample gas during commissioning.

- Observe the condition of the sample gas inlet of the analyzer modules.
- Purge the sample gas path before commissioning, see **Purge sample gas path and analyzer housing** on page 100.
- Do not connect the sample gas until the gas analyzer has reached room temperature and after the warm-up phase has elapsed, see **Duration of the Warm-up Phase** on page 100.

NOTICE

Heater damage

Damage to the detector heater and the heated sample gas connection due to an improper connection.

- Attach or disconnect the connector **30** of the power supply for heating the detector and the heated sample gas connection only if the gas analyzer is de-energized.

Requisite Material

If the supplied mains lead is not used, select conductive material which is appropriate for the length of the lines and the predictable current load.

Potential equalization

The gas analyzer has a terminal marked with the symbol \oplus for connection with the building-side potential equalization. The connector has a clamping range of max. 4 mm².

Grid connection cable EL3000

For the power supply of the gas analyzer, a connection cable (length 5 m, conductor cross section 3 × 1.5 mm²) with a 3-pole cold device plug is included in the scope of supply.

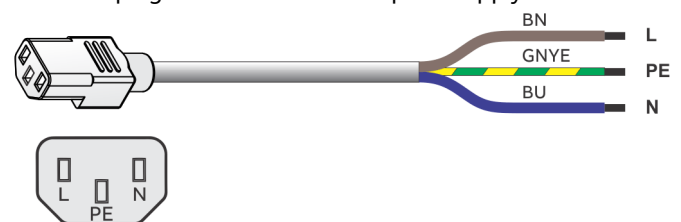

Figure 46: Pin side of the plug 30

... 5 Electrical connections

... Connecting the power supply

Grid connection cable Fidas24

A connection cable is provided for the power supply (115 / 230 V AC) for heating the detector and, if necessary, the heated sample gas connection (length 5 m, cable cross-section $3 \times 1.5 \text{ mm}^2$) with a 4-pole socket connector for the connection to the analyzer module.

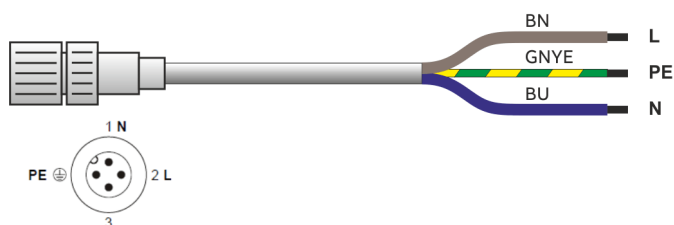

Figure 47: Pin side of the plug 30

The illustration shows the pin side of the plug **30** on the analyzer (see **Figure 32** on page 80).

The operating voltage of the detector heating is automatically detected and switched. The set voltage can be identified through two LEDs on the mains distribution card.

Connect power supply lines

1. Ensure that the power supply feeder has an adequately dimensioned protective device (circuit-breaker).
2. Install an easily accessible mains isolator or a switched socket in the power supply line, close to the gas analyzer, so that all the poles of the gas analyzer can be disconnected from the power supply if necessary. Label the supply circuit isolator to make it clear that it is associated with the device that needs to be isolated.
3. Plug the cold device power cable into the power supply connection **X01** (see **Figure 38** on page 90 and **Figure 39** on page 91) of the gas analyzer and fasten the plug with the bracket.
4. Attach the Fidas24 power cable to the power supply connection **30** (see **Figure 32** on page 80 and **Figure 33** on page 81) of the Fidas24 analyzer module and tighten.
5. Connect the other ends of the power cable to the power supply.
6. If stipulated by the relevant installation regulations, connect the gas analyzer to the building's equipotential grounding system.

Note

The supply circuit isolator must mutually isolate the power supply of the gas analyzer and the Fidas24.

Note

The gas analyzer can be put into operation as soon as it is connected to the power supply of the building.

6 Commissioning

Safety instructions

NOTICE

Damage to the gas analyzer

Damage to the gas analyzer due to condensing sample gas during commissioning.

- Observe the condition of the sample gas inlet of the analyzer modules.
- Purge the sample gas path before commissioning, see **Purge sample gas path and analyzer housing** on page 100.
- Do not connect the sample gas until the gas analyzer has reached room temperature and after the warm-up phase has elapsed, see **Duration of the Warm-up Phase** on page 100.

When safe operation can no longer be assured

If it is apparent that safe operation is no longer possible, the device should be taken out of operation and secured against unauthorized use.

The possibility of safe operation is excluded:

- If the device is visibly damaged,
- If the device no longer operates,
- After prolonged storage under adverse conditions,
- After severe transport stresses.

Installation Check

1. Is the gas analyzer securely fastened, see **Gas Analyzer Installation** on page 82?
2. Are all gas lines including that of the pressure sensor correctly connected and installed, see **Installing the fittings** on page 41?
3. Are all signal lines and power supply lines correctly connected and installed, see **Connecting the Signal Lines** on page 97 and **Connecting the power supply** on page 97?
4. Are all devices and equipment needed for gas conditioning, calibration and exhaust gas disposal correctly connected and ready for use?
5. When measuring flammable gases: are the special conditions complied with, see **Special conditions for the measurement of combustion gases** on page 38?
6. When using the explosion-proof design in degree of protection II 3G: are the special conditions complied with, see **Special conditions for the model EL3040 gas analyzer in degree of protection II 3G** on page 15?

... 6 Commissioning

Purge sample gas path and analyzer housing

Before the gas analyzer is commissioned and the sample gas is connected, the sample gas path and, if necessary, the wall housing must be purged.

First of all, this makes sure that before commissioning, the sample gas paths and wall-mounted housing are free from contaminants, e.g. corrosive gases and accumulations of dust.

Secondly, this prevents any explosive gas / air mixture present in the sample gas paths or wall-mounted housing from being ignited when the power supply is powered-up.

Initial purging upon commissioning

Pre-purging the gas path

Purge gas	Nitrogen
Purge gas flow	Maximum 100 l/h
Purge time	approx. 20 s

Housing purge*

Purge gas	Nitrogen
Purge gas flow	Maximum 200 l/h
Purge time	Approx. 1 hour

* Not for Fidas24, see for a separate description at **Housing purge with Fidas24** on page 34.

If the purge gas flow is lower than specified, the duration of the purging must be extended accordingly.

Housing purge with Fidas24

In the Fidas24 gas analyzer, the housing purge is provided in such a way that a part (approx. 600 to 700 l/h) of the instrument air is conducted continuously through the housing as purge air.

Thus it is guaranteed that no ignitable gas mixture can form within the housing in case of a leak in the combustion gas path. The housing purge is always active when pressurized air is on, that is also when the instrument air valve is closed.

Gas analyzer start-up

Note

For the analyzers ZO23 and Fidas24, the instructions specified in **ZO23 – Commissioning the gas analyzer** on page 101 or **Fidas24 – Commissioning the gas analyzer** on page 101 must be observed.

General description of commissioning

1. Turn on the gas analyzer power supply.
2. During the start-up phase ('Booting'), the LCD display shows the name of the gas analyzer and the number of the software version.
3. At the end of the start-up phase, the LCD display switches over to display the measured values.

Example:

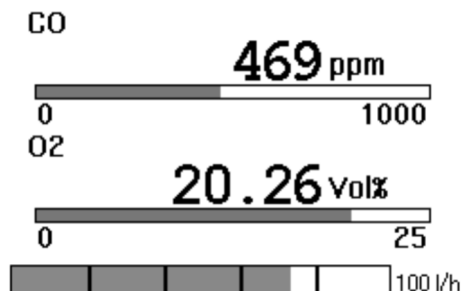

4. Check the gas analyzer configuration and change if necessary, see Operating instruction.
5. Once the warm-up phase is complete, the gas analyzer is ready to begin the measurement process, see **Duration of the Warm-up Phase** on page 100.
6. Check the gas analyzer calibration, see Operating instruction. The gas analyzer is factory calibrated. However, transport influences as well as the pressure and temperature conditions at the installation site can influence the calibration.
7. Turn on the sample gas supply.

Duration of the Warm-up Phase

Analyzer	Duration of the Warm-up Phase
Uras26	Without thermostat: approx. ½ h With thermostat: approx. 2 h
Limas23	Approx. 2 hours
Magnos206	< 1 hours
Magnos28	< 5 h, The value may be elevated during first commissioning or after a longer service life.
Magnos27	2 to 4 h
Caldos27	Approx. ½ h
Fidas24	Approx. 2 hours
ZO23	approx. 2 h, see for detailed information ZO23 – Commissioning the gas analyzer on page 101.

Z023 – Commissioning the gas analyzer

Note

We recommend starting the first calibration procedure at the installation site on the day before the actual measurement operation is started, so that the gas paths and valves can be purged as long as possible.

Commissioning the gas analyzer, first calibration at the installation site:

1. Power-up the power supply on the gas analyzer.
 - After 15 min, the operating temperature of the cell has been reached, the corresponding status message goes out. From this moment on, the gas can be connected.
2. Supply ambient air for setting the reference point (= electric zero point) and wait for the measured value to stabilize (time approx. 2 h).
 - During this time, flush the test gas valves and the gas inlet line with oxygen-free gas (for example, with nitrogen from a ring line) or with sample gas (flow rate 5 to 10 l/h).
3. Set the reference point to the oxygen content of the ambient air, taking into account the air humidity. See calculation example in **Test gases** on page 25.
4. Use nitrogen to flush the entire gas path and the valves, which was previously blown with air. It's best to do this for at least 12 hours, for example overnight.
5. Feed in the span gas and wait for the measured value to stabilize (max. duration 2 h).
6. Set the end point value in accordance with the analysis certificate of the test gas cylinder used.
7. The gas analyzer is ready for measurement; connect sample gas.

Note

For information on the test gases, refer to **Z023** on page 25.

Fidas24 – Commissioning the gas analyzer

Power-up the power supply, heat-up phase, connect operating gases

1. Switch on the power supply of the gas analyzer and the heaters of the Fidas24.
2. During the start-up phase 'Booting', the LCD display shows the name of the gas analyzer and the number of the software version. At the end of the start-up phase, the LCD display switches over to display the measured values.
3. Select the 'Controller Values' menu item:
'▼ Maintenance / ▼ Diagnosis / ▼ Device Status / ► Analyzer Status / ▲ Controller Values'
Under this menu item, both the actual and setpoint values and the manipulated variables of the internal temperature controllers are displayed:

T-Re.D:	Detector temperature
T-Re.E:	Temperature of the heated sample gas connection
T-Re.K:	Internal combustion air conditioning temperature
TR.VV1:	Temperature of the pre-amplifier

The temperature values increase slowly after activating the power supply.

4. Switch on the instrument air, combustion air and combustion gas (H₂ or H₂/He mixture). Adjust the pressure to the value specified in the Device Data Sheet with the corresponding external pressure regulator.
5. The 'Controller Values' menu item also displays both the actual and set point values and the manipulated variables of the internal pressure controllers:

C Air:	Combustion air pressure
C Gas:	Combustion gas pressure (H ₂ or H ₂ /He mixture)
MGE:	Pressure at the sample gas nozzle
MGA:	Pressure in the combustion chamber (output)

Note

The following status messages are active during the heating-up phase:

... 6 Commissioning

... Gas analyzer start-up

6. During the heating phase, the following status messages are displayed:

Message	Description
Working temperature	the temperature of the detector has not yet reached the threshold.
Flame error	the flame has not yet ignited.
Temperature limit value 1, 2	The temperature of the detector (T-Re.D) and if applicable the heated sample gas connection (T-Re.E) up-scales or down-scales the upper or lower limit value 1 or 2.
Pressure limit value 1, 2	The pressure at one of the internal pressure regulators for instrument air (inlet, outlet), combustion air (air) or combustion gas (H₂) up-scales or down-scales the upper or lower limit value 1 or 2.

7. As soon as the temperature of the detector reaches the threshold value (150 °C), the corresponding solenoid valve in the analyzer automatically switches off the instrument air. The negative pressure regulation and the combustion air regulation attempt to adjust the pressures to the respective set point. The sample gas begins to flow through the analyzer after the instrument air is connected.
8. After the pressures have been adjusted to the respective set point, the respective solenoid valve in the analyzer automatically connects the combustion gas. The combustion gas regulation attempts to adjust the pressure to the set point.

Adjust output variables of the internal pressure controllers
If the analyzer cannot be commissioned automatically with the pressure values specified in the device data sheet, the manipulated variables of the internal pressure controllers must be adjusted.

Note

In order to bring the pressure regulators into a more favorable control range, the external supply pressures can be adapted with the aid of the manipulated variables. However, this should only be done once the flame has been ignited.

In general, this is not necessary.

9. Instrument air:
Use the external pressure regulator to set the controlled variable for Outlet to approx. 60 % (max. 70 %).
Manipulated variable too high → Reduce pressure.
Manipulated variable too low → Increase pressure.
(The controlled variable for "Inlet" depends on the sample gas flow rate.)
10. Combustion air:
Use the external pressure regulator to set the control variable for "air" to approx. 55 % (max. 60 %).
Manipulated variable too high → increase pressure.
Controlled variable too low → reduce pressure.
11. Combustion air:
Use the external pressure regulator to set the manipulated variable for 'H₂' to approx. 42 % (max. 52 %).
Manipulated variable too high → increase pressure.
Controlled variable too low → reduce pressure.

Igniting the flame

12. Flame ignition is automatic.

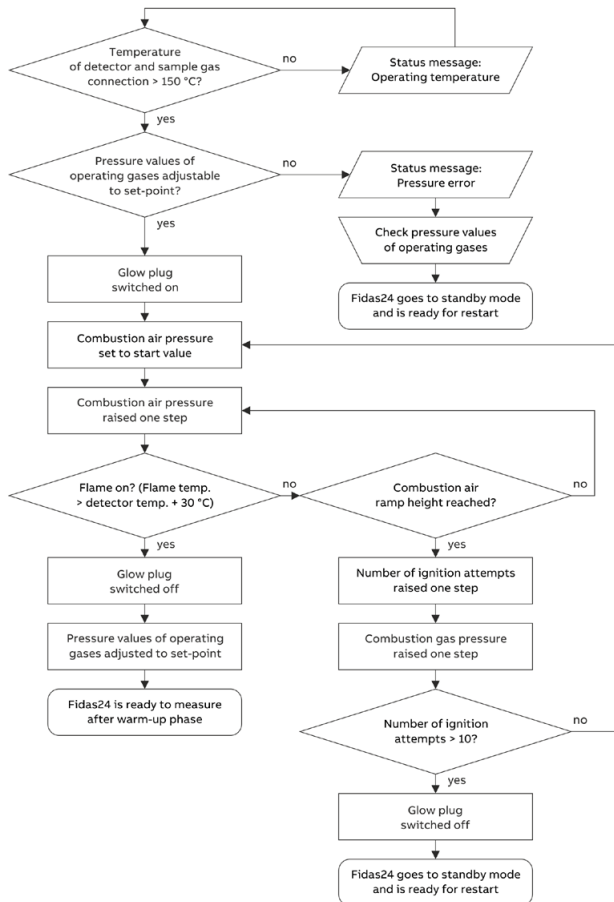

Image 48: Igniting the flame

Depending on the number of ignition attempts, flame ignition can take up to 10 minutes.

On initial commissioning of the gas analyzers, it may occur that, depending on the position of the combustion gas line, there is not sufficient combustion gas available to ignite the flame at first. In this case, you need to go to the 'Fidas Restart' menu to restart the ignition of the flame, see **Fidas24 – Standby / Restart** on page 104.

The flame temperature is also displayed in this menu. The flame is considered to be 'on' when the flame temperature is at least 30 °C higher than the detector temperature.

With the ignition of the flame, the actual commissioning of the gas analyzers is ended.

Note

Unused sample gas lines and sampling probes may continue to emit hydrocarbons for an extended period after initial operation. As a result, it can take much longer for the measured value drift to reach an acceptable value.

Recommissioning the gas analyzer

⚠ CAUTION

Risk of burns

Risk of burns on the hot (> 70 °C) cover of the heated sample gas connection.

- Do not touch the cover of the heated sample gas connection.

NOTICE

Heater damage

Damage to the detector heater and the heated sample gas connection due to an improper connection.

- Attach or disconnect the connector **30** of the power supply for heating the detector and the heated sample gas connection only if the gas analyzer is de-energized.

- Feed in instrument air and combustion air and purge the gas analyzer for **at least 20 minutes**
- Check the leak tightness of the combustion gas supply line, see **Check the integrity of combustion gas path** on page 105.
- Turn on the gas analyzer power supply.
- Power-up the combustion gas supply and check the combustion gas pressure.
- Turn on the sample gas supply.

... 6 Commissioning

Fidas24 – Standby / Restart

Definitions

- **Standby mode:**
Heater on, combustion gas valve closed, combustion air valve closed, instrument air valve closed, housing purging on, zero gas valve opened in standby mode with purging of the detector.
- **Fail-safe mode:**
Fail-safe means: heater off, combustion gas valve closed, instrument air valve closed, housing purging on, zero gas valve open.

Set Fidas24 in Standby mode

- ▲ Operation / ► Pump / Standby / ▼ Fidas Standby
► Fidas Standby'

In the 'Fidas Standby' menu, you can choose between the 'Standby & Purge' and 'Standby' operating modes:

Standby	Standby mode is activated.
Standby & Purge	Standby mode with opening of the zero gas valve for purging the detector is activated (only when executing with test gas connection).

In standby mode, there is a 'Function check' status signal (see "**Diagnosis / error messages**" in the operating instruction) and the status message no. 411 'Fidas24 Standby mode' (see "**Diagnosis / error messages**" in the operating instruction) is issued; the measured values are invalid.

Note

If the Fidas24 is in fail-safe mode (see "**Diagnosis / error messages**" in the operating instruction), it cannot be set to standby mode.

Setting Fidas24 back to measurement mode

- ▲ Operation / ► Pump / Standby / ▼ Fidas Standby
▼ Fidas Restart'

The menu 'Fidas Restart' shows the most important operating parameters of the Fidas24:

F-D1	Flame temperature
B-Air	Combustion air pressure
B-Gas	Combustion gas pressure

The restart is initiated by pressing **OK**. After initiating the restart, you can leave the menu by selecting ◀; the restart sequence will continue to be executed. The restart sequence can, however, also be observed further in the menu.

Note

If the Fidas24 is in fail-safe mode (see "**Diagnosis / error messages**" in the operating instruction), it cannot be set to measurement mode.

Checking gas path leak tightness

When should gas paths be checked for leak tightness?

The leak tightness of the sample gas path should be checked on a regular basis.

We recommend that you check the leak tightness of the sample gas path prior to commissioning at the installation site, as it may have been affected during transport of the gas analyzer (for example, due to high vibrations).

The leak tightness of the sample gas path must always be checked after the sample gas path has been opened inside the gas analyzer.

Requisite Material

- Pressure gauge
- Hose, length approx. 1 m
- T-piece with stop cock
- Air or nitrogen

DANGER

Explosion hazard

Explosion hazard due to mixing of air and flammable sample gas residues in the sample gas path.

- If the leak tightness test is to be carried out with air and the sample gas or test gas is flammable, the sample gas path must be rinsed with nitrogen beforehand!
- Otherwise the leak tightness test can be performed with nitrogen.

Check leak tightness

1. Close off the sample gas output so it is gas-tight.
2. Connect the T-piece with stop cock to the sample gas inlet with the hose.
3. Connect the free end of the T-piece to the pressure gauge.
4. Blow air or nitrogen through the stop cock until the sample gas feed path is under a gauge pressure of approx. 50 hPa. Maximum gauge pressure = 150 hPa.
5. Close the shut-off valve. The pressure should not change measurably in 3 minutes. A sharp pressure drop is an indication of a leak inside the sample gas path.
6. Repeat steps 1 to 5 for all sample gas paths in the gas analyzer.

Check the integrity of combustion gas path

Combustion gas line

The seal integrity of the combustion gas feed line must be regularly checked in accordance with the two following instructions, depending on whether the combustion gas is offered from a bottle or a central supply.

Combustion gas supply from a cylinder

1. Switch off the gas analyzer power supply. Ensure that the shut-off valve in the combustion gas supply line is open.
2. Set the combustion gas pressure at 1.1 x the normal pressure of the combustion gas, i.e. at approx. 1.4 bar.
3. Mark bottle pressure display on the high-pressure manometer.
4. Close the valve of the combustion gas bottle.
5. Observe the display on the high-pressure manometer – it should not change measurably in 10 minutes.
 - A measurable change in the display is an indication of a leak in the combustion gas path between the bottle pressure reducer and the combustion gas inlet valve of the gas analyzer.

In this case the following measures are to be taken:

- Check the combustion gas line between the bottle and gas analyzer with a leak detection spray. A leak in this area must be remedied and another leak test must be performed before the gas analyzer is put into operation again.
- If no leak is found, that means the gas analyzer combustion gas inlet valve is leaky.

DANGER

Explosion hazard

Explosion hazard if there is a leak in the combustion gas inlet valve.

If a leak is detected at the combustion gas inlet valve:

- Disconnect the combustion gas supply.
 - Do not restart the gas analyzer.
 - Have the combustion gas valve replaced by the ABB Service team.
6. After conclusion of the seal integrity test, set the combustion gas pressure to normal pressure again, i.e. 1.2 bar.

... 6 Commissioning

... Check the integrity of combustion gas path

Combustion gas supply from a central unit

1. Switch off the gas analyzer power supply. Ensure that the shut-off valve in the combustion gas supply line is open.
2. Set the combustion gas pressure at 1.1 x the normal pressure of the combustion gas, i.e. at approx. 1.4 bar.
3. Mark pressure indication on the manometer of the pressure reducer.
4. Shut off the combustion gas supply.
5. Observe the display on the manometer – it should not change measurably in 10 minutes.
 - A measurable change in the display is an indication of a leak in the combustion gas path between the pressure reducer and the combustion gas inlet valve of the gas analyzer.
In this case the following measures are to be taken:
 - Check the combustion gas line between the pressure reducer and gas analyzer with a leak detection spray. A leak in this area must be remedied and another leak test must be performed before the gas analyzer is put into operation again.
 - If no leak is found, that means the gas analyzer combustion gas inlet valve is leaky.

DANGER

Explosion hazard

Explosion hazard if there is a leak in the combustion gas inlet valve.

If a leak is detected at the combustion gas inlet valve:

- Disconnect the combustion gas supply.
- Do not restart the gas analyzer.
- Have the combustion gas valve replaced by the ABB Service team.

Combustion gas path in the gas analyzer

1. The gas analyzer must be in operation (flame on).
2. Inspection of combustion gas feed path with positive pressure (combustion gas inlet to combustion gas nozzle):
 - Check all connection points with a hydrogen detector (for example, based on thermal conductivity) for leakage of combustion gas.
 - The leakage rate may not up-scale 10^{-4} hPa l/s.
3. Inspection of the combustion gas feed path with negative pressure (in the detector, after the combustion gas nozzle):
 - Connect zero gas at the sample gas inlet.
 - Shroud all joints successively with a small cloud of a gas that contains hydrocarbons (e.g. with a cold spray or a test gas that contains hydrocarbons, or a cloth soaked in acetone).
 - Observe the measured value display; if the measured value changes to a positive value, the relevant connection is **leaking**.

6. After conclusion of the seal integrity test, set the combustion gas pressure to normal pressure again, i.e. 1.2 bar.

Important instructions for measuring combustion gases

Measures to take after each opening of the gas paths within the gas analyzer

- If the sample gas path inside the gas analyzer has been opened, leak tightness should be checked afterwards with a helium leakage test for a leakage rate of $< 1 \times 10^{-6}$ hPa l/s.
- As an alternative to the helium leak test, the pressure drop method can be used, see **Checking gas path leak tightness** on page 105.
 - For this purpose, a test pressure of $p_e \sim 400$ hPa for a test duration of 15 min should be applied.
Within this time, the pressure must not drop more than 1 hPa.
- Every time the sample gas path is opened, it needs to be pre-rinsed before you power-up the power supply. That way, any explosive gas/air mixture which might be present should be removed.
 - Purge gas: nitrogen
 - Purge gas volume: 5 times the volume of the gas paths
 - Purge gas flow rate: approx. 30 l/h
 - Purge duration: at least 3 min

Important instructions for explosion-proof design in degree of protection II 3G

Visual inspection

- If the viewing glass is damaged to the point that the IP65 housing protection is no longer met, the gas analyzer must be decommissioned, secured against recommissioning and repaired.
- If the housing is damaged by UV radiation to the point that the housing protection IP 65 is no longer maintained, the gas analyzer must be decommissioned, secured against recommissioning and repaired.

Replacing the battery

- The battery may only be replaced in a non-hazardous atmosphere.
- Only the original battery may be used as a spare: lithium button cell 3 V Varta type no. 6032.

... 6 Commissioning

Failure of instrument air supply

It must be ensured that the gas supply to the analyzer module is shut off if the instrument air supply fails.

This is generally ensured by the installation of a pneumatic shut-off valve in the combustion gas supply line (refer to **Shut-off valve in the combustion gas supply line** on page 31); this valve must be controlled by the instrument air supply in such a way that, should it fail (and therefore, also in the event of failure of the continuous purging of the housing) the combustion gas supply is automatically shut off (refer to **Housing purge with Fidas24** on page 34).

If such a pneumatic shut-off valve is not installed, the following precautions and measures must be taken:

- The Overall Status or the "Failure" status of the gas analyzer must be monitored.
- If the status appears, the cause must be verified in the gas analyzer on site:
 - if the gas analyzer is not in operation (for example as a result of a voltage failure), the operating gases must be shut off.
 - If the gas analyzer is in operation, an adequate instrument air supply must be verified. If this is the case, the status messages must be verified. If this is not the case, proceed as follows:
 1. Shut off the combustion gas supply.
 2. Restore the instrument air supply.
 3. Purge gas analyzer for 20 minutes.
 4. Turn on combustion gas supply.
 5. Gas analyzer starts automatically.

Note for measuring combustion gases

When measuring combustion gases, it must be made sure that in case of a failure of the instrument air supply or of the analyzer module itself the sample gas supply to the analyzer module is shut off and the sample gas path is purged with nitrogen.

7 Operation

Safety instructions

When safe operation can no longer be assured

If it is apparent that safe operation is no longer possible, the device should be taken out of operation and secured against unauthorized use.

The possibility of safe operation is excluded:

- If the device is visibly damaged,
- If the device no longer operates,
- After prolonged storage under adverse conditions,
- After severe transport stresses.

LCD indicator

Note

For detailed information on the operation and parameterization of the device, consult the associated operating instructions (OI)!

Note

All representations of the LCD indicator in these Commissioning Instruction are examples.

The indications on the IED will usually differ from this.

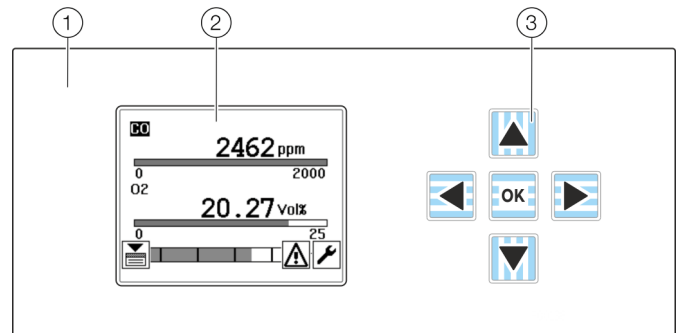

① LCD indicator

② LCD display

③ Operating buttons for menu navigation

Figure 49: LCD indicator on the device

The gas analyzer is operated via the LCD indicator on the device.

LCD display in measurement mode

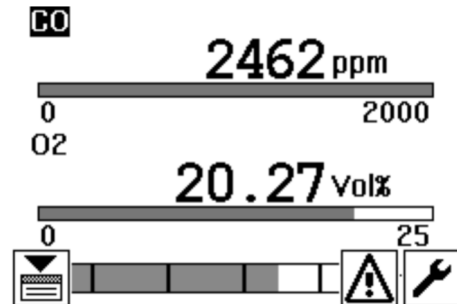

Figure 50: LCD display in measurement mode (example)

In measurement mode, the LCD display displays the name, the measured value in numbers and the physical unit of the measured value for each sample component.





If the name of the sample component flashes alternately with the inverted display, this signals that the measured value is outside the measuring range limits.

Status icons provide information on the operating condition of the gas analyzer.





... 7 Operation

... LCD indicator

Status Icons

Icon	Description
	An automatic calibration is in progress, see Operating instruction. The icon also appears in menu mode in the menu title line, see LCD display in menu mode on page 110.
	A status message is active, see " Diagnosis / error messages " in the operating instruction.
	The status signal 'Maintenance required' is active, see " Diagnosis / error messages " in the operating instruction. The icon also appears in menu mode in the menu title line, see page 110.
	The status signal 'Failure' is active (see " Diagnosis / error messages " in the operating instruction) or the maintenance switch (see Operating instruction) is set to 'On'. The icon is flashing. The icon also appears in menu mode in the menu title line, see LCD display in menu mode on page 110.
	The configuration has been saved. The icon is flashing. Do not turn off the power supply of the gas analyzer while the icon is displayed!

Key functions in measurement mode

Button	Description
	Toggle to display each individual measured value; in addition to the number display, an analog bar with an indication of the measuring range limits appears on this indicator.
	Decrease or increase the contrast of the LCD display. If a status message is active: First, press the  button.
OK	Switch to menu mode (see 110).
	If a status message is active  : Press the button to display the message list (see "Diagnosis / error messages" in the operating instruction).

Number of decimal places

When displaying the measured value in physical units (such as ppm), the number of decimal places depends on how large the span of the set measuring range is.

Measuring span	Decimal places
≤ 0,05	5
≤ 0,5	4
≤ 5	3
≤ 50	2
≤ 500	1
> 500	0

The number of decimal places when setting the parameters is the same as in the display in measuring mode.

LCD display in menu mode

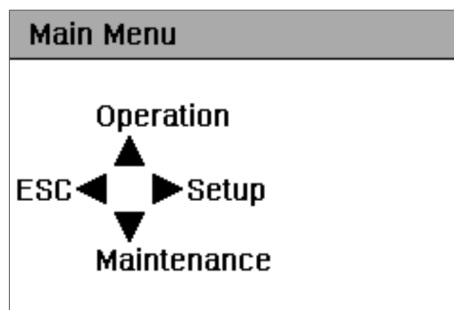

















Figure 51: Main menu

Structure of the menu

Each menu (see **Menu Overview** on page 113) from the main menu contains a maximum of three menu items ('3-tier menu').

Each menu item is assigned to one of three buttons ,  and , therefore each menu item can be selected directly. The  button is always used to return to the next higher menu.

The most commonly needed functions are arranged in the menu in a way that they can be called up by pressing each of the keys repeatedly:

- ' Operation /  Calibration /  Manual Calibration /  Zero point / Single point'
- ' Setup /  Calibration Data /  Test gas set points'
- ' Maintenance /  Diagnosis /  Device status /  Status messages'

Button functions in menu mode

Button	3-tier menu
▲ ► ▼	Select menu item
◀	Return to the next higher menu
OK	Return to measurement mode
Component list	
▲ ▼	Select component
► or OK	Call up selected component for editing
◀	Return to the next higher menu
Parameter list ('Selector')	
▲ ▼	Select parameter
►	Call up value change
OK	Accept all displayed values and return to the next higher menu
◀	Discard all displayed values and return to the next higher menu
Change in value	
▲ ▼	Change selected item
►	Select items to be changed
OK	Confirm changed value and return to the parameter list
◀	Discard changed value and return to the parameter list

Password protection

Access to the calibration as well as to the menus where the configuration of the device can be changed can be password-protected. Password protection is not activated at the factory.

Password protection variants:

- Access to calibration can be excluded from password protection.
- Access to all device functions can be password-protected (for devices with SIL certification).

Note

For security reasons it is recommended, to set a password.

Configure password

The password is set in the Configurator in menu 'Options – Password...'. It consists of a 4-digit number; each of the digits may only assume the values of 1, 2 and 3 (for example: '1213'. The setting '0000' means that password protection is not enabled.

The screenshot shows a 'Password' dialog box with the following elements:

- Title Bar:** 'Password' with a close button (X).
- Input Fields:**
 - 'New Password' field containing 'xxxx'.
 - 'Confirm Password' field containing 'xxxx'.
- Options:**
 - Activate factory-set password protection
 - Activate password protection for all functions EXCEPT calibration menu
 - Activate password protection for all functions (SIL)
- Buttons:** 'Ok' and 'Cancel' buttons at the bottom.

... 7 Operation

... LCD indicator

Enter password

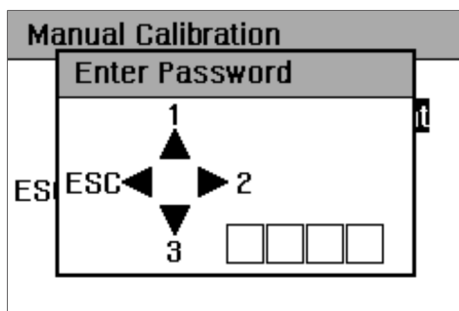

Figure 52: Password entry

As soon as the user wants to access a password-protected menu or a password-protected value change, password entry is prompted.

For this purpose, as shown on the LCD display, the digits 1, 2 and 3 are assigned to three buttons ▲, ► and ▼.

Example

If the password set is '1213', the user needs to push the buttons ▲, ►, ▲ and ▼ one after the other. Each push of a button is acknowledged by displaying the '*' symbol.

The password entered remains active until the user returns to measuring mode or until the gas analyzer automatically switches to measuring mode through the time-out function.

Time out function

If the user does not press a button for more than 5 minutes while selecting menu items, the gas analyzer automatically switches back to measurement mode (see **LCD display in measurement mode** on page 109).

The time-out function is disabled as soon as the user changes the value of a parameter or starts a calibration.

Status messages on the LCD display

Menu path

'▼ Maintenance / ▼ Diagnosis / ▼ Device Status / ▼ Status Messages'

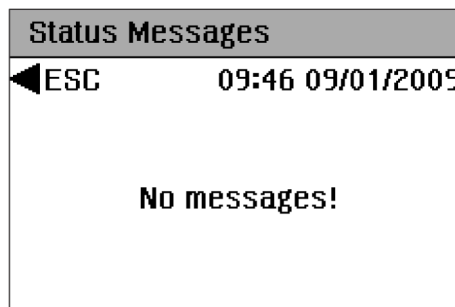

Figure 53: Menu 'Status Messages'

When a status message is active, the message list display is called up directly by pressing the ▼ button once.

Message list and detailed view

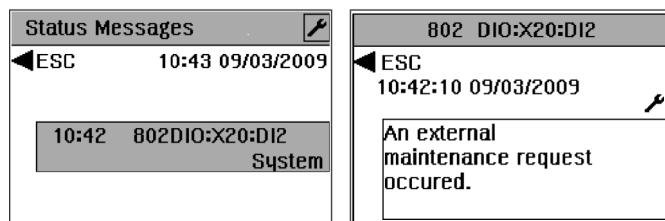

Figure 54: List of status messages and detailed view

The message list with the short text of the status messages is displayed in the 'Status Messages' menu.

By pressing the ► button, the detailed view of the individual status messages is displayed; in the detailed view, the time and date of occurrence, as well as cancellation or acknowledgment of the status message are displayed.

Note

For a detailed description of errors and information regarding troubleshooting, refer to the chapter titled "Diagnosis / Error messages" in the operating instruction.

Menu Overview

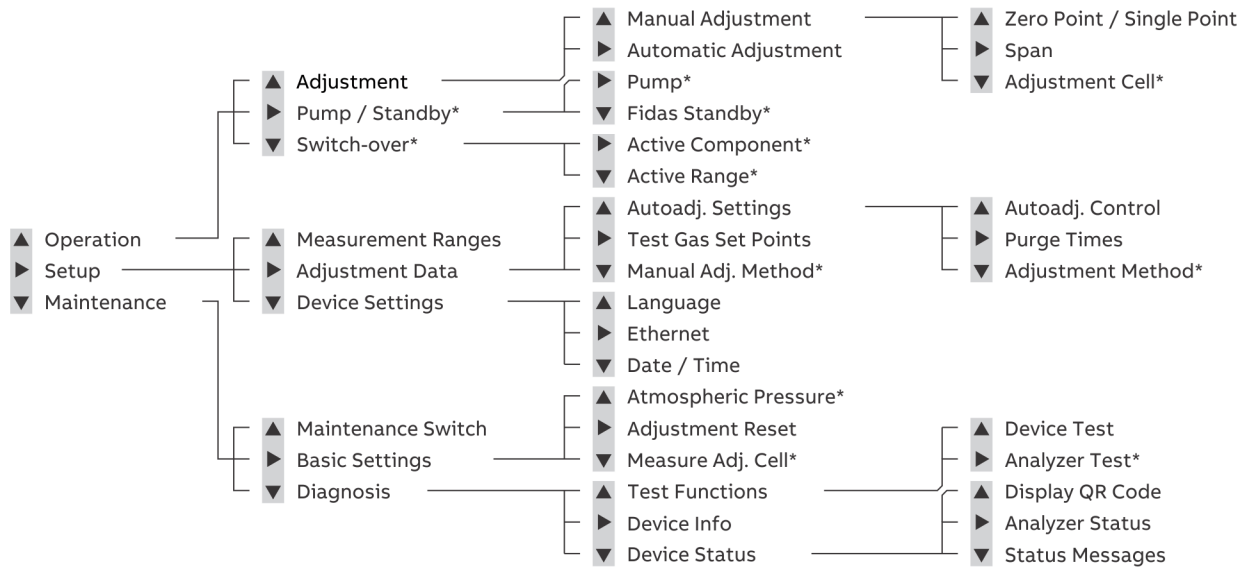

* This menu depends on the configuration of the gas analyzer

Figure 55: Menu overview

Notes on the operating concept

The operating concept of the gas analyzer requires that the functions needed in normal operating mode are operated and configured directly on the device.

On the other hand, those functions that are seldom needed, for example when commissioning the device, are named, configured and then loaded into the gas analyzer offline using the ECT 'EasyLine Configuration Tool' software tool, also referred to as the 'Configurator' in this instruction.

... 7 Operation

Communication between gas analyzer and computer

Ethernet communication

The communication between the gas analyzer and the computer runs via an Ethernet connection either as a point-to-point connection or via a network.

The Ethernet connection enables communication

- using the test and calibration software Optima TCT Light,
- using the ECT configuration software,
- for QAL3 data transfer if the 'QAL3 monitoring' option is integrated in the gas analyzer,
- For reading the measured values and calibration and control of the gas analyzer via the Modbus® TCP/IP protocol.

Establishing communication between the gas analyzer and the computer

To establish the communication between the gas analyzer and the computer, the following steps must be performed in particular:

1. Check and set the TCP/IP parameters in the gas analyzer and the computer.
2. Establish and test the Ethernet connection.
3. Establish communication between the gas analyzer and the computer.

Check the TCP/IP parameters in the gas analyzer and in the computer

For operation of the configurator, the TCP/IP parameters must be checked in both the gas analyzer and the computer and changed, if necessary.

In the case of a point-to-point connection, the IP addresses in the gas analyzer and in the computer must be matched.

Example:

Gas analyzer: 192.168.1.4,

Computer: 192.168.1.2

Note

If the gas analyzer is connected to a network without a DHCP server, then the parameter 'DHCP' should be set to 'off'.

This also applies if the gas analyzer is not connected to a network via Ethernet.

This is to prevent the gas analyzer from continuously attempting to establish a network connection.

Setting the IP address

Menu Path

► Setup / ▼ Device Settings / ► Ethernet'

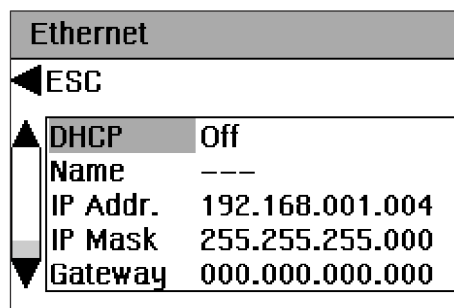

Figure 56: Menu 'Ethernet'

Function

The Ethernet connection enables communication

- using the ECT software tool and Optima TCT Light,
- for QAL3 data transfer if the 'QAL3 monitoring' option is integrated in the gas analyzer,
- for reading the measured values and for adjusting and controlling the gas analyzer via the Modbus TCP/IP protocol.

Parameters

It depends on the DHCP settings what parameters need to be integrated:

DHCP setting	Parameter
DHCP on	Network name (max. 20 characters, no empty and special characters),
DHCP off	IP address, IP address mask and IP gateway address.

The network name can only be changed in the Configurator. The default network name consists of 'EL3K' and the last six characters of the MAC address (for example, 'EL3KFF579A').

If the parameter 'DHCP' is set to 'off', the Ethernet configuration is set to the default configuration (default IP address) in order to avoid unintentional assignment of an IP address from a DHCP pool.

Addresses

The IP address, IP address screen and IP gateway address need to be queried from the system administrator.

Note

The address bits variable from the address screen may not be set to 0 or 1 (broadcast addresses).

MAC address

The 12 character MAC address is unique worldwide and is stored in the device during manufacture. It cannot be changed.

Setting the IP address in the computer

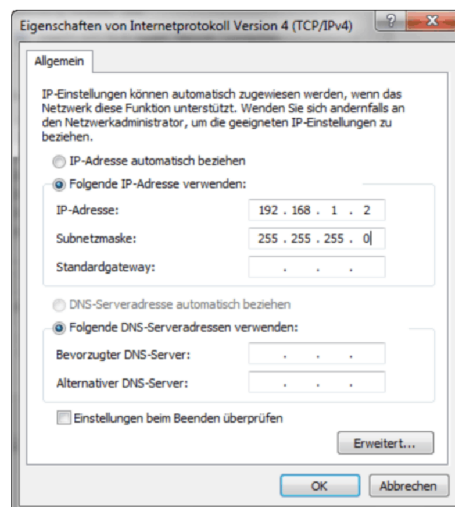

Figure 57: Microsoft Windows® IP properties (example)

1. Call up 'Start' → 'System control' → 'Network and release center'.
2. Click on 'Change adapter settings'.
3. Right-click on 'Ethernet' (Windows 10®) or 'Local Area Connection' (Windows 7®) → 'Properties'
4. in the network tab → double-click on 'Internet Protocol Version 4 (TCP/IPv4)'
5. In the 'General' tab, you can configure the IP settings (see) appropriate for the configuration of the gas analyzer and confirm the settings by clicking on 'OK'.

Establishing and testing the Ethernet connection

Cables

The cables are standard Ethernet cables and are in the scope of delivery of the gas analyzer.

Testing the Ethernet connection

1. Call up 'Start' → 'Input request'.
2. Enter 'ping IP-Adresse' (along with the IP address of the gas analyzer) and press the Enter button.

If the connection is OK, the gas analyzer reports: 'Response from IP address: Bytes=32 Time<10ms TTL=255'
(the numbers are device-specific).

If the message 'Request timeout' appears, the connection is not OK.

The network name of the gas analyzer can also be entered instead of the IP address.

... 7 Operation

... Communication between gas analyzer and computer

Establish communication between configurator and gas analyzer

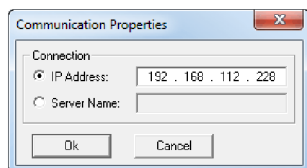



Figure 58: 'Communication Properties' menu in ECT

The communication between the configurator and the gas analyzer is established in the 'Options / Communication Properties...' menu or by clicking on the  icon.

Either the IP address or the network name (server name) of the gas analyzer should be entered.

Receiving configuration data

Once communication is established, configuration data can be received from the gas analyzer.

'File / Receive Data' menu or  icon.

Sending configuration data

Once the configuration data has been processed, it can be sent to the gas analyzer.

The configuration is active after an automatic restart of the gas analyzer.

Menu 'File / Send Data' or  icon.

Saving configuration data

The gas analyzer configuration data can be stored on the computer.

The saved configuration file can be processed later and sent to the gas analyzer.

'File / Save As...' menu or  icon.

Release of communication via Modbus® TCP/IP

In the EL3000, communication via Modbus® TCP/IP is blocked on all Ethernet interfaces by default.

Note

The Modbus® protocol is an unsecured protocol (in the meaning of IT security or cybersecurity), as such the intended application should be assessed before implementation to make sure that the protocol is suited.

Release communication via Modbus® TCP/IP

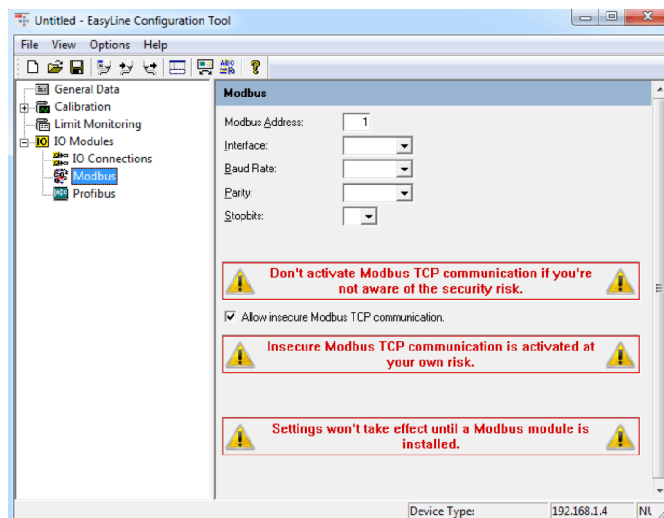

Figure 59: Modbus configuration in ECT

Implement the following steps to release communication via Modbus TCP/IP:

1. Select '...\IO Modules\Modbus' in the menu tree of the ECT Controller.
2. Select the ' Allow insecure Modbus TCP communication' checkbox.
3. Set the required Modbus parameters, save the settings and transfer them to the gas analyzer.
4. Communication via the Modbus TCP/IP protocol has now been released.

Note

You will find detailed information regarding the Modbus® in the description of the interface 'COM/EL3000/MODBUS'.

8 Maintenance

Safety instructions

WARNING

Risk of injury

Risk of injury due to maintenance work being carried out incorrectly.

The work described in this chapter require special knowledge and may require work to be done on the gas analyzer while it is open and under voltage!

- Maintenance work on the gas analyzer should be performed by qualified and specially trained personnel only !

Note

For detailed information on the maintenance of the device, consult the associated operating instructions (O)!

9 Decommissioning

Decommissioning the gas analyzer

In the case of a temporary shutdown:

1. Shut off the sample gas.
2. Purge the gas lines and gas feed paths in the gas analyzer with dry air or nitrogen for at least 5 minutes.
3. Switch off the gas analyzer power supply.

In the case of a long-term shutdown, carry out the following in addition:

4. Remove the gas lines from the gas analyzer ports. Tightly seal the gas ports.
5. Disconnect the electrical leads from the gas analyzer.

... 9 Decommissioning

Fidas24 – Shutting down the gas analyzer

In the case of a temporary shutdown:

1. Shut off the sample gas supply at the sampling point.
2. Purge the sample gas line with nitrogen for at least 5 minutes, from the sampling point.
3. Set the gas analyzer to standby mode, refer to **Fidas24 – Standby / Restart** on page 104.

In case of corrosive and combustion gases set the gas analyzer to standby operation with detector purging.

4. Shut off combustion air supply and combustion gas supply.

In the case of a long-term shutdown, carry out the following in addition:

5. Shut off instrument air supply.
6. Switch off the gas analyzer power supply.
7. Remove the gas lines from the gas analyzer ports. Tightly seal the gas ports.
8. Disconnect the electrical leads from the gas analyzer.

Packing the Gas Analyzer

1. Remove adapters from the gas ports and tightly seal the gas ports.
2. If the original packaging is not available, wrap the gas analyzer in bubble wrap or corrugated cardboard. For overseas shipment, always add a desiccant (e.g., silica gel) and hermetically seal the gas analyzer plus desiccant in a layer of polythene that is 0.2 mm thick. The amount of drying agent should be appropriate for the package volume and the expected shipping duration (at least 3 months).
3. Pack the gas analyzer in an adequately sized box lined with shock-absorbing material (foam or similar). The thickness of the shock-absorbing material should be adequate for the weight of the gas analyzer and the mode of dispatch. When shipping overseas, additionally line the box with a double layer of bitumen paper.
4. Mark the box as "Fragile Goods".

Note

If the device is returned to ABB Service (e.g. for repair), the following points must be observed:

- It is essential that the gases that were introduced into the gas analyzer are specified on the return form.
- See the information in **Returning devices** on page 119!

Transport-/Storage temperature

-25 to 65 °C

Returning devices

Use the original packaging or a secure transport container of an appropriate type if you need to return the device for repair or recalibration purposes.

Fill out the return form (see **Return form** on page 121) and include this with the device.

In accordance with the EU Directive governing hazardous materials, the owner of hazardous waste is responsible for its disposal or must observe the following regulations for shipping purposes:

All devices delivered to ABB must be free from any hazardous materials (acids, alkalis, solvents, etc.).

Address for the return:

ABB Automation GmbH

Service Analystechnik – Parts & Repair

Stierstädter Straße 5

60488 Frankfurt, Deutschland

Fax: +49 69 7930-4628

E-Mail: repair-analytical@de.abb.com

www.abb.de/prozessautomatisierung-service

10 Recycling and disposal

Note



Products that are marked with the adjacent symbol may **not** be disposed of as unsorted municipal waste (domestic waste).

They should be disposed of through separate collection of electric and electronic devices.

This product and its packaging are manufactured from materials that can be recycled by specialist recycling companies.

Bear the following points in mind when disposing of them:

- As of 8/15/2018, this product will be under the open scope of the WEEE Directive 2012/19/EU and relevant national laws (for example, ElektroG - Electrical Equipment Act - in Germany).
- The product must be supplied to a specialist recycling company. Do not use municipal waste collection points. These may be used for privately used products only in accordance with WEEE Directive 2012/19/EU.
- If there is no possibility to dispose of the old equipment properly, our Service can take care of its pick-up and disposal for a fee.

11 Specification

Note

The device data sheet is available in the ABB download area at www.abb.com/analytical.

12 Additional documents

Note

All documentation, declarations of conformity, and certificates are available in ABB's download area.

www.abb.com/analytical

13 Appendix

Return form

Statement on the contamination of devices and components

Repair and/or maintenance work will only be performed on devices and components if a statement form has been completed and submitted.

Otherwise, the device/component returned may be rejected. This statement form may only be completed and signed by authorized specialist personnel employed by the operator.

Customer details:

Company: _____

Address: _____

Contact person: _____

Telephone: _____

Fax: _____

Email: _____

Device details:

Type: _____

Serial no.: _____

Reason for the return/description of the defect: _____

Was this device used in conjunction with substances which pose a threat or risk to health?

Yes No

If yes, which type of contamination (please place an X next to the applicable items):

biological

corrosive / irritating

combustible (highly / extremely combustible)

toxic

explosive

other toxic substances

radioactive

Which substances have come into contact with the device?

1. _____

2. _____

3. _____

We hereby state that the devices/components shipped have been cleaned and are free from any dangerous or poisonous substances.

Town/city, date

Signature and company stamp

Trademarks

Extran is a registered trademark of Merck KGaA, Darmstadt, Germany

Modbus is a registered trademark of Schneider Automation Inc.

PROFIBUS, PROFIBUS PA and PROFIBUS DP are registered trademarks of PROFIBUS & PROFINET International (PI)

Windows is a registered trademark of Microsoft Corporation.

Notes

ABB Measurement & Analytics

For your local ABB contact, visit:
www.abb.com/contacts

For more product information, visit:
www.abb.com/analytical

We reserve the right to make technical changes or modify the contents of this document without prior notice. With regard to purchase orders, the agreed particulars shall prevail. ABB does not accept any responsibility whatsoever for potential errors or possible lack of information in this document.

We reserve all rights in this document and in the subject matter and illustrations contained therein. Any reproduction, disclosure to third parties or utilization of its contents – in whole or in parts – is forbidden without prior written consent of ABB.