

## ABB DC drives

DCS550, 20 A – 1,000 A, 230 V<sub>AC</sub> – 525 V<sub>AC</sub>, – 500 kW

The OEM machine manufacturing market places high demands on modern DC-drives. With its compact dimensions and robust technology, the DCS550 is an ideal drive solution for this market – both in new installations or as a replacement for older analog devices. Integrated “winder”, high-performance field supply and various interfaces provide machine manufacturers with a maximum of flexibility in terms of machine integration. In the DCS550, the extremely user friendly operational concept of the DCS400 has been consistently refined and optimized based on practical experience.



### DCS550 – The highlights

- Compact dimensions
  - For installations with limited space
- Integrated high performance three phase field exciter up to 35 A
  - Fits all available motors without additional installations
- “Winder” with commissioning assistant
  - For easy and fast adaption to applications
- Different Fieldbus interfaces (incl. EtherCAT, Profinet...)
  - For easy integration into automation
- Additional PID-controller
  - For overriding control functions (e. g. pressure- or level control)
- Adaptive programming with Drive AP, ABB’s graphical PC-tool
  - For easy implementation of additional functions
- Various start-up assistants and auto-tune functions
  - For fast commissioning
- Large control panel
  - For straight forward and self-explanatory operation
- Rugged design
  - For rough environments, high reliability
- Worldwide service
  - Local service in more than 60 countries

### DCS550 – Extensive applications

- Extruders
- Sugar centrifuges

- Wire drawing machines
- Coating lines
- Printing machines
- Presses
- Tools machines main drives
- Food processing machines
- Woodworking (wooden products and MDF industry)
- Retrofit of analog DC-technology

### Modern DC-drives – More up-to-date than ever

Today, DC-drive technology is more up-to-date than ever. Their attractive cost-performance ratio and functional advantages such as high torque at low speed, light weight and low power loss turn DC-drives into the preferred solution for many applications. As far as innovation is concerned ABB’s DC-drives match the same high standards as ABB’s AC-drives.

### Easy upgrade of installed older converters

The machines are frequently still in very good condition but spare parts and know-how for the installed power electronics are no longer available. With the DCS550, existing machines can be kept in operation by replacing the old drive. Short downtimes and low costs for the retrofit are additional advantages of an upgrade of existing machinery.

# ABB DC drive DCS550

## Simplicity as a principle

The DCS550 is based on the well-proven concept of ABB's digital converters, which is highly appreciated around the world for its simplicity. Each operating step is displayed explicitly and easily comprehensible for the user.

The basic version of the DCS550 is already equipped with a large number of standard hardware interfaces like an encoder, an analog tachogenerator and four analog input devices. Since the basic unit includes all important functions nearly all applications are covered – options are not necessary. The one-volume documentation provides comprehensive information on the unit, firmware and hardware. The guided start-up and complementary support functions reduce start-up times to a minimum. The grouped structure of the parameters provides easy and clearly arranged navigation within the various features and functions. Error messages and help texts are displayed in plaintext in the user's native language. The reduced need for training is an additional advantage created by the synergies and similarities with ABB's DCS800 converter and ABB AC-drives.

## Control panel: High level of convenience included

The assistant control panel is part of the basic unit. It offers a multi-language alpha-numeric display (EN, DE, ES, FR, IT)

with multilingual help function. The large graphic display allows the user to freely select actual and set values. Another additional advantage: the user can call up a list of all changed parameters. The control panel can also store parameters as a security backup or copy them for use in other converters.

## Fieldbus: Pluggable flexibility

The pluggable fieldbus options allow the connection to most automation systems. A single cable with two twisted conductors replaces complex conventional cabling while reducing cost and increasing the reliability of the entire system.

- Profibus
- CANopen
- DeviceNet
- ControlNet
- Modbus RTU
- Ethernet IP
- Modbus TCP
- EtherCAT
- ProfiNet

## I/O extension modules:

The pluggable I/O modules extend the basic I/O's.

- RDIO-01 Digital extension module 3 x DI, 2 x DO
- RAIO-01 Analogue extension module 2 x AI, 2 x AO

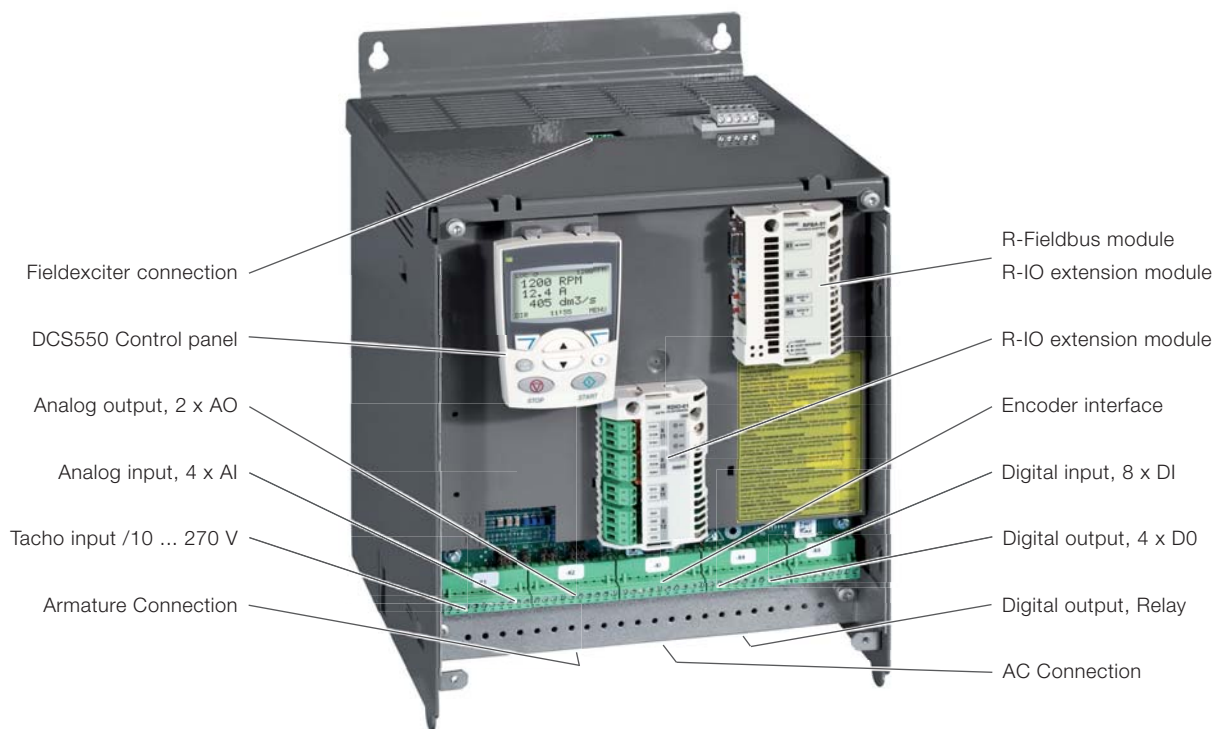

DCS550 converter module

# Drive tools

## Useful features

### DriveWindow Light

The user-friendly start-up and maintenance tool for the world of ABB-drives supports both ABB's DC-drives and AC-drives. DriveWindow Light is a PC-software for easy and fast start-up and maintenance of DCS550 converters and is part of the basic package. In offline-mode, all parameters can be set from the user's office desk. The parameter browser can both display and save parameters on the computer. A comparison feature can compare and align current values with a stored set of parameters. With the "Local"-feature, the drive can be controlled, as well. At the same time, up to four display values can be visualised graphically. DriveWindow Light also includes an assistant for guided start-up, winder functions as well as the AP-tool for block programming.

### Start-up assistant

The DWL start-up assistant for the DCS550 provides valuable support during commissioning via an interactive dialogue. The individual steps of the start-up process are pre-defined in the right order and all required parameters are displayed. The "Basic"-feature captures motor and connection data and adjusts the controller automatically. The "Advanced"-feature

supports the start-up of serial communication (fieldbus) and winder functions. The context sensitive help function is always available.

### "Adaptive Programming" (AP):

Adaptive Programming is included in the basic package. With the help of 16 functional blocks users can develop, test and document their own programs easily in a graphic manner. The „Adaptive Programming“ (AP) function allows the implementation of additional features. Modifications can be configured with either the control panel or with the help of the graphic interface of DriveWindow Light AP. The main features of DriveWindow Light AP are:

- 16 programmable function blocks
- Available functions:
  - Logical: AND, OR and XOR
  - Mathematical: add, mul, div, abs, max and min
  - Other: timer, switch, comparator, filter, SR, PI and user-defined warnings or faults
- Freely definable execution order
- Easy documentation

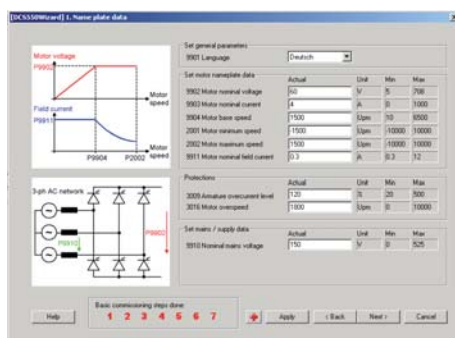

Start-up Assistant

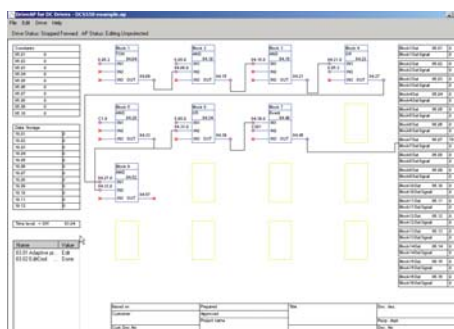

Adaptive Programming

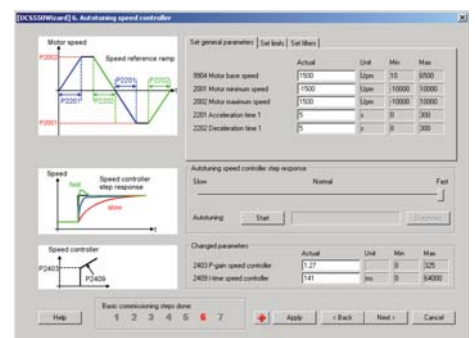

Speed Controller Autotuning

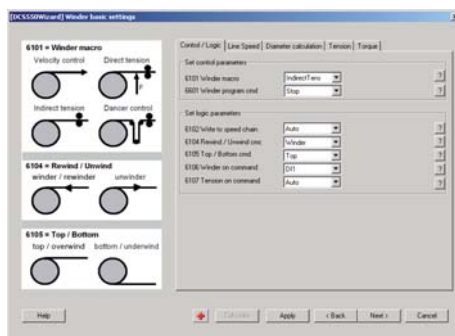

Winder Macros

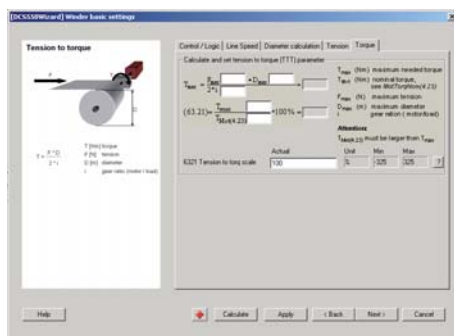

Winder Assistant

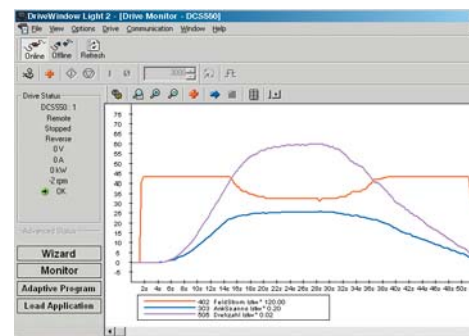

Trending

# Integrated winder function

## Integrated winder functions

The DCS550 is equipped with a winder function with pre-defined macros for the four most commonly used winder types:

### Velocity control

Calculates the diameter and rotation speed set value. The diameter is used to adjust the speed controller to all winding sizes. There is no tension control. All other macros are included in this basic structure.

### Indirect tension control

Controls the tension with the help of preset charts for friction and moment of inertia (open loop).

This structure provides a very robust control behaviour because no physical tension measurement is required.

### Direct tension control

Closed loop for physical value of tension  
The tension is measured with a load cell and transferred to the

drive as an analog actual value. The DCS550 is equipped with a free PID-controller that can be integrated into the control loop with the "Tension Control" macro.

### Dancer control

Controls the tension with the weight of the dancer roll (closed loop).

The dancer has to be kept in the right position with additional speed set values. The PID-controller of the DCS550 can also control the positioning of the dancer roll. The position of the dancer roll is transmitted to the controller as an analog actual value.

### Commissioning assistant

For an easy winder set-up, all different winder types can be configured and commissioned using a graphical assistant.

The assistant is part of DriveWindows Light PC-tool.

The rating for friction and inertia can be determined by auto tuning.

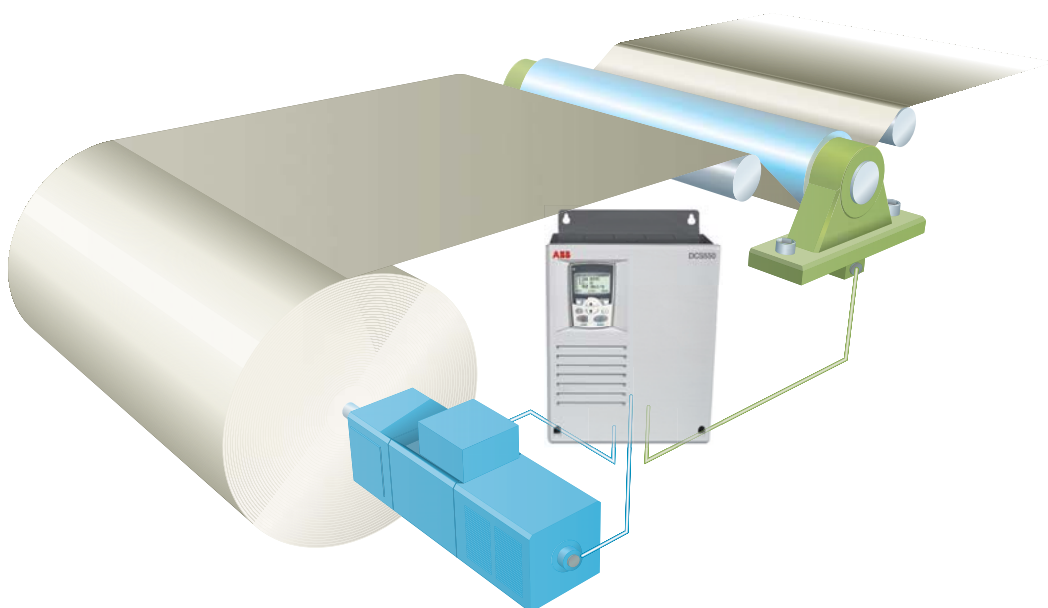

Example: direct tension control (closed loop)

# Technical data

Mains connection	
Mains	3-phase 230 V <sub>AC</sub> - 525 V <sub>AC</sub> ; -15 % / +10 %
Rated frequency	50 Hz or 60 Hz
Field exciter	
Supply voltage	Internally connected to the mains
Hardware	Completely integrated 3-phase OnBoard field exciter
Operating conditions	
Degree of protection	IP 00
EMC	Fulfilling EN 61800-3 in accordance with 3ADW 000 032
Compliance	CE, cULus
Control interfaces	
Auxiliary voltages	115 V <sub>AC</sub> , 230 V <sub>AC</sub> , 230 V <sub>DC</sub>
PC-tools	DriveWindow Light, DWL AP, start-up assistant, winder assistant, help function
DCS550 Control Panel	As standard, several languages, start-up assistant, help function
Status display	Seven-segment display as standard
Analog I/O	4 AI (15 bit + sign); 3 AO (11 bit + sign; two are freely programmable, one is fixed for armature current)
Digital I/O	8 DI, 5 DO (one for mains breaker)
Motor temperature	1 PTC
Analog tachometer input	As standard
Encoder input	As standard for 5 V and 24 V encoders
Option slots	two slots for analog and digital I/O plug-in options
Special firmware functions	
Adaptive Program	16 freely programmable function blocks
PID controller	Freely usable PID controller
Macros	10 pre-defined macros for fast commissioning
winder macros	4 pre-defined winder macros
Control and communication options	
Analog & digital plug-in options	
1 * RAIO	2 AI, 2 AO
2 * RDIO	3 DI, 2 DO each
Classic fieldbuses	
RCAN-01	CANopen
RCNA-01	ControlNet
RDNA-01	DeviceNet
RMBA-01	Modbus (RTU)
RPBA-01 Profibus	Profibus
Ethernet fieldbuses	
RECA-01	EtherCat*
RETA-01	Ethernet/IP and Modbus/TCP
REPL-01	Ethernet Powerlink*
RETA-02	Profinet*

\*= in preparation

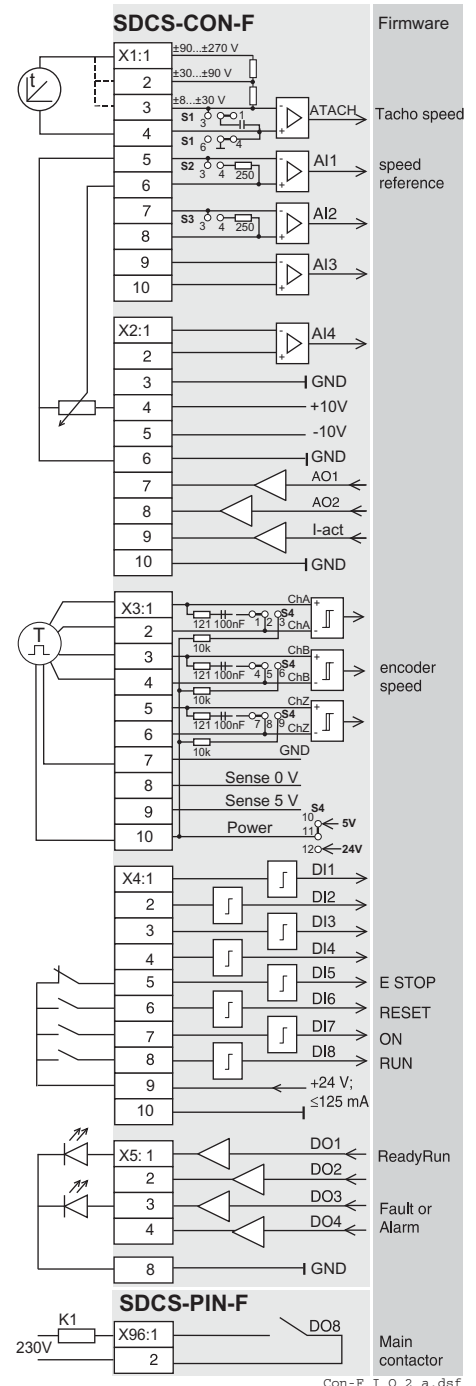

Control Connections

# Technical data, dimensions and weights

## Single bridge (2-Q Drive)

Mains [V]	I <sub>A</sub> [A]	I <sub>F</sub> [A]	Fan supply	Dimensions h x w x d [mm]	Weight [kg]	Type code	Size
230 – 525 –15 / +10 %	20	1 - 12	no fan	370 x 270 x 220	11	DCS550-S01-0020-05	F1
	45		internal			DCS550-S01-0045-05	
	65		internal			DCS550-S01-0065-05	
	90		internal			DCS550-S01-0090-05	
	135	1 - 18	115 / 230 V	370 x 270 x 270	16	DCS550-S01-0135-05	F2
	180		115 / 230 V			DCS550-S01-0180-05	
	225		115 / 230 V			DCS550-S01-0225-05	
	270		115 / 230 V			DCS550-S01-0270-05	
	315	2 - 25	115 / 230 V	459 x 270 x 310	25	DCS550-S01-0315-05	F3
	405		115 / 230 V			DCS550-S01-0405-05	
	470		115 / 230 V			DCS550-S01-0470-05	
	610	2 - 35	230 V	644 x 270 x 345	38	DCS550-S01-0610-05	F4
	740		230 V			DCS550-S01-0740-05	
	900		230 V			DCS550-S01-0900-05	

## Double bridge (4-Q Drive)

Mains [V]	I <sub>A</sub> [A]	I <sub>F</sub> [A]	Fan supply	Dimensions h x w x d [mm]	Weight [kg]	Type code	Size
230 – 525 –15 / +10 %	25	1 - 12	no fan	370 x 270 x 220	11	DCS550-S02-0025-05	F1
	50		internal			DCS550-S02-0050-05	
	75		internal			DCS550-S02-0075-05	
	100		internal			DCS550-S02-0100-05	
	150	1 - 18	115 / 230 V	370 x 270 x 270	16	DCS550-S02-0150-05	F2
	200		115 / 230 V			DCS550-S02-0200-05	
	250		115 / 230 V			DCS550-S02-0250-05	
	300		115 / 230 V			DCS550-S02-0300-05	
	350	2 - 25	115 / 230 V	459 x 270 x 310	25	DCS550-S02-0350-05	F3
	450		115 / 230 V			DCS550-S02-0450-05	
	520		115 / 230 V			DCS550-S02-0520-05	
	680	2 - 35	230 V	644 x 270 x 345	38	DCS550-S02-0680-05	F4
	820		230 V			DCS550-S02-0820-05	
	1000		230 V			DCS550-S02-1000-05	

For more information please contact:

### ABB Automation Products

Wallstadter Straße 59  
68526 Ladenburg  
Germany  
Phone +49(0)6203-71-0  
Fax +49(0)6203-71-7609  
www.abb.com/motors&drives  
E-Mail: dc-drives@de.abb.com