

Aztec AWT440

Multi-input transmitter



Measurement made easy

—
Aztec AWT440 multi-
input transmitter

Introduction

The Aztec AWT440 is a universal multi-input transmitter that uses ABB's Aztec 400 range of advanced digital sensors for monitoring the key parameters in municipal and industrial water / wastewater treatment.

The transmitter has multiple sensor capability that enables it to control and display information from up to 4 sensors.

This Operating Instruction provide installation and basic operating procedures for the Aztec AWT440 transmitter.

For information on the sensor, including installation, commissioning, operation and maintenance procedures, refer to the specific sensor manual.

For more information

Further publications are available for free download from:

www.abb.com/measurement

or by scanning this code:



Search for or click on

Aztec 440
Data Sheet

[DS/AWT440-EN](#)

Aztec AWT440 transmitter –
Commissioning instruction

[CI/AWT440-EN](#)

Aztec AWT440 transmitter –
Communications supplement

[COM/AWT440-EN](#)

Contents

1 Health & Safety	3	9 Data logging	24
1.1 Document symbols	3	9.1 Removable media	24
1.2 Safety precautions	3	9.2 SD card / USB stick insertion and removal	25
1.3 Potential safety hazards	3	9.3 Archive file types	25
1.3.1 Aztec AWT440 transmitter – electrical	3	9.4 Data files	25
1.4 Safety standards	3	9.5 Log files	26
1.5 Product symbols	4	9.6 Daylight saving	26
1.6 Product recycling and disposal (Europe only)	4		
1.6.1 End-of-life battery disposal	4	10 Password security and access level	27
1.7 Restriction of Hazardous Substances (RoHS)	4	10.1 Setting passwords	27
		10.2 Access Level	27
2 Overview	5	11 Display icons	28
		11.1 Diagnostic icons	28
3 Mechanical installation	6	11.2 Title bar icons	28
3.1 Sensor installation	6	11.3 Status bar icons	29
3.2 Transmitter installation	6	11.4 Log icons	29
3.2.1 Optional accessories	6		
3.2.2 Location	6	12 Configuration (Advanced access level)	30
3.2.3 Wall mounting	6	12.1 Calibrate	31
3.2.4 Panel mounting (optional)	7	12.2 Sensor setup	31
3.2.5 Pipe mounting (optional)	7	12.3 Device Setup	31
		12.4 Display	32
4 Electrical installation	8	12.5 Input / Output	34
4.1 Power supply connection	11	12.6 Process Alarm	36
4.2 Sensor EZLink connection	12	12.7 Media Card	37
		12.8 Communication	38
5 Easy setup	13	12.9 Device Info	38
		12.10 Analog sources and digital input / output sources	39
6 Calibration and sensor setup	13	12.10.1 Analog sources	39
		12.10.2 Digital output sources	39
7 'Hot-plugging'	14	12.10.3 Digital input sources	39
7.1 Sensor addition	14		
7.2 Sensor replacement	14	13 Specification – transmitter	40
7.2.1 Replacing the sensor with a sensor of the same type	15		
7.2.2 Replacing a sensor with a sensor of a different type	15	Appendix A – Troubleshooting	42
7.3 Sensor removal	16	A.1 Diagnostic messages	42
7.4 Device behavior on sensor removal	16		
		Appendix B – Upgrading / reloading system software	44
8 Operation	17	B.1 Upgrading system software	44
8.1 Front panel keys	17	B.2 Reloading system software	46
8.2 Operation modes	19	B.3 Fault diagnosis	46
8.3 Operator menus	19		
8.4 Operating mode	20	Appendix C – Spare parts	47
8.5 View mode	22	C.1 EZLink sensor extension cables	47
8.6 Log mode	23	C.2 Aztec AWT440 transmitter spares	47
8.6.1 Log entries	23	C.3 Optional accessories	48
		Notes	49

1 Health & Safety

1.1 Document symbols

Symbols that appear in this document are explained below:



DANGER – Serious damage to health / risk to life

This symbol in conjunction with the signal word 'DANGER' indicates an imminent electrical hazard. Failure to observe this safety information will result in death or severe injury.



WARNING – Bodily injury

This symbol in conjunction with the signal word 'WARNING' indicates a potential electrical hazard. Failure to observe this safety information will result in death or severe injury.



CAUTION – Minor injuries

This symbol in conjunction with the signal word 'CAUTION' indicates a potentially dangerous situation. Failure to observe this safety information may result in minor or moderate injury. The symbol may also be used for property damage warnings.



IMPORTANT (NOTE)

This symbol indicates operator tips, particularly useful information or important information about the product or its further uses. The signal word 'IMPORTANT (NOTE)' does not indicate a dangerous or harmful situation.

1.2 Safety precautions

Be sure to read, understand and follow the instructions contained within this manual before and during use of the equipment. Failure to do so could result in bodily harm or damage to the equipment.



WARNING – Bodily injury Installation, operation, maintenance and servicing must be performed:

- by suitably trained personnel only
 - in accordance with the information provided in this manual
 - in accordance with relevant local regulations
-

1.3 Potential safety hazards

1.3.1 Aztec AWT440 transmitter – electrical



WARNING – Bodily injury

To ensure safe use when operating this equipment, the following points must be observed:

- Up to 240 V AC may be present. Be sure to isolate the supply before removing the terminal cover.
- Normal safety precautions must be taken to avoid the possibility of an accident occurring when operating in conditions of high pressure and / or temperature.







Safety advice concerning the use of the equipment described in this manual or any relevant Material Safety Data Sheets (where applicable) can be obtained from the Company, together with servicing and spares information.

1.4 Safety standards

This product has been designed to satisfy the requirements of IEC61010-1:2010 3rd edition 'Safety Requirements for Electrical Equipment for Measurement, Control and Laboratory Use' and complies with US NEC 500, NIST and OSHA.

1.5 Product symbols

Symbols that appear on this product are shown below:

	Protective earth (ground) terminal.
	Functional earth (ground) terminal.
	Alternating current supply only.
	This symbol, when noted on a product, indicates a potential hazard which could cause serious personal injury and / or death. The user should reference this instruction manual for operation and / or safety information.
	This symbol, when noted on a product enclosure or barrier, indicates that a risk of electrical shock and / or electrocution exists and indicates that only individuals qualified to work with hazardous voltages should open the enclosure or remove the barrier.
	The equipment is protected through double insulation.
	Recycle separately from general waste under the WEEE directive.

1.6 Product recycling and disposal (Europe only)



Electrical equipment marked with this symbol may not be disposed of in European public disposal systems after 12 August 2005. To conform to European local and national regulations (EU Directive 2002/96/EC), European electrical equipment users must now return old or end-of-life equipment to the manufacturer for disposal at no charge to the user.
ABB is committed to ensuring that the risk of any environmental damage or pollution caused by any of its products is minimized as far as possible.



IMPORTANT (NOTE) For return for recycling, please contact the equipment manufacturer or supplier for instructions on how to return end-of-life equipment for proper disposal.

1.6.1 End-of-life battery disposal

The transmitter contains a small lithium battery (located on the processor / display board) that must be removed and disposed of responsibly in accordance with local environmental regulations.

1.7 Restriction of Hazardous Substances (RoHS)



The European Union RoHS Directive and subsequent regulations introduced in member states and other countries limits the use of six hazardous substances used in the manufacturing of electrical and electronic equipment. Currently, monitoring and control instruments do not fall within the scope of the RoHS Directive, however ABB has taken the decision to adopt the recommendations in the Directive as the target for all future product design and component purchasing.

2 Overview

The Aztec AWT440 multi-input transmitter uses ABB's 400 range of advanced digital sensors for monitoring the key parameters in municipal and industrial water / wastewater treatment.

Information from the sensor is sent to the transmitter via a sensor interface board. The process reading is displayed on the main page and can be displayed as a graph in the *Chart View* – refer to Section 8.5, page 22 for details of view options.

Diagnostic messages inform the user of the system status and can be logged for review. The system status can also be assessed remotely using optional MODBUS, Profibus or Ethernet communications.

Up to 4 digital sensors can be connected to the AWT440 transmitter using ABB's EZLink technology. Installation and commissioning is simplified with plug-and-play digital sensor connections and automatic sensor recognition and set-up.

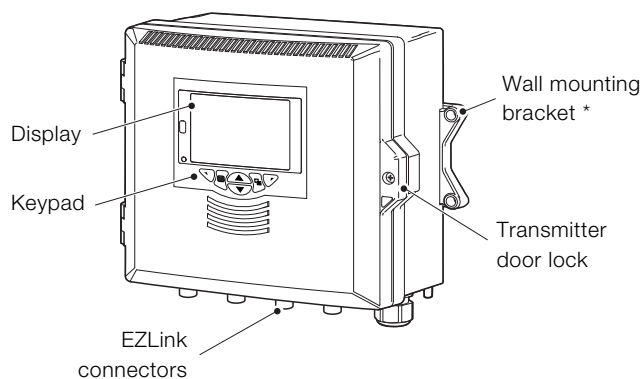

* Panel- and pipe-mount options are also available – see page 7

Fig. 2.1 Aztec AWT440 transmitter – main components

3 Mechanical installation

3.1 Sensor installation

Refer to the sensor's Operating instruction for installation procedures.

3.2 Transmitter installation

3.2.1 Optional accessories

Optional installation accessories:

- Cable gland kit
- Weathershield
- Panel-mount kit
- Pipe-mount kit

3.2.2 Location

For general location requirements refer to Fig. 3.1. Select a location away from strong electrical and magnetic fields. If this is not possible, particularly in applications where mobile communications equipment is expected to be used, screened cables within flexible, earthed metal conduit must be used.

Install in a clean, dry, well ventilated and vibration-free location providing easy access. Avoid rooms containing corrosive gases or vapors, for example, chlorination equipment or chlorine gas cylinders.

3.2.3 Wall mounting

Dimensions in mm (in.)

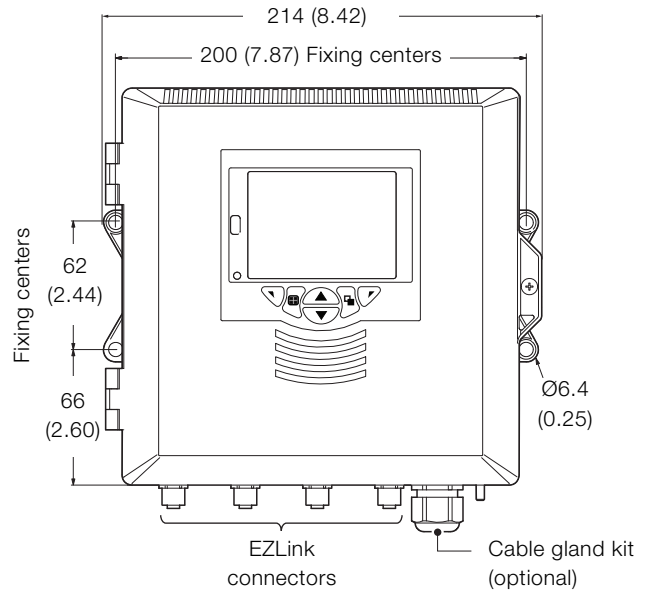

Fig. 3.2 Transmitter wall-mount

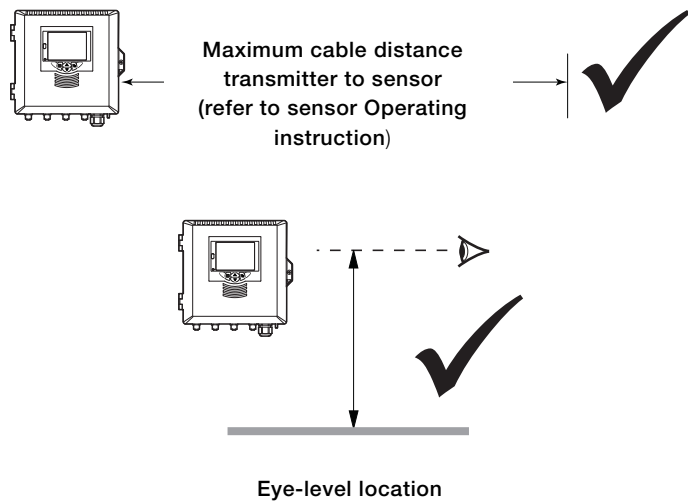
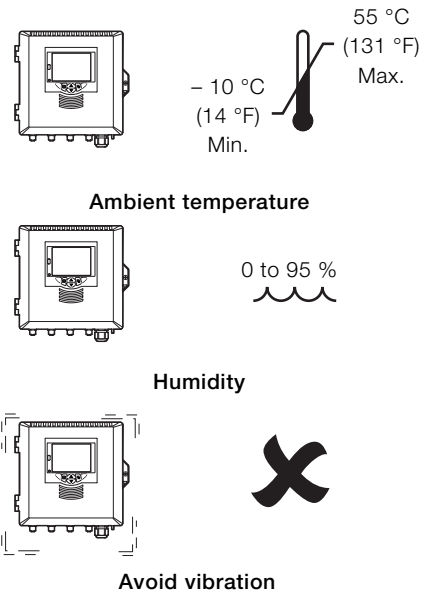

Fig. 3.1 Transmitter location



3.2.4 Panel mounting (optional)

Torque each panel clamp anchor screw to 0.5 to 0.6 Nm (4.42 to 5.31 lbf/in.)



IMPORTANT (NOTE)

Do not overtighten the screws.

Dimensions in mm (in.)

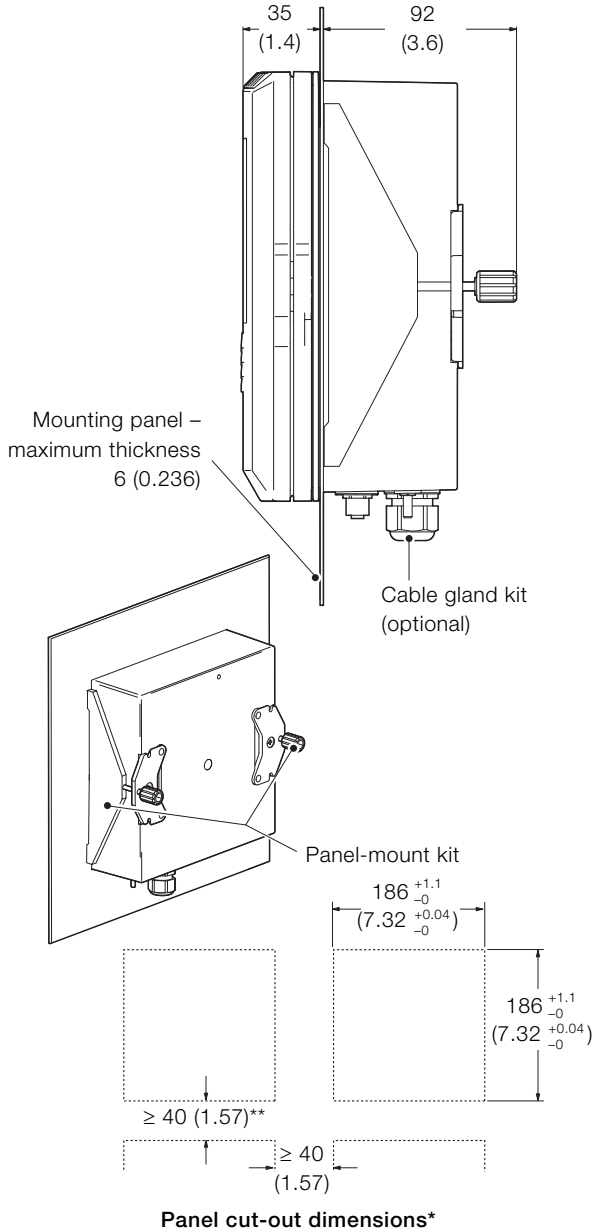

* To DIN43700

** ≥ 150 mm (6 in.) if (optional) cable glands fitted

Fig. 3.3 Transmitter panel-mount option

3.2.5 Pipe mounting (optional)

Dimensions in mm (in.)

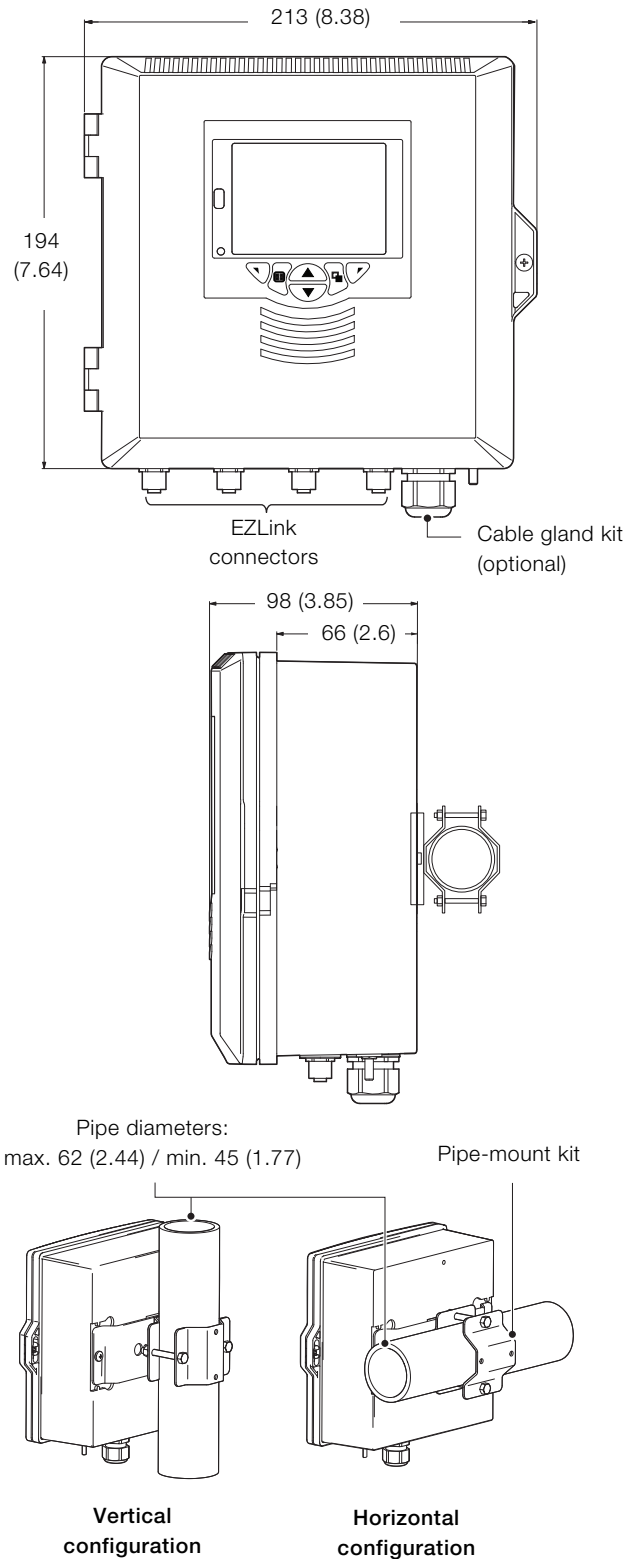

Fig. 3.4 Transmitter pipe-mount options

4 Electrical installation



DANGER – Serious damage to health / risk to life

- The transmitter is not fitted with a switch – an isolation device such as a switch or circuit breaker conforming to local safety standards must be fitted to the final installation. It must be fitted in close proximity to the transmitter, within easy reach of the operator and marked clearly as the isolation device for the transmitter.
- Remove all power from supply, relay, any powered control circuits and high common mode voltages before accessing or making any connections. Use cable appropriate for the load currents: 3-core cable rated 3 A and 75 °C (167 °F) minimum, and voltage: 100 / 240 V that conform to either IEC 60227 or IEC 60245, or to the National Electrical Code (NEC) for the US, or the Canadian Electrical Code for Canada. The terminals accept cables AWG 26 to 16 (0.14 to 1.5 mm²).
- All connections to secondary circuits must have insulation to required local safety standards. After installation, there must be no access to live parts, for example, terminals. Use screened cable for signal inputs and relay connections. Route signal leads and power cables separately, preferably in an earthed (grounded) flexible metal conduit.

USA and Canada only

- The supplied cable glands are provided for the connection of MODBUS, Profibus and Ethernet communication wiring **ONLY**.
 - The supplied cable glands and use of cable / flexible cord for connection of the mains power source to the mains input and relay contact output terminals is not permitted in the USA or Canada.
 - For connection to mains (the mains input and relay contact outputs), use only suitably rated field wiring insulated copper conductors rated min. 300 V, 16 AWG, 90C. Route wires through suitably rated flexible conduits and fittings.
-



WARNING – Bodily injury

- If the transmitter is used in a manner not specified by the Company, the protection provided by the equipment may be impaired.
 - Ensure the correct fuses are fitted – see Fig. 4.2, page 9 for fuse details.
 - Replacement of the internal battery must be carried out by an approved technician only.
 - The transmitter conforms to Installation Category II of IEC 61010.
 - All equipment connected to the transmitter's terminals must comply with local safety standards (IEC 60950, EN61010-1).
 - The DC power supply and the optional Ethernet and bus interface connectors **must** be connected to Safety Extra Low Voltage (SELV) circuits.
-

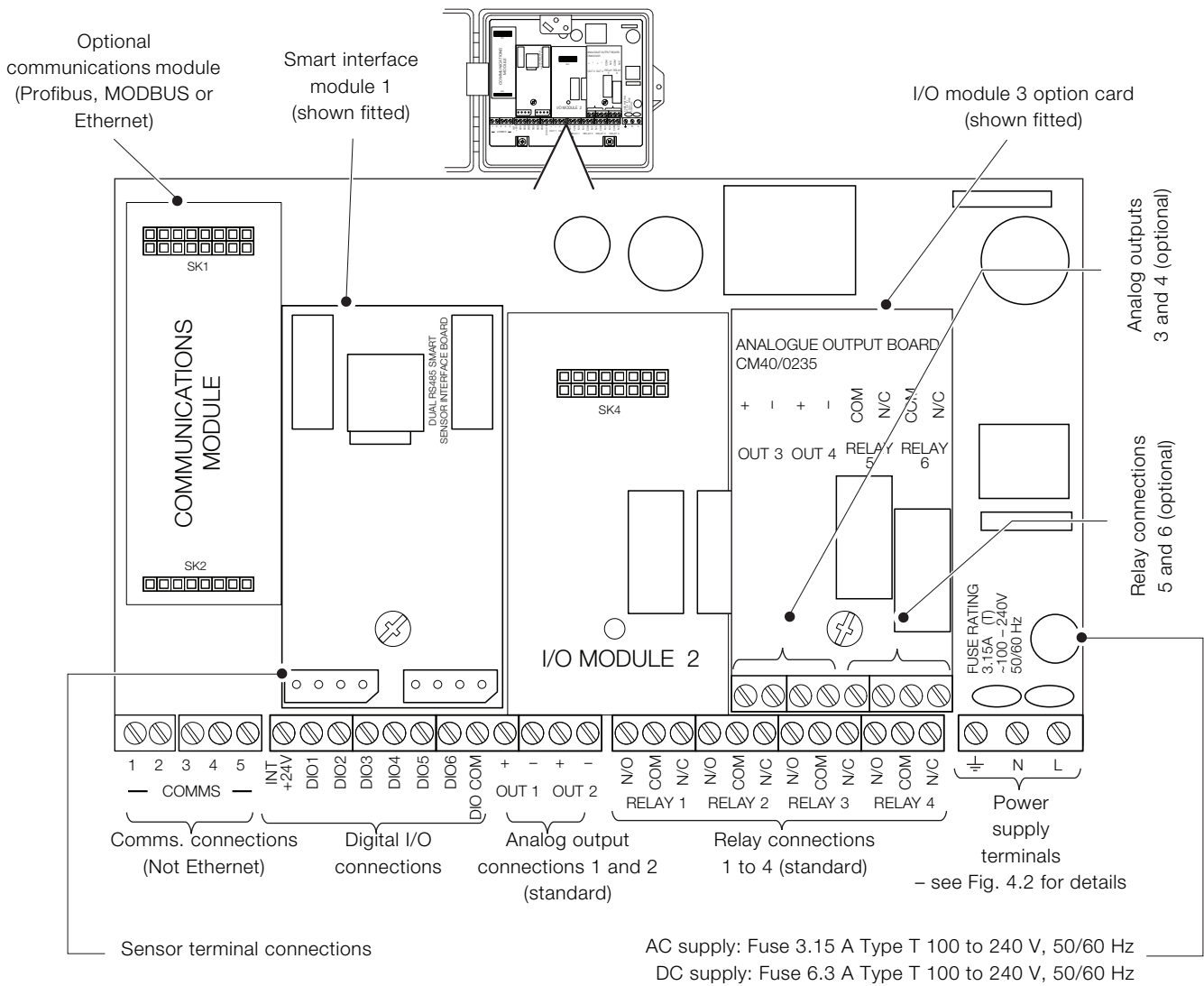

Fig. 4.1 Connections overview

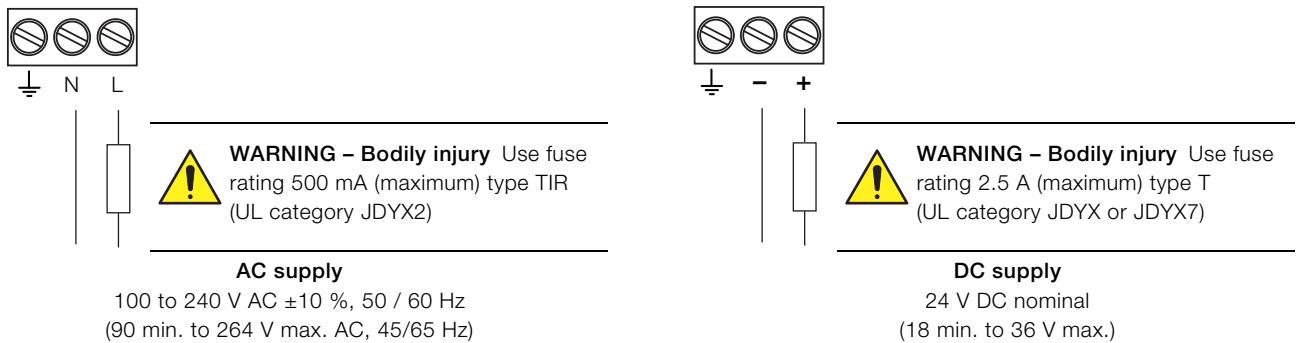

Fig. 4.2 Power supply connections and fuse details

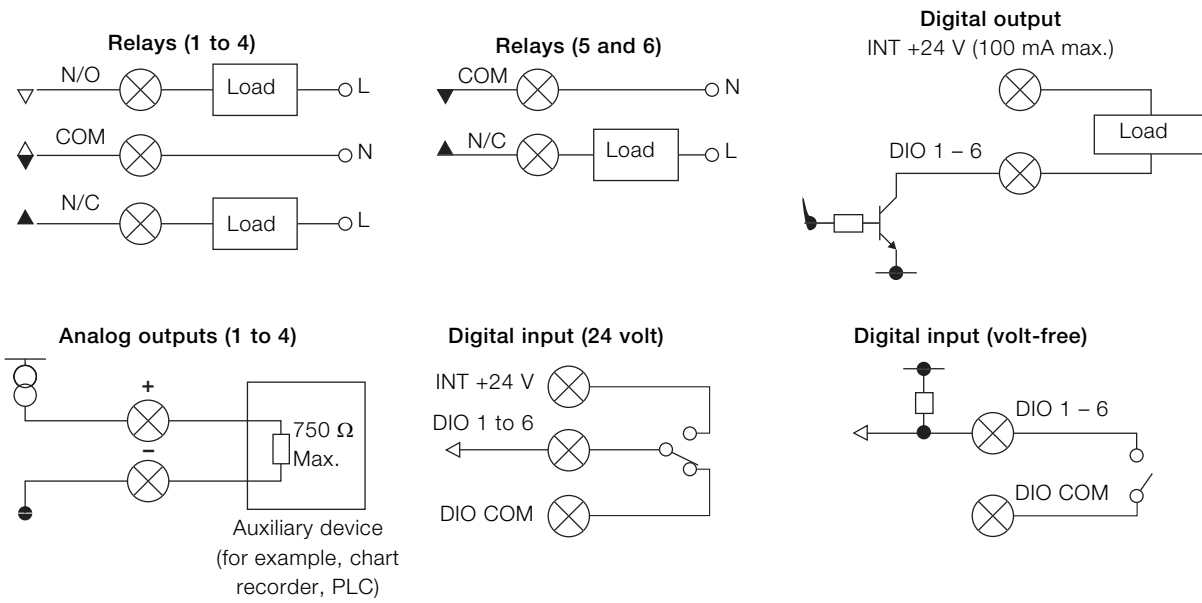

Fig. 4.3 Digital I/O, relays and analog output connections

4.1 Power supply connection



DANGER – Serious damage to health / risk to life

USA and Canada only

The supplied cable glands and use of cable / flexible cord for connection of the mains power source to the mains input and relay contact output terminals is not permitted.

Referring to Fig. 4.4:

1. Using a suitable screwdriver, release door retaining screw (A) and open the transmitter door.
2. Release cover plate retaining screw (B) and remove cover plate (C).
3. Slide retaining clip (D) off blanking plug (E) and remove the blanking plug.
4. Fit cable gland (F) and secure using nut (G).
5. Remove gland cover (H) and route mains power supply cable (J) through it.
6. Route the cable through cable gland (F) and into the enclosure case.

i IMPORTANT (NOTE) Cable glands are supplied with single- and twin-holed bushes. Use a single-holed bush for the mains power cable.

7. Make connections to the power supply connection terminals (K).
8. Tighten gland cover (H).
9. Refit cover plate (C) and secure it with retaining screw (B).
10. Close the transmitter door and secure with door retaining screw (A).

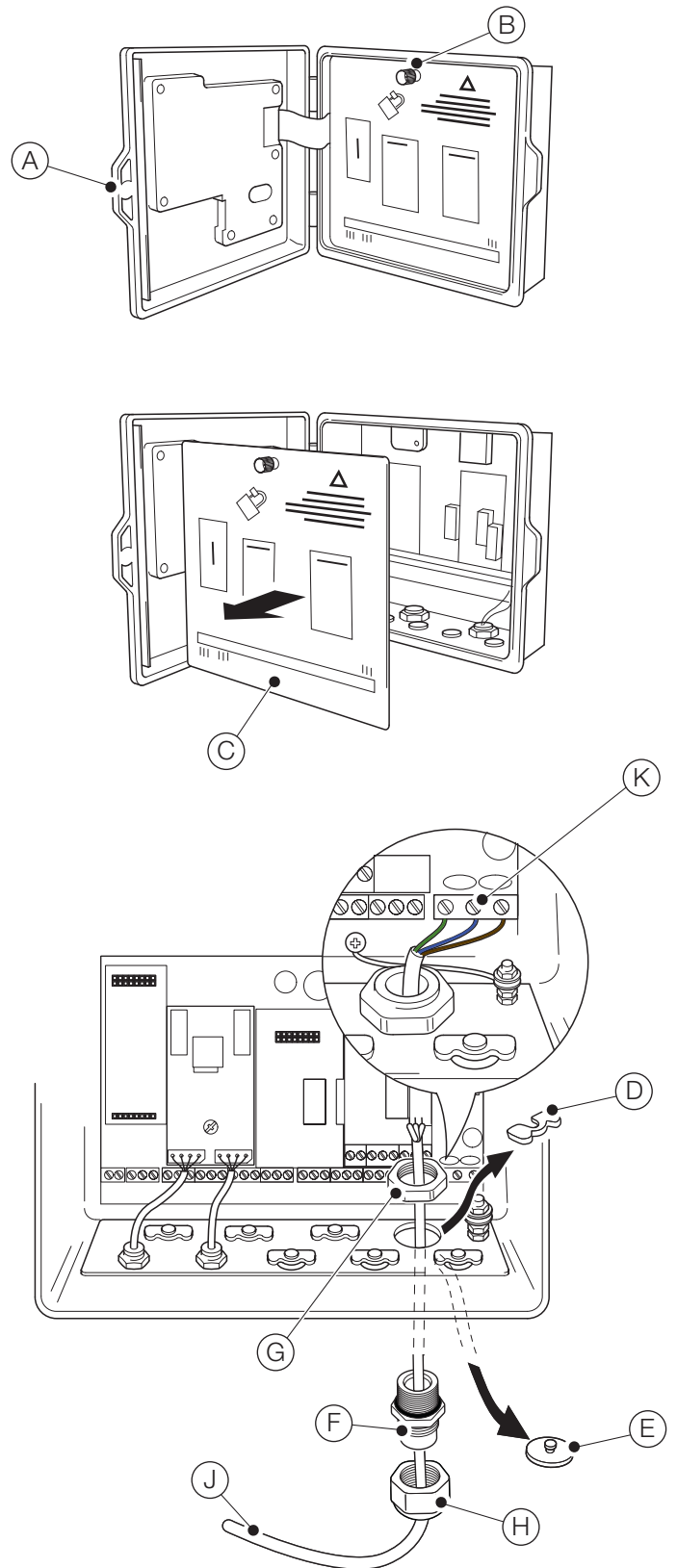

Fig. 4.4 Connecting the transmitter mains power supply

4.2 Sensor EZLink connection

i IMPORTANT (NOTE)

Maximum length of cable from transmitter to sensor(s) – refer to sensor Operating instruction.

The Aztec AWT440 transmitter is supplied as standard with 2 sensor EZLink connections.

Referring to Fig. 4.5:

1. Align the pins in sensor cable connector (A) with the holes in EZLink connector (B) and push the connectors together.
2. Turn nut (C) clockwise to secure the connectors together.

The transmitter detects the type of sensor connected automatically.

i IMPORTANT (NOTE)

A single Aztec AWT440 transmitter can monitor the inputs from up to 4 sensors. Each smart sensor interface module can accommodate 2 sensors. Therefore, to monitor 4 sensors, 2 input modules must be fitted to the transmitter.

i IMPORTANT (NOTE)

When installing sensor extension cables, ensure the male end (end with label) of the cable is installed towards the transmitter.

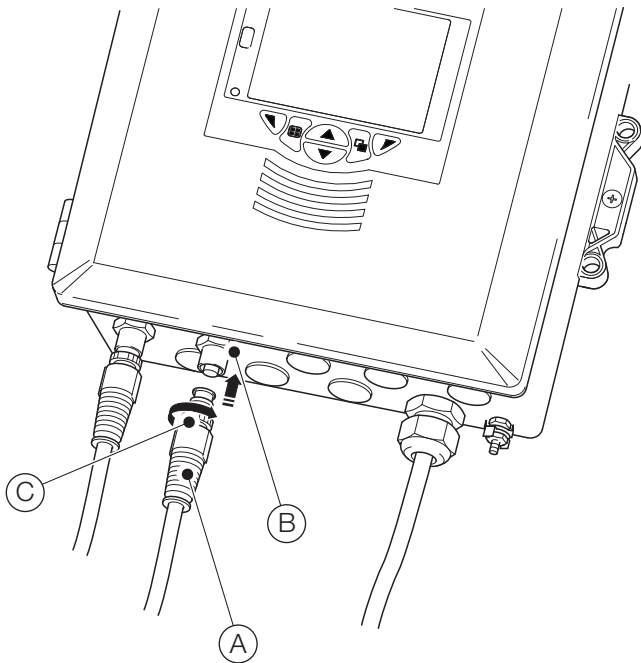
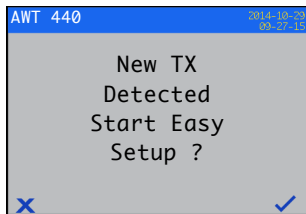





Fig. 4.5 Connecting the sensor EZLink connectors

5 Easy setup

When the transmitter is started up for the first time, or when **Restore defaults** is selected from the *Configuration/Device Setup/Initial Setup* menu (see Section 12.3, page 31), the 'Easy Setup' prompt is displayed:





Press the  key (**Select**) to start *Easy Setup* or press the  key (**Exit**) to cancel and exit to the main *Operator* page.

Press the  key (**Edit**) to change the default value / setting to the required value / selection. Press the  key (**Next**) to accept the default or revised value /selection and advance to the next parameter.

Transmitter parameters that can be configured in this way are: Language, Instrument Tag, Diagnostics View, Signals View, Chart View, Alarm View, Analog OP View, Calibration Log, Alarm Log, Audit Log, Diagnostics Log, Date Format and Date & Time.

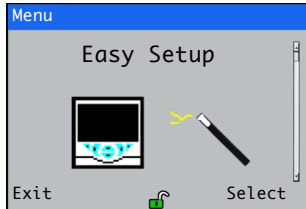
On completion of *Easy Setup*, the display returns to the 'Easy Setup' start screen:



Press the  key (**Select**) to revise / amend the settings just made or press the  key (**Exit**) to cancel and exit to the main *Operator* page.

All transmitter parameters can be revised / changed at any time by selecting *Enter Configuration* from any *Operator* or *View* page menu, followed by *Advanced* from the *Access Level* menu.

IMPORTANT (NOTE)

- If 'Easy Setup' does not detect a keypress within 5 minutes, the display changes automatically to the main *Operator* page.
 - Refer to Section 8.1, page 17, for details of menu navigation and parameter selection / adjustment.
-

6 Calibration and sensor setup

Calibration and sensor setup are sensor-specific – refer to the relevant sensor Operating instruction to perform a calibration and setup the sensor.



CAUTION – Minor injuries

Do not attempt to setup the transmitter unless the sensor and transmitter are fully installed and ready for operation.

Ensure all electrical connections have been made correctly and switch on the power to the transmitter. If the sensor is being commissioned for the first time, sensor calibration and set-up is recommended for best results.



IMPORTANT (NOTE)

- The menu structure, general operation and menu descriptions are detailed in Section 12, page 30.
 - Refer to Section 8.1, page 17, for details of menu navigation and parameter selection / adjustment.
-

7 'Hot-plugging'

Hot plugging is a feature of the AWT440 transmitter that enables sensors to be added, removed or replaced without the need to power down the transmitter. The EZLink connector enables sensors to be connected and disconnected without tools and without opening the transmitter enclosure. Hot plugging also enables a sensor to be configured in one location, then installed in a different location without the need to reconfigure the sensor as all the configuration values are stored in the sensor.

Hot-plugging recognizes both the connection of a replacement sensor to an input channel previously used by another sensor and the connection of a new sensor to a previously unused input channel.

The 'Easy Setup' menu is displayed when a new or replacement sensor is connected to the transmitter.

For the purposes of the remainder of Section 7, the following definitions apply:

Sensor setup parameters are those that are sensor-specific and are stored in the sensor (for example, sensor tag, serial number, cleaning interval, units, date of manufacture etc.). For some sensor types, the setup parameters may also include primary variable, measurement units and measurement range. The transmitter maintains a copy of these parameters as long as the sensor is connected.





Transmitter configuration parameters are those that define transmitter operation (for example, current output assignment and range, relay and alarm assignment). Some sensor types also store sensor setup parameters in the transmitter.

7.1 Sensor addition

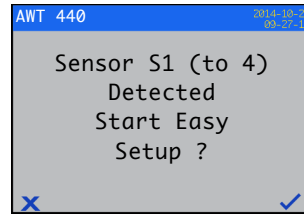

To add a new sensor to an unused input channel:

1. Connect the sensor to the transmitter EZLink connector – see Fig. 4.5, page 12. The transmitter detects the new sensor automatically and loads the **sensor setup parameters** stored in the sensor. When upload is complete, the 'Easy Setup' prompt is displayed:



2. Press the  key () to start Easy Setup or press the  key () to use the **sensor setup parameters** stored in the sensor.

i IMPORTANT (NOTE) The remaining steps are applicable only if Easy Setup is selected.

3. Press the  key (**Edit**) to change the default value / setting to the required value / selection. Press the  key (**Next**) to accept the default or revised value /selection and advance to the next parameter.

Sensor parameters that can be configured in this way are sensor-specific. Refer to the relevant sensor Operating instruction.

4. On completion of 'Easy Setup', the display returns to the 'Easy Setup' start screen:

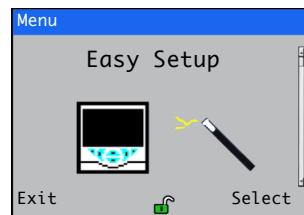

7.2 Sensor replacement

A sensor can be replaced by a sensor of the same type or a different type. If a sensor is replaced by one of the same type, the **sensor setup parameters** from the sensor being removed can be retained (see Section 7.2.1) for use with the new sensor, or set to use the values stored in the new sensor.

7.2.1 Replacing the sensor with a sensor of the same type

To replace a sensor of the same type and retain existing sensor setup parameters:

1. Disconnect the old sensor from the EZLink connector – see Fig. 4.5, page 12. The diagnostic message  **S1 (to 4):Removed** is displayed in the status bar at the bottom of the main *Operator* page.

IMPORTANT (NOTE)

To retain existing transmitter setup parameters for use with the new sensor:



do not acknowledge sensor removal after the  **S1 (to 4):Removed** warning is displayed. If sensor removal is acknowledged, the transmitter configuration for the channel is reset to factory defaults.

To maintain the value of analog, digital and relay outputs during sensor replacement, press the  key and select **Manual Hold** from the *Operator* page menu.

If a failure current has been configured for an analog output, the output's value is not held. Sensor removal is classed as a failure by the diagnostic system and this overrides the existing analog output current.

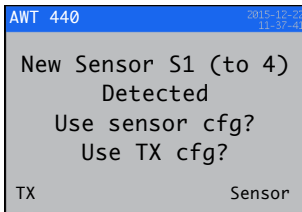



2. Connect the new sensor to the same EZLink connector – see Fig. 4.5, page 12. A user prompt is displayed offering a choice of which configuration to use:

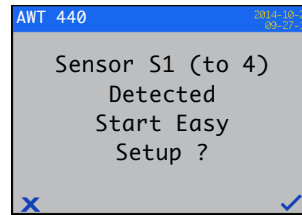

3. Press the  key (TX) to use the sensor configuration saved in the transmitter (used with the sensor previously connected) or press the  key (**Sensor**) to use the sensor configuration stored in the new sensor.



The 'Easy Setup' prompt is displayed:



4. Press the  key () to cancel Easy Setup and start measurement using the sensor immediately, or press the  key () to edit the sensor configuration using the Easy Setup menu – see Section 7.1, page 14, steps 2 to 4.

7.2.2 Replacing a sensor with a sensor of a different type

To replace a sensor with a sensor of a different type:

1. Disconnect the old sensor from the EZLink connector – see Fig. 4.5, page 12. The diagnostic message  **S1 (to 4):Removed** is displayed in the status bar at the bottom of the main *Operator* page.
2. Press the  key and select **Ack Sensor Removed** from the *Operator* page menu to reset the transmitter configuration parameters for this sensor to factory default values.
3. Connect and configure the new sensor as described in Section 7.1, page 14.

7.3 Sensor removal

When a sensor is disconnected, the diagnostic message

✘ S1 (to 4): **Removed** is displayed in the status bar at the bottom of the main *Operator* page.

To remove a sensor permanently, press the  key and select **Ack Sensor Removed** from the *Operator* page menu. This resets sensor setup parameters (stored in the transmitter) to factory defaults, clears all the output settings associated with the input (including analog output sources and alarm sources) and disables any associated digital output and relay sources. If more than one sensor remains connected, the *Operator* page display(s) for the remaining sensor(s) is (are) reset and any diagnostic messages related to the sensor that was removed are cleared. If no sensors are connected, the *Operator* page is blank.

To remove a sensor temporarily, **DO NOT** acknowledge sensor removal as described above. Sensor setup parameter settings for the input channel are retained. Analog and digital outputs continue to function as described in Section 7.4.

i **IMPORTANT (NOTE)** To maintain the value of analog, digital and relay outputs during temporary sensor removal, press the  key and select **Manual Hold** from the *Operator* page menu.

If a failure current has been configured for an analog output, the output's value is not held. Sensor removal is classed as a failure by the diagnostic system and this overrides the existing analog output current.

If a sensor is subsequently refitted, reconnection is detected by the transmitter and measurement using the sensor resumes. The diagnostic message is cleared and the state of any analog, digital and relay outputs are restored together with their associated alarm settings.

7.4 Device behavior on sensor removal

If a sensor is assigned as the source of an analog output and the sensor is disconnected from the transmitter, the analog output is driven to the configured failure current. If a failure current has not been configured, the analog output is driven to the minimum configurable output current.

If a sensor is assigned as the source of a low process alarm and the sensor is disconnected from the transmitter, the alarm is triggered. All digital outputs and relays assigned to the same alarm source are also set according to their configured polarity.

8 Operation

8.1 Front panel keys

The transmitter is operated using the keys on the front panel.

Prompts associated with active keys are displayed on each screen. *Diagnostic messages* are detailed in Appendix A.1, page 42, *display icon descriptions* are detailed in Section 11, page 28.

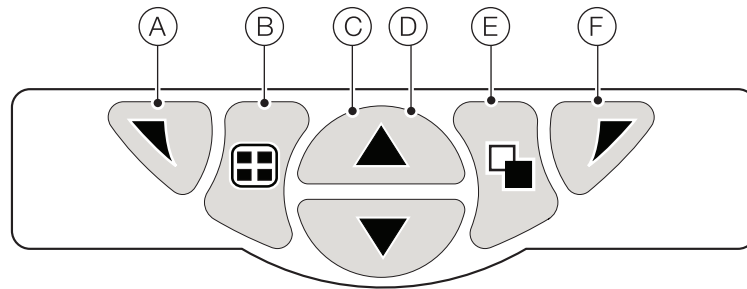

Fig. 8.1 Front panel keys







Key	Function	Description
(A) 	Navigation key – left and <i>Operator</i> menu access key	When any <i>Operating</i> , <i>View</i> or <i>Log</i> page is displayed, opens or closes the <i>Operator</i> menu and returns to the previous menu level.
(B) 	View key	Toggles the view between <i>Operator</i> pages, <i>View</i> screens and <i>Log</i> screens – see Fig. 8.2. Note. Disabled in Configuration mode.
(C) 	Up key	Used to navigate up menu lists, highlight menu items and increase displayed values.
(D) 	Down key	Used to navigate down menu lists, highlight menu items and decrease displayed values.
(E) 	Group key	Toggles between: <ul style="list-style-type: none"> – <i>Operator</i> pages (1 to 5) when an <i>Operator</i> page is selected with the <i>View</i> key. – <i>View</i> screens (<i>Diagnostics</i>, <i>Signals</i>, <i>Alarms</i>, and <i>Outputs</i>) when the <i>Diagnostic View</i> screen is selected with the <i>View</i> key. – <i>Log</i> screens (<i>Calibration</i>, <i>Alarm</i>, <i>Audit</i> and <i>Diagnostic</i>) when the <i>Calibration Logs</i> screen is selected with the <i>View</i> key. See Fig. 8.2. Note. Disabled in Configuration mode.
(F) 	Navigation key – right and <i>Cal</i> shortcut key	At menu level, selects the highlighted menu item, operation button or edits a selection. When any <i>Operating</i> , <i>View</i> or <i>Log</i> page is displayed, used as a shortcut key to access the <i>Calibrate</i> level.

Table 8.1 Key functions



i **IMPORTANT (NOTE)** The calibration log for a sensor (S1 to S4) is displayed only if that sensor is fitted.

Fig. 8.2 Menu navigation overview

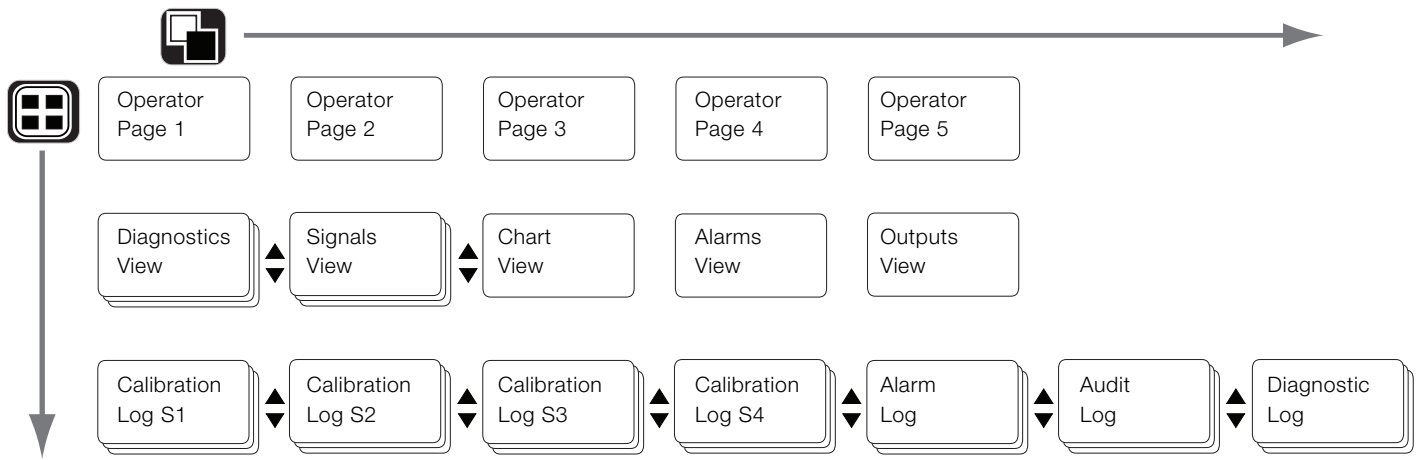
8.2 Operation modes

The transmitter has 4 modes of operation – all modes are accessed from the *Operator* menu – see Fig. 8.3:

- *Operating*: displays real-time sensor values on *Operating Pages* – refer to Section 8.4, page 20.
- *View*: displays diagnostic messages, alarms, output values, signals (including the flow rate where applicable) and (chart) traces – refer to Section 8.5, page 22.
- *Log*: displays recorded diagnostic, calibration and audit events and alarms – refer to Section 8.6, page 23.
- *Configuration*: enables the transmitter to be configured – refer to Section 12, page 30.

8.3 Operator menus

i IMPORTANT (NOTE)
Operator menus **cannot** be accessed directly from the *Configuration* level.

Referring to Fig. 8.3:

- *Operator* menus (A) are accessed from any *Operating*, *View* or *Log* page by pressing the ∇ key (B).
- *Operator* sub-menus (indicated by the \blacktriangleright arrow) are selected by pressing the ∇ key (C).
- The *Calibrate* page can be opened directly from an *Operator* page (bypassing the *Configuration* level menus) using *CAL* shortcut (D). Press the ∇ key (C) (below the *CAL* prompt).

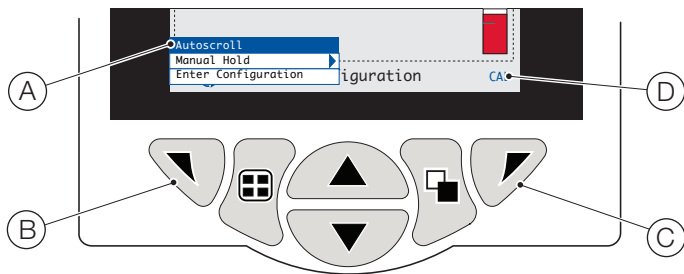

Fig. 8.3 Operator menus

Operator menus comprise:

- *Operator Pages*: displays the *Operator* page for each available sensor.
- *Data Views*: displays enabled data views.
- *Logs*: displays enabled *Log* views.
- *Alarm Acknowledge*: acknowledges the active alarm displayed in the *Alarms View*.
- *Manual Hold*: holds (freezes) the current outputs and alarms for the selected sensor(s).

i IMPORTANT (NOTE)
Active values are still indicated on the display.

- *Manual Clean*: initiates a sensor cleaning cycle.
- *Ack.Sensor Removed* (displayed only if a sensor is disconnected from the transmitter): confirms permanent sensor removal and resets transmitter configuration settings to factory default for the sensor input.
- *Media Card*: displays the status of the SD card / USB stick (enabled only if a removable media module is fitted) and enables the operator to place the media online / offline.
- *Autoscroll* (enabled on *Operator* pages only): displays *Operator* pages sequentially when multiple sensors are fitted.
- *Enter Configuration* (enabled on all pages): enters *Configuration* parameters via the *Access Level* – refer to Section 10.2, page 27 for access levels and password security options.

8.4 Operating mode

In operating mode, process values (PVs) from connected sensors are displayed on *Operator Pages*. A maximum of 5 *Operator Pages* can be displayed.

Operator Page 1 (the default page) displays the PVs from all connected sensors simultaneously (a maximum of 4 sensors can be connected). The remaining 4 *Operator pages* can be assigned to display values from individual sensors (in any sensor order). To achieve this, each sensor must be associated with a template in the *Configuration level / Display / Operator Templates* – see page 32.

In Fig. 8.4, *Operator page 1* shows that 4 sensors are connected.

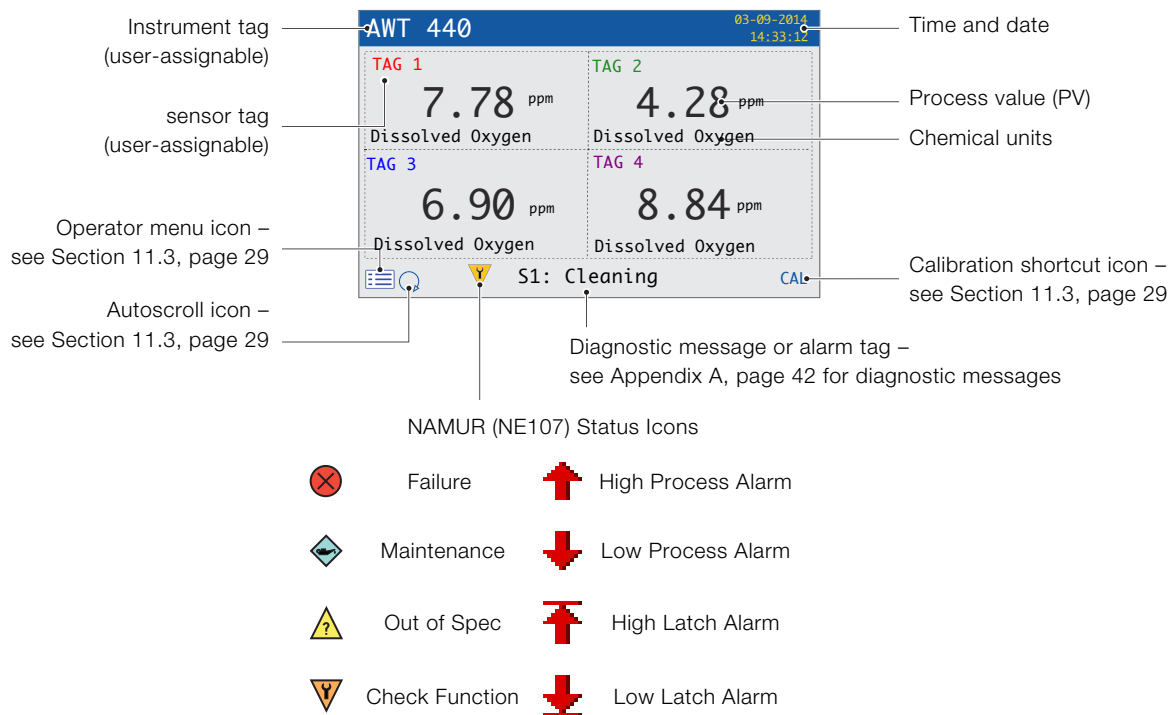

*The highest priority diagnostic or alarm is displayed. Other active diagnostic / alarm states can be viewed on the *Diagnostics View* – see page 22.

Fig. 8.4 Operator page 1 (optical dissolved oxygen multiple sensors)

Fig. 8.5 shows an overview of *Operator* pages 2 to 5. Each *Operator Page* displays the PV and temperature from a single sensor. Fixed, color-coded, user-assignable tags (one for each fitted sensor) and color-coded bargraphs aid identification of each sensor.

The bargraph indicates the PV. Minimum and maximum PVs are configurable in the *Sensor Setup* level. If the measured PV is above the maximum specified range of the sensor (refer to the sensor's Operating instruction), the bargraph flashes to indicate the value is outside the specified range.

When multiple sensors are fitted and *Autoscroll* is selected from the *Operator Menu* (see Fig. 8.3, page 19), the display scrolls through each available *Operator Page* consecutively.

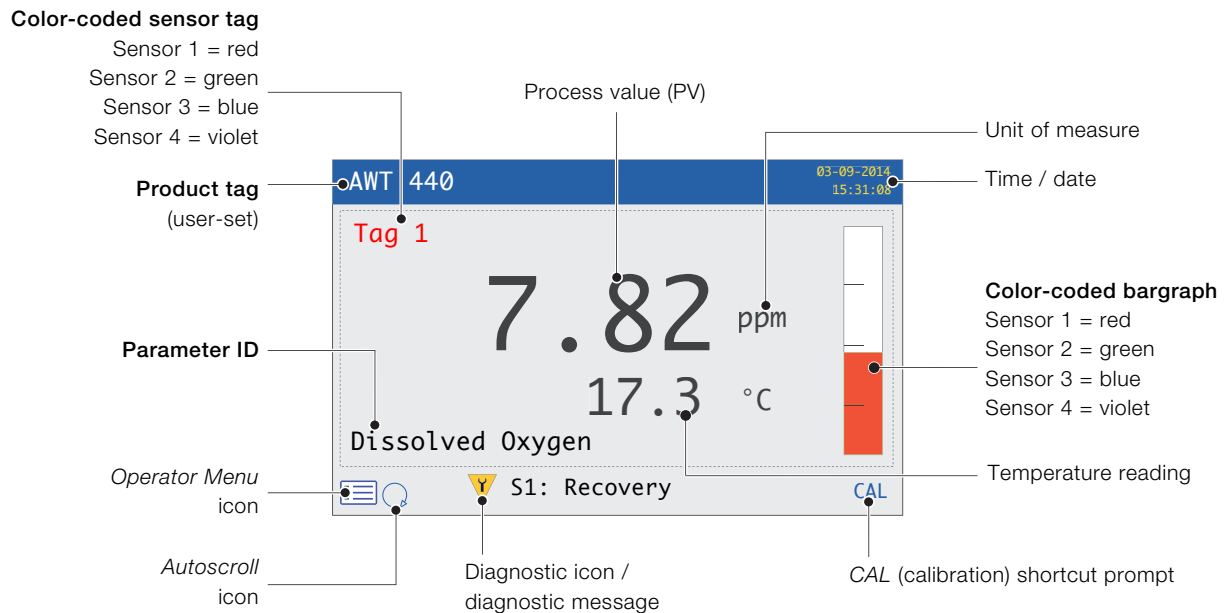

Fig. 8.5 *Operator* pages 2 to 5 – overview

8.5 View mode

Pages displayed in *View mode* comprise:

- *Diagnostics view* – displays a list of active diagnostic messages identified by priority and message – see Fig. 8.6
- *Signals view* – displays a list of active signals and their values – see Fig. 8.7
- *Chart view* – represents the sensor readings as a series of color-coded traces – see Fig. 8.8
- *Alarms view* – displays a list of alarms identified by priority (sequence number), source and status – see Fig. 8.9
- *Outputs view* – displays a list of alarms identified by analog output ID, output value and percentage of output value – see Fig. 8.10

NAMUR icon and message
priority – see page 42

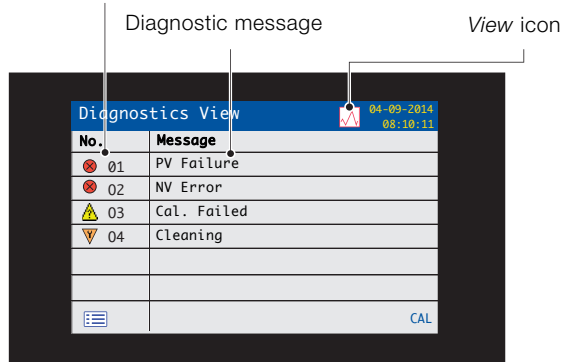

Fig. 8.6 Diagnostics view

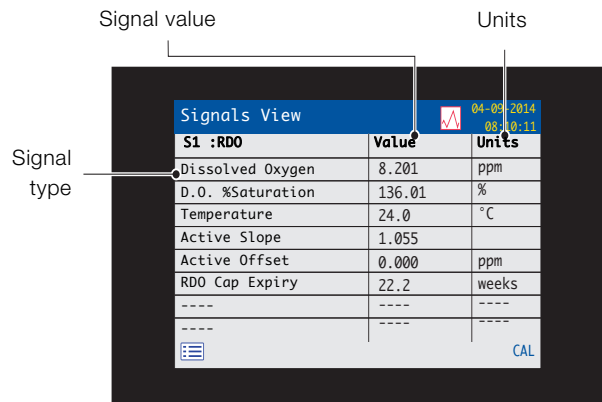

Fig. 8.7 Signals view

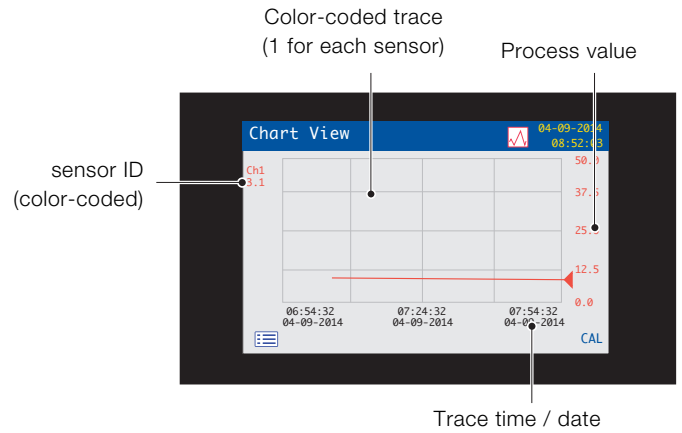

Fig. 8.8 Chart view

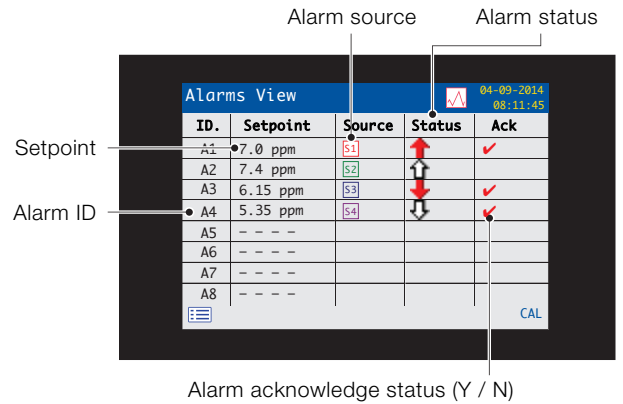

Fig. 8.9 Alarms view

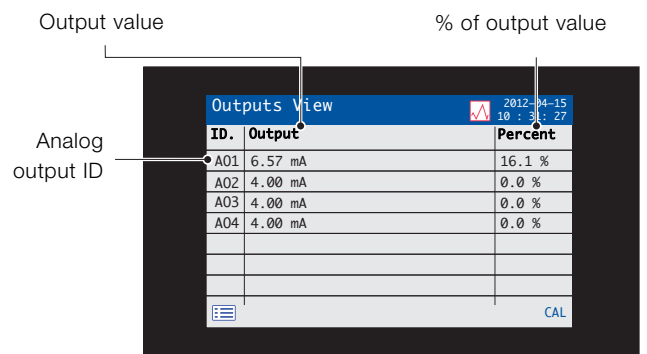

Fig. 8.10 Outputs view

8.6 Log mode

Log mode pages display logged information in the sequence it occurred.

Log mode pages comprise:

- *Calibration Logs*: a history of calibration routines. One log is provided for each sensor and is displayed only if the sensor is fitted. Each log can store 15 entries that are displayed in date order.
- *Alarm Log*: a history of alarm events.
- *Audit Log*: a history of analyzer activity.
- *Diagnostics Log*: a history of diagnostic events.

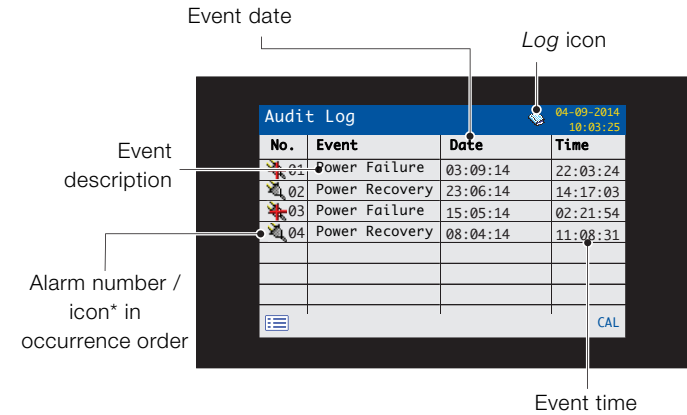

*Icons not displayed on *Alarm Log* or *Calibration Log*

Fig. 8.11 Log page (example of Audit Log shown)

8.6.1 Log entries

Example *Calibration Log* entries along with a description are shown in Table 8.2. Example *Audit Log* entries together with a description are shown in Table 8.3. The *Diagnostics Log* shows the history of diagnostic messages that have been displayed in the *Diagnostic View* – see Appendix A, page 42.

Log entry	Description
Cal Failed	Calibration procedure failed due to low slope or sample temperature error.
Cal Aborted	Calibration aborted manually by the user.
Cal Missed	Note. Applicable only to some sensors.

Table 8.2 Calibration log entries

Log entry	Description
Power Failure	Power to the transmitter is lost.
Power Recovery	Transmitter restarted after a power loss.
In Config.	User in <i>Advanced / Configuration</i> mode.
Time / Date Changed	User has changed date / time.
Daylight Saving	Time changed due to daylight saving.

Table 8.3 Audit log entries

9 Data logging

Data recorded in the transmitter's internal memory can be archived to a removable SD card or USB stick. The transmitter continuously records **all** data to its internal memory and keeps track of archived data.

i **IMPORTANT (NOTE)** ABB's DataManager Pro software can be used to store and view data archived from the transmitter.

The amount of time that data remains in the transmitter's internal memory depends on the sample rate – see Table 9.1.

Data is saved as text-format, comma-separated files. Configuration files are saved as binary-encoded files. Additional files can also be archived:

- Event log files containing *Audit Log*, *Alarm Log*, *Diagnostic Log* and *Calibration Log* data
- Data log files
- Configuration files

The transmitter's internal memory supports a maximum of 10 *Data Log* and *Event Log* files only and a maximum of 8 *Configuration* files. Durations for continuous recording are shown in Table 9.1 (internal storage).

5 s	10 s	30 s	1 m	5 / 10 / 30 m	1 hr
30 days	60 days	180 days	300 days	300 days	300 days

Table 9.1 Internal (flash) memory storage capacity

A 2 GB SD card / USB stick has sufficient external storage capacity for >5 years data.

9.1 Removable media



NOTICE – Property damage

To avoid potential damage or corruption to data recorded on removable media, take care when handling and storing. Do not expose to static electricity, electrical noise or magnetic fields. When handling an SD card / USB stick, take care not to touch any exposed metal contacts.

There are two methods of archiving to removable media:

– **An SD card / USB stick is kept in the transmitter**

Data is archived to the removable media automatically at set intervals. Archiving continues until the removable media is full; archiving then stops. To ensure all required data is archived successfully, swap the SD card / USB stick periodically for an empty one.

Back-up critical data stored on removable media regularly. The transmitter's internal memory provides a buffer for *the most recent data only*; if data stored on removable media is lost, it cannot be re-archived.

– **Data is copied to an SD card / USB stick when required**

When an SD card / USB stick is inserted into the transmitter, the media status can be set to *Online* causing unarchived data to be copied to the media – see Section 12, page 30 / *Media Card* menu level.

9.2 SD card / USB stick insertion and removal

i IMPORTANT (NOTE) The transmitter is supplied with either an SD card or USB stick reader; the appropriate media must be used with each system.

Referring to Fig. 9.1:

1. Using a suitable screwdriver, release door retaining screw (A).
2. Open the transmitter door and insert media (B). If required, press button (C) to place the media online. Red LED (D) is lit when the removable media is online.
3. To remove the media, if red LED (D) is lit, press button (C) to place the media offline and ensure LED is not lit.
4. Pull the removable media out of its socket. The media can then be inserted into an appropriate card reader / USB port on a PC and the data downloaded.
5. Close the transmitter door and secure with door retaining screw (A).

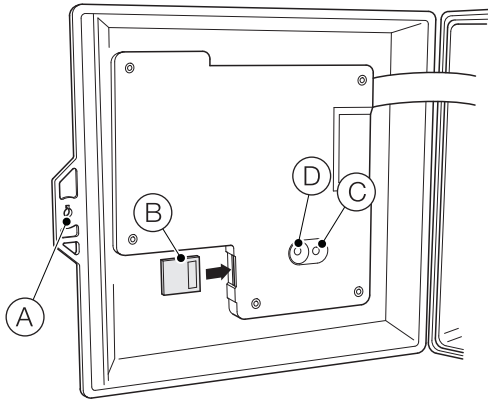

Fig. 9.1 SD card insertion and removal
(USB stick insertion / removal procedure is identical but not shown)

i IMPORTANT (NOTE) Data stored in the internal memory buffer can still be transferred to removable media when the archive media is placed on-line again (providing it is not off-line so long that the unarchived data in the internal memory is overwritten).

9.3 Archive file types

All files created by the transmitter are assigned filenames automatically. Each type of file is assigned a different file extension.

Archive files are created as text format, comma-separated data files.

The file type and extension for **Data** text files is '.D00'

— <ddmmmy><hhmmss><instrument tag>.D00

The file type and extension for **Event** log files (containing historical entries from the *Audit*, *Calibration*, *Diagnostic* and *Alarm* logs is '.A00'.

— <ddmmmy><hhmmss><instrument tag>.A00

i IMPORTANT (NOTE)

- The 'instrument tag' is set in the *Device Setup* level (see page 31) when the user has access at *Advanced* level – see Section 10, page 27.
- The time and date are formatted according to the format selected in the *Display* level (*Date & Time*) – see page 33.

The transmitter's internal clock can be configured to adjust automatically at the start and end of *Daylight Saving* periods – see page 33.

Configuration filenames are pre-set as *Config1* to *Config8*. The configuration file type and extension is '.CFG'.

9.4 Data files

Text format archived data is stored in a comma-separated value (CSV) format and can be imported directly into a standard spreadsheet, for example, Microsoft® Excel¹.

Alternatively, detailed graphical analysis of the data can be performed on a PC using ABB's DataManager Pro data analysis software.

New data files are created if:

- the transmitter configuration is changed.
- one of the current files exceeds the maximum permissible size (a new file is created at 00:00:00 a.m. on the following day). Data is logged into the existing file continuously until the new file is created.
- the daylight saving period starts or ends.
- working files cannot be found / are corrupted.
- the date and / or time is changed.

The filename is formatted as follows:

— Data logs: <ddmmmy><hhmmss><instrument tag>.D00

1. Microsoft and Excel are registered trademarks of Microsoft Corporation in the United States and/or other countries

9.5 Log files

The Alarm Event, Calibration, Diagnostic and Audit logs are archived into the same file. The filenames are formatted as follows:

- Event logs: <ddmmyy><hhmmss><instrument tag>.A00

9.6 Daylight saving

Files containing data generated during the daylight saving period have '~DS' appended to the filename.

Start of daylight saving period

A daily file is started at 00:00:00 on 30th March 2014 filename:

30Mar14_00_00_00_AWT 440.D00

Summertime starts at 2:00am on 30th March 2014 and the clock changes automatically to 3:00am.

The existing file is closed and a new file is created filename:

30Mar14_03_00_00_AWT 440~DS.D00

The file '30Mar14_00_00_00_AWT 440.D00' contains data generated from 00:00:00 to 01:59:59.

The file '30Mar14_03_00_00_AWT 440~DS.D00' contains data generated from 03:00:00.

End of daylight saving period

A daily file is started at 00:00:00 on 26th October 2014 filename:

26Oct14_00_00_00_AWT 440~DS.D00

Summertime ends at 3:00am on 26th October 2014 and the clock changes automatically to 2:00am.

The existing file is closed and a new file is created filename:

26Oct14_02_00_00_AWT 440.D00

The file '26Oct14_00_00_00_AWT 440~DS.D00' contains data generated from 00:00:00 to 02:59:59.

The file '26Oct14_02_00_00_AWT 440.D00' contains data generated from 02:00:00.



IMPORTANT (NOTE)

Daily files start at 00:00:00.

10 Password security and access level

Passwords are entered at the *Enter Password* screen accessed via the *Access Level* – see Section 10.2, below.

10.1 Setting passwords



Passwords can be set to enable secure access at 2 levels: *Calibrate* and *Advanced*. The *Service* level is password protected at the factory and reserved for factory use only.

Passwords can contain up to 6 characters and are set, changed or restored to their default settings at the *Device Setup / Security Setup* parameter – see page 31.

i IMPORTANT (NOTE) When the transmitter is powered-up for the first time, the *Calibrate* and *Advanced* levels can be accessed without password protection. Protected access to these levels can be allocated as required.

10.2 Access Level

The *Access Level* is entered via the *Operator* menu / *Enter Configuration* menu option – see Section 8.3, page 19.

Access levels – scroll to level using the  /  keys and press the  key (**Select**) to enter

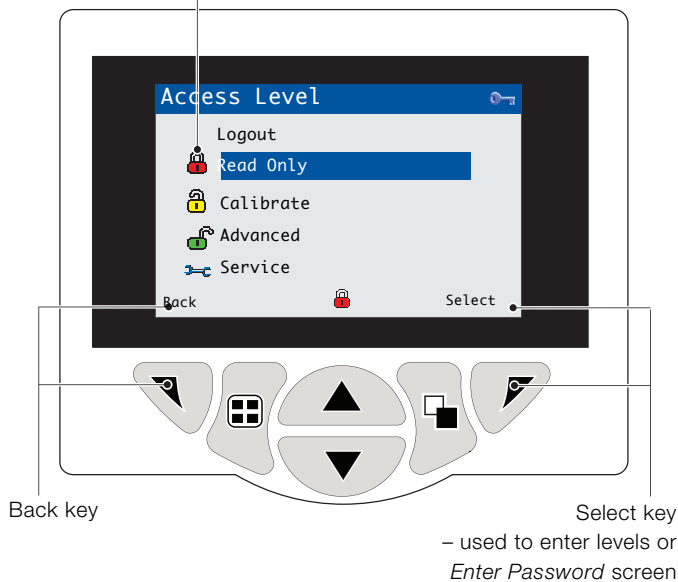
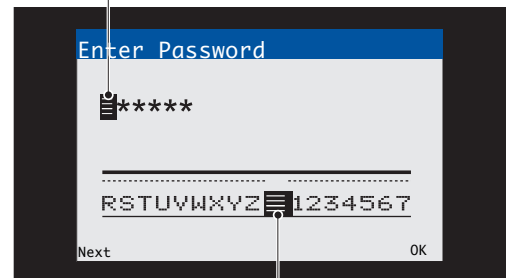

Fig. 10.1 Access level screen

Level	Access
Logout	Displayed only after <i>Calibrate</i> or <i>Advanced</i> levels are accessed. Logs the user out of the current level. If passwords are set, a password must be entered to access these levels again after selecting <i>Logout</i> .
Read Only	View all parameters in read-only mode.
Calibrate	Enables access and adjustment of <i>Calibrate</i> parameters. Calibration is sensor-specific – refer to the sensor Operating instruction for calibration details.
Advanced	Enables configuration access to all parameters.
Service level	Reserved for authorized service technicians only.

Table 10.1 Access level menu details

Cursor / Password character indicator
(maximum 6 characters)







Cursor – scroll characters using the  /  keys;
press  (**Next**) to accept character;
press  (**OK**) to accept password while last character is highlighted

Fig. 10.2 Enter password screen





11 Display icons

11.1 Diagnostic icons





i IMPORTANT (NOTE)

- When a diagnostic condition is detected, the associated NAMUR icon, plus the highest priority diagnostic message, is displayed in the Status Bar when the transmitter is in Operator View mode – refer to Appendix A, page 42 for diagnostic messages.
- If the status bar displays a diagnostic message, press the  key to see all diagnostic messages.















NAMUR icons

	Diagnostic icon – <i>Out of Specification.</i>
	Diagnostic icon – <i>Maintenance Required.</i>
	Diagnostic icon – <i>Failure.</i>
	Diagnostic icon – <i>Check Function.</i>

















Alarm, hold, clean and calibration icons

	Alarm – indicates a user-defined alarm condition (20-character) and flashes intermittently with an associated NAMUR diagnostic icon.
	Hold – indicates that alarms / analog outputs are in a manual hold state.
	Calibrating – indicates that a calibration is in progress.
	Cleaning – indicates that a manual or automatic clean is in progress.

















11.2 Title bar icons

	Log mode – indicates that one of the <i>View</i> pages is currently displayed (<i>Calibration, Alarm, Audit or Diagnostic</i>).
	View mode – indicates that one of the <i>View</i> pages is currently displayed (<i>Diagnostics, Alarms, Outputs, Signals or Chart</i>).
	Media on-line: 0 to <20 % full.
	Media on-line: 20 to <40 % full.
	Media on-line: 40 to <60 % full.
	Media on-line: 60 to <80 % full.
	Media on-line: 80 to <100 % full.
	Media on-line: full (icon toggles when full).
	Media off-line: 0 to <20 % full.
	Media off-line: 20 to <40 % full.
	Media off-line: 40 to <60 % full.
	Media off-line: 60 to <80 % full.
	Media off-line: 80 to <100 % full.
	Media off-line: not inserted (not logging).
	Media off-line: not inserted, logging active – icon display toggles with <i>Media off-line: not inserted (not logging)</i> icon.

11.3 Status bar icons

	Operator menu – displays the Operator menu when the  key is pressed.
	Autoscroll – indicates that <i>Operator</i> pages are displayed sequentially. Displayed only when <i>Autoscroll</i> enabled from the Operator menu. Disabled if 1 <i>Operator</i> page only is configured for display.
CAL	Calibration – shortcut access to the Calibration page when the  key is pressed.
	Enter – selects the highlighted option from the Operator menus when the  key is pressed.
	Service Level – indicates that alarms and analog outputs are held.
	Advanced Level – indicates that <i>Advanced Level</i> parameters are enabled for the current user.
	Calibrate Level – indicates that the <i>Calibration Level</i> parameters are enabled for the current user.
	Read Only Level – indicates that the transmitter is in <i>Read Only mode</i> . All parameters are locked and cannot be configured.
	Cleaning – indicates that a manual or automatic clean is in progress.
	In Hold Mode – indicates that alarms / analog outputs are in a manual hold state.
	High process alarm active / inactive.
	Low process alarm – active / inactive.
	High latch alarm – active / inactive.
	Low latch alarm – active / inactive.

11.4 Log icons

	Source: sensor 1 (red) S1 = sensor 1 process value. T1 = sensor 1 temperature.
	Source sensor 2 (green) S2 = sensor 2 process value. T2 = sensor 2 temperature.
	Source sensor 3 (blue) S3 = sensor 3 process value. T3 = sensor 3 temperature.
	Source sensor 4 (violet) S4 = sensor 3 process value. T4 = sensor 4 temperature.
	Power failed / power restored.
	Configuration changed.
	System Error.
	File created / deleted.
	Media inserted / removed.
	Media on-line / off-line.
	Media full.
	Date / time or daylight saving start / end changed.
	High process alarm active / inactive.
	Low process alarm – active / inactive.
	High latch alarm – active / inactive.
	Low latch alarm – active / inactive.
	Alarm acknowledged.

12 Configuration (Advanced access level)

Refer to Section 12.1, page 31

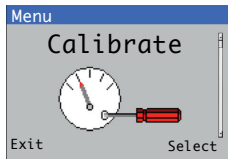

Calibration is sensor-specific. Refer to the relevant sensor operating instruction for details.

Refer to Section 12.2, page 31

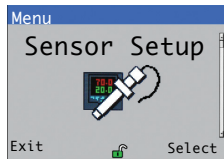

Sensor setup is sensor-specific. Refer to the relevant sensor operating instruction for details.

Refer to Section 12.3, page 31

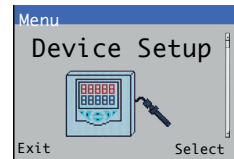

Initial Setup
Instrument Tag
Temperature Units
Restore Defaults
Security Setup
Calibrate Password
Advanced Password
Reset Passwords
Update Software

Refer to Section 12.4, page 32

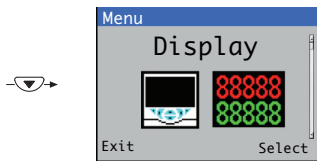

Language	View/Log Enables	Date & Time
Operator Templates Page 1 (to 5) Template	Diagnostic View Signals View Chart View Alarm View	Date Format Time & Date Daylight Saving DS Region
Chart View Channel S1 (to S4) Source Tag Chart Duration	Analog OP View Calibration Log Alarm Log Audit Log Diagnostics Log	DS Start Time DS End Time DS Start Occur DS End Occur DS Start Day DS End Day DS Start Month DS End Month
	Settings Brightness Contrast	

Refer to Section 12.5, page 34

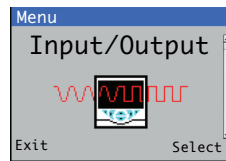

Analog Outputs Analog Output 1 (to 4) Source Output Type Elect. Low Elect. High Eng. Low Eng. High Output Failure Failure Current	Digital I/O Digital I/O 1 (to 6) Type Source Polarity Relays Relay 1 (to 6) Source Polarity
---	---

Refer to Section 12.6, page 36



Alarm 1 (to 8)
Source
Type
Tag
Trip
Hysteresis
Time Hysteresis

Refer to Section 12.7, page 37

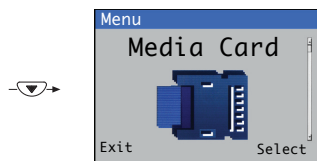

Data Logging
Logging Enable
Channel 1 (to 6)
Sampling Time
Save Configuration
Select File
Config1 (to 8)
Load Configuration
Select File
Config1 (to 8)
Format Card

Refer to Section 12.8, page 38

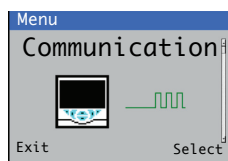

Communication level menus are displayed only if an optional communications module is fitted and depend on the type of module fitted. Refer to the supplementary communications manual (COM/AWT440-EN) for details.

Refer to Section 12.9, page 38

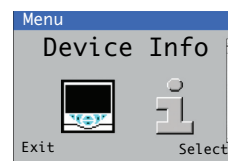

Transmitter Serial Number Date of manufacture Hardware Revision Software Revision Input/Output No. Analog Inputs No. Analog Outputs No. Relays Ethernet Ethernet Revision MAC Address Media Card Unit Software Version Hardware Version	Probe 1 (to 4) Type Serial Number Date of manufacture Hardware Revision Software Revision
--	---

Note. Service level menus (not shown) are password-protected at the factory and intended for use by authorized ABB service technicians only.

Fig. 12.1 Configuration (advanced access level) overview

12.1 Calibrate

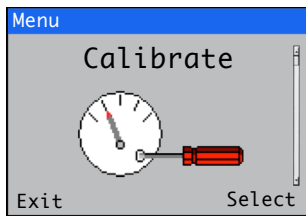

Used to calibrate the sensor.

Note. Calibration is sensor-specific. Refer to the relevant sensor manual for full details of sensor calibration.

Access to the *Calibrate* menu is permitted via the *Calibrate and Advanced* levels or directly from an *Operator* page using the *Cal* button.

12.2 Sensor setup

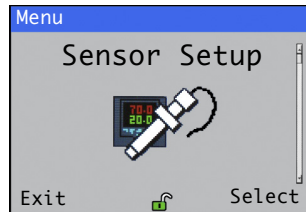

Used to set the sensor tag, measurement units, operational range, clean functions and other sensor-specific parameters.

Note. Sensor setup is sensor-specific. Refer to the relevant sensor manual for full details of sensor setup.

12.3 Device Setup

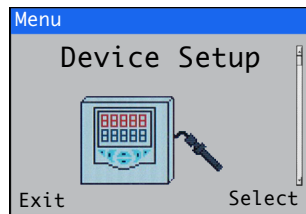

Used to access standard setup parameters.

Menu	Comment	Default
Initial Setup		
Instrument Tag	Enter an alphanumeric transmitter identification tag (16 characters maximum).	AWT 440
Temperature Units	Select the units in which all temperatures are displayed: °C / °F	°C
Restore Defaults	Select to restore <i>ALL</i> transmitter configuration parameters to their default values and restart the transmitter.	
Security Setup		
Calibrate Password	Set the password to enable access at <i>Calibrate</i> level.	Not factory-set
Advanced Password	Set the password to enable access at <i>Advanced</i> level.	Not factory-set
Reset Passwords	Clear all passwords.	
Update Software	Updates transmitter and / or sensor software (certain sensor types only) from a micro-SD card – see Appendix B, page 44.	

12.4 Display

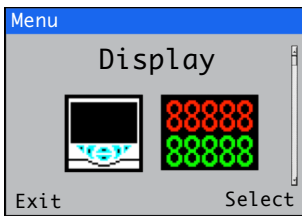

Used to select the display language, setup *Operator* page templates (1 to 5), enable diagnostic, view and log functions, set the device's display brightness / contrast and set the time and date.

Menu	Comment	Default
Language	Select the display language: <i>English / German / French / Italian / Spanish.</i>	English
Operator Templates		
Page 1 (to 5) Template	Assign a sensor to an <i>Operator</i> page template for display purposes – refer to Section 8.4, page 20 for <i>Operator Template</i> examples. Note. Page 1 template is assigned automatically to display all sensors currently connected (see Fig. 8.4, page 20) and cannot be changed.	
Chart View		
The chart can be configured to display the trend for 1, 2, 3 or 4 analog values. The engineering ranges for the process variable values are configured in the <i>Sensor Setup</i> menu – see page 31.		
Channel S1 (to S4)		
Source	Select the sensor signal to be displayed on the chart.	None
Tag	Enter an alphanumeric tag (3 characters maximum) to identify the sensor signal on the chart.	TAG1
Chart Duration	Select a chart duration: <i>1, 2, 4, 8, 12, 16, 20, 24 Hours</i>	1 Hour
View/Log Enables		
Select to enable / disable the following <i>Views and Logs</i> :		
Diagnostics View		Enable
Signals View		Enable
Chart View	Refer to Section 8.5, page 22 for examples of <i>Operator</i> pages in <i>View</i> mode.	Disable
Alarm View		Disable
Analog OP View		Disable
Calibration Log		
Alarm Log	Refer to Section 8.6, page 23 for examples of <i>Operator</i> pages in <i>Log</i> mode.	Disable
Audit Log		Disable
Diagnostics Log		Disable
Settings		
Select to set the following display parameters:		
Brightness	Press the ▲ / ▼ keys to increase / decrease the display's brightness in 10 % increments to suit local environmental conditions.	50%
Contrast	Press the ▲ / ▼ keys to increase / decrease the display's contrast in 10 % increments to suit local environmental conditions.	60%

Continued on next page...

Menu	Comment	Default
Date & Time	Select to set the transmitter's date, local time and daylight saving start / end times:	
Date Format	Select the date format required: <i>DD-MM-YYYY / MM-DD-YYYY / YYYY-MM-DD.</i>	YYYY-MM-DD
Date & Time	Set the date in the format selected at <i>Date Format</i> above and the time in the fixed format <i>HR:MINS:SEC</i> .	
Daylight Saving	Select to set the daylight saving parameters:	
DS Region	Select the geographical region to base the daylight saving hours on: <i>Off</i> – select to disable daylight saving. <i>Europe</i> – select to set European-standard daylight saving start and end times automatically. <i>USA</i> – select to set USA-standard daylight saving start and end times automatically. <i>Custom</i> – select to set daylight saving start and end times manually for regions other than Europe or USA. Note. The DS Start Time / Occur / Day / Month and Time menus (below) are displayed only when Custom is selected.	Off
DS Start Time	Set the daylight saving start time and end time in 1-hour increments.	1
DS End Time		2
DS Start Occur	Select the day within the month that daylight saving is to start / end.	Last
DS End Occur	For example, to set daylight saving to start (or end) on the second Sunday of the selected month, select <i>Second</i> .	Last
DS Start Day	Select the day of the month on which daylight saving is to start / end.	Sunday
DS End Day	Note. The <i>DS Start Occur / DS End Occur</i> parameters must be valid within the month for the selected day.	Sunday
DS Start Month	Select the month in which daylight saving is to start / end.	March
DS End Month		October

12.5 Input / Output

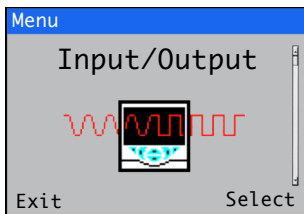

Used to enable configuration of analog outputs, digital inputs and outputs and relays.

Menu	Comment	Default
Analog Outputs	The analog outputs can be configured to retransmit the process variable and temperature values and have a configurable range from 0 to 22 mA.	
Analog Output 1 (to 4)	<i>Analog Outputs 3 and 4</i> are available only if an option board is fitted – see Fig. 4.1, page 9.	
Source	Select the sensor signal to be assigned to the output – see Section 12.10.1, page 39.	None
Output Type	The output characteristic is selectable dependent on sensor type.	Linear
Elec Low *	Set the minimum and maximum electrical range output values within the range 0.00 to 22.00 mA.	4.00 mA
Elec High *		20.00 mA
Eng Low *	Set the minimum and maximum engineering range output values within the range of measurement permitted by the sensor selected as the source.	Sensor specific
Eng High *		
Output Failure *	Select to enable / disable the output failure function. When enabled, the current output can be driven to a preset value if a <i>Failure</i> category diagnostic state occurs for the selected source – see page 42.	Enabled
Failure Current **	Set a value within the range 0 to 22 mA that the current output is driven to when a <i>Failure</i> category diagnostic state is present – see page 42.	22.0
* Displayed only if Source is NOT set to None		
** Displayed only if Output Failure is set to Enabled		
Digital I/O		
Digital I/O 1 (to 6)	See Fig. 4.1, page 9 for digital I/O connections.	
Type	Select the <i>Digital I/O</i> type: <i>Off</i> – no action taken. <i>Output</i> – the <i>Digital I/O</i> operates as an output. <i>Volt Free</i> – high input detected when volt-free switch across input is closed. <i>24 Volt</i> – digital input low <5 V, high >11 V (maximum input 30 V).	Off
Source	Select the digital signal to be assigned to the input / output – refer to Section 12.10, page 39.	None
Polarity	Sets the polarity of the input / output signal: <i>Inverted</i> – for an output, if the source is active the output is low. For an input, if a high signal is detected the input is inactive. <i>Non Inverted</i> – for an output, if source is active the output is high. For an input, if a low signal is detected the input is inactive.	Non Inverted

Continued on next page...

Menu	Comment	Default
Relays		
Relay 1 (to 6)	Relays 5 and 6 are available only if an option board is fitted – see Fig. 4.1, page 9.	
Source	Selects the digital signal to be assigned to the relay – refer to Section 12.10, page 39.	None
Polarity	Sets the polarity of the relay: <i>Non Inverted</i> (fail-safe) – if the source is inactive the relay is energized. <i>Inverted</i> (not fail-safe) – if the source is active the relay is energized.	Non Inverted

12.6 Process Alarm

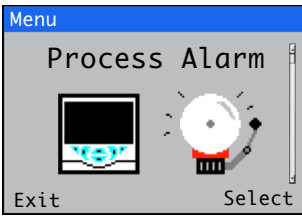

Used to configure up to 8 independent process alarms.

Menu	Comment	Default
Alarm 1 (to 8)		
Source	Select the sensor signal for the process alarm source.	None
Type	Select the alarm type: <i>High Process / Low Process / High Latch / Low Latch</i>	High Process
Tag	Enter an alphanumeric alarm identification tag (16 characters maximum). The <i>Tag</i> is displayed as a diagnostic message and appears in the <i>Diagnostic Status Bar</i> and on the <i>Diagnostic View</i> page at <i>Operator</i> level – see page 20.	Alarm 1 (to 8)
Trip	Set a trip value in engineering units.	0.00000
Hysteresis	Set a hysteresis trip value in engineering units. The alarm is activated at the alarm trip level but deactivated only when the process variable has moved into the safe region by an amount equal to the hysteresis value – see Process alarm examples below.	0.00000
Time Hysteresis	Set a time hysteresis trip value between 0.0000 and 9999.0 seconds. If the alarm trip value is exceeded, the alarm is not activated until the <i>Time Hysteresis</i> value has expired. If the signal goes out of the alarm condition before the <i>Time Hysteresis</i> has expired, the hysteresis timer is reset.	0.0000

Process alarm examples

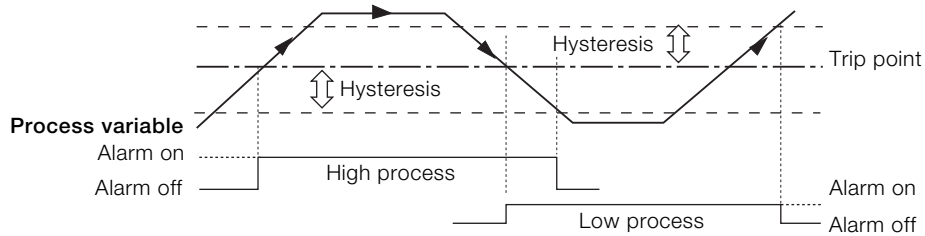

Fig. 12.2 High and low process alarm action

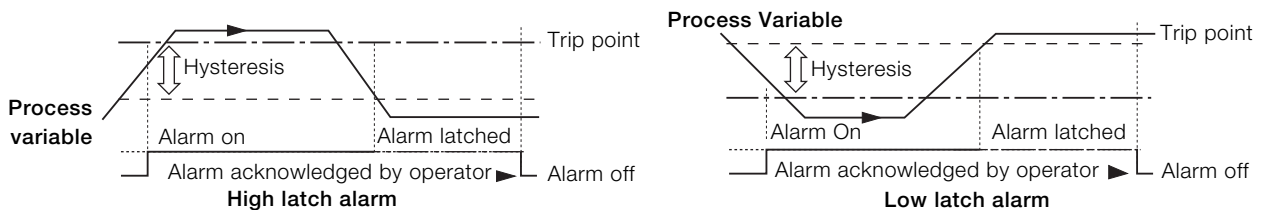
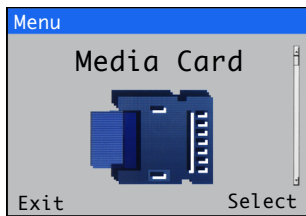

Fig. 12.3 High and low latch alarm action

12.7 Media Card



Used to enable / disable data logging, select the source of the data to be logged, save and load configuration files and to format external media.

Menu	Comment	Default
Data Logging		
Logging Enable	Select to enable or disable data logging. <i>Enable</i> – select to enable data to be written to internal / external media. <i>Disable</i> – select to prevent data from being written to internal / external media.	Enabled
Channel 1 (to 6)	Select the source of the data to be logged – refer to Section 12.10, page 39 for sources.	
Sampling Time	Select the sampling duration time: 5 / 10 / 30 Secs. 1 / 5 / 10 / 30 Mins. 1 Hr.	5 Secs.
Note. The following menu items are displayed only if an optional SD card / USB module is fitted and external media is inserted and has been placed online.		
Save Configuration		
Select File		
Config1 (to 8)	Select a position in which to create and save a configuration file containing user-defined sensor parameters to external media. Up to 8 files can be created. If a file exists in a position, it is displayed as Config1(Overwrite) . Either overwrite the existing file or select a new position in which to save it. Note. Wait until the progress bar is complete and the <i>OK</i> soft key prompt reappears before pressing the key. Pressing during a save operation cancels it prematurely resulting in an unusable configuration file.	
Load Configuration		
Select File		
Config1 (to 8)	Select a position from which to load a configuration file containing user-defined sensor parameters from external media. The most recently saved file is displayed. Press the key to display a list of other positions containing configuration files. Only positions containing configuration files are displayed.	
Format Card	Press the key (Yes) to format the SD card / USB stick if required. Note. Formatting erases all data currently on the SD card / USB stick.	

12.8 Communication

Optional MODBUS, Profibus or Ethernet communications modules are available for the Aztec AWT440 transmitter.

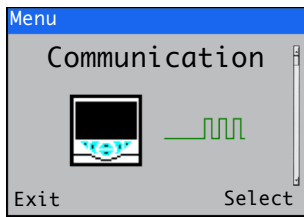

Communication level menus are enabled only if an optional communications module is fitted.

Refer to the communications supplementary manual (COM/AWT440-EN) for full details of Profibus, MODBUS and Ethernet connections and configuration together with tables detailing Profibus slot / indexes and MODBUS coils and registers.

12.9 Device Info

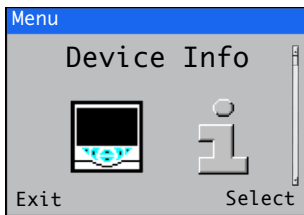

Displays read-only factory-set details for the transmitter and connected sensor(s).

Menu	Comment	Default
Transmitter		
Serial Number	The transmitter's serial number.	
Date of Manufacture	The transmitter's date of manufacture.	
Hardware Revision	The transmitter's hardware version number.	
Software Revision	The transmitter's software version number.	
Input/Output		
No. Analog Outputs	The number of analog outputs available.	
No. Relays	The number of relays available.	
Media Card Unit		
Software Version	The external media module's software version number.	
Hardware Version	The external media module's hardware version number.	
Ethernet		
Displayed only if an Ethernet communications module is fitted – see Fig. 4.1, page 9.		
Ethernet Revision	The Ethernet module's software version.	
MAC Address	The Ethernet module's physical address.	
S1 (to S4)		
Type	The type of sensor connected.	
Serial Number	The serial number of the sensor.	
Cap Serial Number	Note. Displayed only if an optical dissolved oxygen sensor is connected. The serial number of the cap fitted to the sensor.	
Date of Manufacture	The date of manufacture of the sensor.	
Hardware Revision	The hardware version number of the sensor.	
Software Revision	The software version number of the sensor.	

12.10 Analog sources and digital input / output sources

12.10.1 Analog sources

Source name*	Description
S1 (to 4)	Measured concentration value for the associated sensor.
Temperature 1 (to 4)	Measured temperature value for the associated sensor.

12.10.2 Digital output sources

Source name*	Description
Alarm 1 (to 8) State	Process alarm state (alarm 1 to 8).
S1 (to 4) Failure	The associated sensor is in the failed state – see Appendix A, page 42 for possible causes.
S1 (to 4) Out of Spec.	The associated sensor is out of specification – see Appendix A, page 42 for possible causes.
S1 (to 4) Maintenance	The associated sensor requires maintenance – see Appendix A, page 42 for possible causes.
S1 (to 4) Function Check	The associated sensor requires checking – see Appendix A, page 42 for possible causes.
Tx Failure	The transmitter is in the failed state – see Appendix A, page 42 for possible causes.
Tx Out of Spec.	The transmitter is out of specification – see Appendix A, page 42 for possible causes.
Tx Maintenance	The transmitter requires maintenance – see Appendix A, page 42 for possible causes.
Tx Function Check	The transmitter requires checking – see Appendix A, page 42 for possible causes.
S1 (to 4) Cal in Progress	A calibration is in progress for the associated sensor.
S1 (to 4) Cal Failed	The last calibration has failed for the associated sensor.
S1 (to 4) Clean	A clean is in progress for the associated sensor.

12.10.3 Digital input sources

Source name*	Description
S1 (to 4) Hold	The measured concentration for the associated sensor can be held via the digital input.
S1 (to 4) Clean Sequence	Note. Applicable only to some sensor types. Initiates an automated cleaning sequence.

Note. It is recommended that a momentary switch is used to start or abort digital input operations and a toggle switch is used for the hold functionality.

To start a digital input operation – hold the momentary switch for a minimum of two seconds; release the switch when the digital input operation starts.

To abort a digital input operation – hold the momentary switch for a minimum of two seconds; release the switch when the digital input operation aborts.

*(4) = maximum number of sensors if multiple sensors are connected.

13 Specification – transmitter

Operation

Display

89 mm (3.5 in.) color 1/4 VGA TFT, liquid crystal display (LCD) with built-in backlight and brightness / contrast adjustment

Language

English, German, French, Italian, Spanish

Keypad

6 tactile membrane keys:

Group select / left cursor, view select / right cursor, menu key, up, down, enter key

No. of inputs

Up to 4 sensors

Mechanical data

Protection

IP66 / NEMA 4X

Dimensions

Height – 194 mm (7.64 in.) minimum (excluding glands)

Width – 214 mm (8.42 in.) door closed – minimum

Depth – 98 mm (3.85 in.) door closed – minimum (excluding fixing brackets)

Weight – 1.5 kg (3.3 lb)

Panel dimensions

Cut-out height – 186 +1.1 –0 mm (7.32 +0.04 –0 in.)

Cut-out width – 186 +1.1 –0 mm (7.32 +0.04 –0 in.)

Thickness – 6 mm (0.236 in.) maximum

Distance between cut-outs – 40 mm (1.57 in.) minimum

Materials of construction

Glass-filled polycarbonate

Security

Password protection

Calibrate and Advanced – user-assigned

Service level access – factory-set

Electrical

Power supply ranges

100 to 240 V AC $\pm 10\%$, 50 / 60 Hz

(90 min. to 264 V max. AC, 45/65 Hz)

Optional

24 V DC

(18 min. to 36 V max. DC)

Power consumption

<30W

Terminal connections rating

AWG 26 to 16 (0.14 to 1.5 mm²)

Analog outputs

2 standard

2 optional

Galvanically isolated from the rest of the circuitry, 500 V for 1 minute.

Range-programmable source and range 0 to 22 mA, maximum

load 750 Ω @ 20 mA

Relay outputs

4 standard

2 optional

Fully-programmable. Contacts rated at 2A @ 110 / 240 V.

Standard relays are changeover.

Optional relays are normally closed (NC).

Digital inputs / outputs

6 standard, user-programmable as input or output

Minimum input pulse duration: 125 ms

Input – volt-free or 24 V DC (conforms to IEC 61131-2)

Output – open-collector, 30 V, 100 mA max.

(conforms to IEC 61131-2)

Connectivity / communications (optional)

Ethernet

TCP/IP, HTTP

Profibus

DPV1

MODBUS

RTU RS485

Data logging

Storage

Measurement value storage (programmable sample rate)

Audit log*, Alarms log*, Calibration log, Diagnostics log

Chart view

On local display

Historical review

Of data

Data transfer

SD card interface / USB stick – Windows-compatible FAT file system, data and log files in Excel and DataManager Pro compatible formats

**Audit log* and *Alarm log* data are stored in the same log file.

Environmental data

Ambient operating temperature:

–10 to 55 °C (14 to 131 °F)

Ambient operating humidity:

Up to 95 % RH non-condensing

Storage temperature:

–20 to 85 °C (–4 to 185 °F)

Approvals, certification and safety

Safety approval

cULus

CE mark

Covers EMC & LV Directives

(including latest version EN 61010)

General safety

EN61010-1

Pollution degree 2

Insulation class 1

EMC

Emissions & immunity

Meets requirements of IEC61326 for an industrial environment and domestic emissions

DS/AWT440-EN Rev. A

Appendix A – Troubleshooting

A.1 Diagnostic messages

The transmitter is programmed to display diagnostic messages to provide information on servicing requirements and any other conditions that develop during operation.

All diagnostic messages displayed on the transmitter are added to the transmitter's *Audit Log*.

The following tables show icon types, diagnostic messages and possible causes / suggested remedial action.





Diagnostic Icon	NAMUR Status
	Failure
	Check function
	Out of specification
	Maintenance required

Table A.1 NAMUR diagnostic icons



IMPORTANT (NOTE)

- The diagnostic icons in Table A.1 conform to NAMUR 107.
- For sensor-specific diagnostics messages, refer to the sensor manual.







Icon	Diagnostic message	Possible cause and suggested action
	ADC Failure (S1, S2, S3, S4)	Sensor failure (temporary or permanent failure of analog to digital converter for sensor 1, 2, 3, 4). Cycle power to the transmitter. If problem persists, replace electronics inside sensor. If problem still persists contact local service organization.
	Excessive Power	The sensor is drawing more current than available. The power being drawn from the transmitter exceeds the maximum permitted level. Check the wiring to all sensors connected for possible wiring problems. Check any digital outputs powered from the +24 V out terminal.
	Int Comms Error	Communication to sensor failure. Communication to one or all the sensors has failed during cyclic reads. Check wiring between transmitter and sensors.
	NV Error Comm Bd	NV error – comms. board (CRC Comms.). Failure of non-volatile memory on communications board or permanent corruption of its data. Cycle power to the transmitter. If problem persists, check all configuration parameters and correct any errors. If problem still persists, contact local service organization.
	NV Error Main Bd	NV error – main board (CRC Comms.). Failure of non-volatile memory on main board or permanent corruption of its data. Cycle power to the transmitter. If problem persists, check all configuration parameters and correct any errors. If problem still persists, contact local service organization.
	NV Error Proc Bd	NV error – processor board (CRC Comms.). Failure of non-volatile memory on processor/display board or permanent corruption of its data. Cycle power to the transmitter. If problem persists, check all configuration parameters and correct any errors. If problem still persists, contact local service organization
	NV Error (S1, S2, S3, S4)	Failure of sensor (1, 2, 3, 4) non-volatile memory or permanent corruption of its data. Cycle power to the transmitter. If problem persists, check all configuration parameters for all sensors and correct any errors. If problem still persists, contact local service organization.

Table A.2 Diagnostic messages (Sheet 1 of 2)

















Icon	Diagnostic message	Possible cause and suggested action
	NV Error SW Key 1	NV error – software key 1 (CRC Comms.). Failure of non-volatile memory on software key 1 board or permanent corruption of its data. Cycle power to the transmitter. If problem persists, check all configuration parameters and correct any errors. If problem still persists, contact local service organization.
	Temp Failure (S1, S2, S3, S4)	Temperature sensor failure for sensor 1 (2, 3, 4). The temperature compensator or associated connections are either open-circuit or short-circuit. Check wiring at temperature compensator connections to the PCB.
	PV Failure (S1, S2, S3, S4)	Process variable / sensor failure for sensor 1 (2, 3, 4). Temporary or permanent failure of operation of sensor. Cycle power to the transmitter. If problem persists, replace sensor cap or complete probe assembly. If problem still persists, contact local service organization.
	S1 (to 4): Removed	The transmitter has detected that a sensor has been disconnected. Measurement stops until the sensor is reconnected. Intentional sensor disconnection can be acknowledged by selecting <i>Ack. Sensor Removed</i> in the <i>Operator</i> page menu.
	Calibrating (S1, S2, S3, S4)	Displayed during calibration of sensor 1 (2, 3, 4). On a multiple sensor setup, this inhibits the calibration of other sensors.
	Cleaning (S1, S2, S3, S4)	Indicates that a manual or automatic sensor clean cycle is in progress.
	In Hold Mode (S1, S2, S3, S4)	Sensor (1, 2, 3, 4) in manual hold mode via front panel. Analog outputs and alarms are held. To exit manual hold press the  key, scroll to <i>Manual Hold</i> and select the appropriate sensor(s).
	Recovery (S1, S2, S3, S4)	The time delay between the completion of a sensor clean cycle and the display of a new reading on the <i>Operator</i> page.
	Simulation On	The analyzer is operating in <i>Simulation</i> mode.
	Cal. Failed (S1, S2, S3, S4)	Last sensor calibration failed. Calibration is sensor-specific – refer to the sensor Operating instruction.
	Media Card Full	Memory card is full, no more data can be saved to the card. Replace memory card.
	Missed Cal. (S1, S2, S3, S4)	Missed last schedule calibration. Note. Applicable only to sensor types with automatic calibration facility.
	PV Range (S1, S2, S3, S4)	Process value (PV) measured is outside the specified range of the sensor.
	Temp Range (S1, S2, S3, S4)	Sample solution temperature is above or below the temperature range of the sensor.
	Media Near Full	Memory card is more than 90% full. Replace memory card.

Table A.2 Diagnostic messages (Sheet 2 of 2)

Appendix B – Upgrading / reloading system software



DANGER – Serious damage to health / risk to life

Isolate the transmitter from the power supply before removing the terminal cover.



NOTICE – Property damage Transmitter boards and modules are vulnerable to electrostatic damage. Wear an anti-static strap at all times during these procedures.

The software upgrade process is used to upgrade both the transmitter's software and the software used in certain types of sensor when they are connected to the transmitter – refer to Section B.1 to upgrade the software.

Reloading the current software version may be necessary if, for example, the current version of software in the transmitter or sensor is corrupt – refer to Section B.2, page 46 to reload the software.

The software upgrade file is available for download from the ABB Library and must be unzipped and copied to a micro-SD card.





IMPORTANT (NOTE) Use only micro-SD cards of type SC or HC with a capacity not exceeding 32 GB, partitioned as FAT16 / FAT32.

B.1 Upgrading system software

To upgrade transmitter / sensor software:

1. Isolate the transmitter from the power supply.
2. Referring to Fig. B.1:
 - a. Using a suitable screwdriver, release door retaining screw (A) and open the transmitter door.
 - b. Release cover plate retaining screw (B) and remove cover plate (C).
 - c. Insert micro-SD card (D) containing the system software into card reader (E) on smart interface module (F). Press fully home and ensure the card clicks into place.
 - d. Close the transmitter door and secure with door retaining screw (A).

3. Restore the transmitter's power supply and allow the transmitter to start up.
4. Press the  key and select **Enter Configuration** from the operator menu.
5. Select *Advanced* from the *Access Level* screen and use the  and  keys to scroll to the *Device Setup* screen.

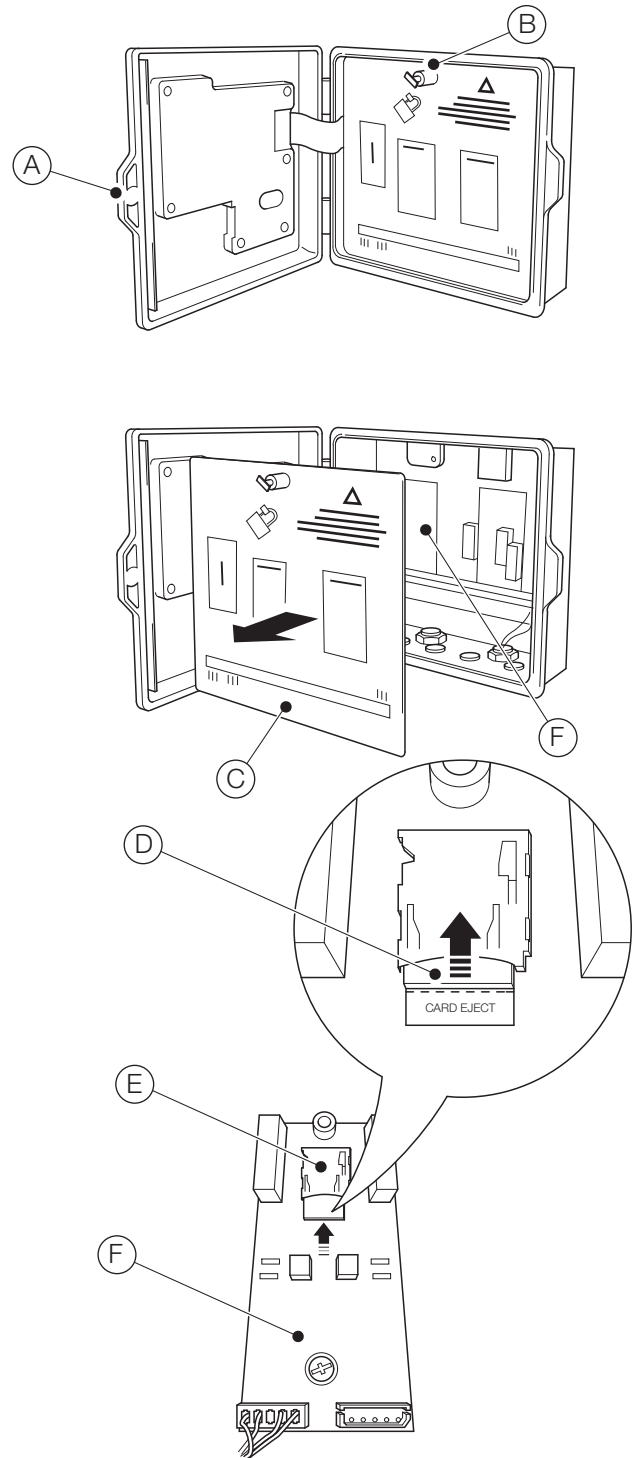
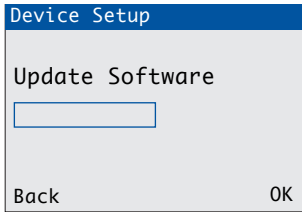
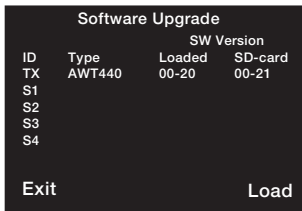

Fig. B.1 Inserting micro-SD card

6. Press the key (**Select**) and use the and keys to highlight *Update Software* and press the key (**Select**). The *Update Software* screen is displayed:



7. Press the key (**OK**). The *Software Upgrade* screen is displayed:



- ID** 'TX' indicates transmitter software. S1 to S4 indicates sensor software (applicable only to sensors that are designed to have their on-board software upgraded while connected to the transmitter)
- Type** The transmitter and / or sensor type
- Loaded** The version of software currently loaded in the transmitter and / or sensor(s)
- SD-card** The version of software on the micro-SD card that can be loaded to the transmitter and / or sensor(s)

i IMPORTANT (NOTE) Step 8 is applicable only if the *Software Upgrade* screen indicates that the micro-SD card contains software for more than one device (for example, transmitter + S1).

8. Press the key (**Load**) and use the and keys to highlight the required software.

i IMPORTANT (NOTE) If the version of software currently loaded in the transmitter is the same as that on the micro-SD card and the key (**Load**) is pressed, the software is not loaded. The **Load** soft key is replaced by the **Refresh** soft key. Pressing the key (**Refresh**) refreshes the information displayed on the *Software Upgrade* screen (see step 7).

9. Press the key (**Load**) to start the software upgrade process. The upgrade process verifies the file on the micro-SD card:

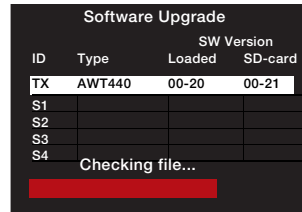

... erases the existing software in the transmitter:

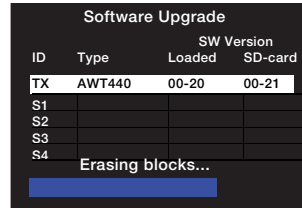

... and writes the new software to the transmitter:

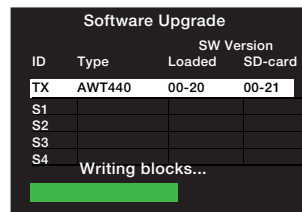

When the green progress bar has completed, the *Software Upgrade* screen is displayed:

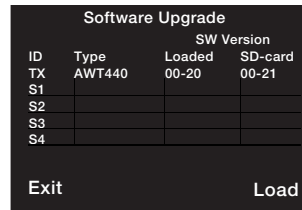

10. Press the key (**Exit**). The *Upgrade Complete* screen is displayed:

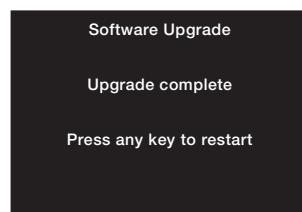

11. To retain transmitter configuration settings, **DO NOT** press a key – isolate the transmitter from the power supply.

i IMPORTANT (NOTE) If a key is pressed, the transmitter restarts but diagnostic messages associated with the software upgrade are displayed. The messages are cleared by selecting *Restore Defaults* from the *Device Setup* menu but this resets all transmitter configuration settings to factory default.



12. Referring to Fig. B.1:

- a. Using a suitable screwdriver, release door retaining screw (A) and open the transmitter door.
- b. Press micro-SD card (D) fully into card reader (E) on I/O module (F) to unlock the card and extract it from the card reader.
- c. Refit cover plate (C) and secure with screw (B).
- d. Close the transmitter door and secure with door retaining screw (A).





13. Restore the transmitter's power supply.

B.2 Reloading system software

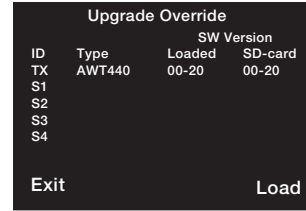
To reload the software in either the transmitter or a sensor attached to the transmitter:

1. Refer to Section B.1 and perform steps 1 to 8.
2. Press the  and  keys simultaneously. The top line of the *Software Upgrade* screen changes to *Upgrade Override*:



3. Press the  key (**Load**) and (if necessary) use the  and  keys to highlight the required software.
4. Press the  key (**Load**) and complete the software upgrade process – refer to Section B.1, steps 9 to 13.

B.3 Fault diagnosis

Possible error	Possible cause	Suggested action
SD card init failed	Micro-SD card not inserted or not inserted fully.	Insert card until it clicks and is retained in place.
	Software upgrade file not present on micro-SD card.	Obtain software upgrade file from the ABB Library and copy to micro-SD card.
Application invalid	Checksum incorrect due to corrupted file.	Obtain new copy of software upgrade file from the ABB Library and copy to micro-SD card
FS mount failed	No valid partition (FAT16 / FAT32) on micro-SD card or micro-SD card has no or invalid format.	Repartition and / or reformat the micro-SD card and recopy the software upgrade file onto the card.
Transmitter powers down during upgrade process.	Power failure.	Restore power to the transmitter. The transmitter enters software upgrade mode automatically if the current transmitter software has been corrupted. Restart the software upgrade process – see Section B.1, page 44.

Appendix C – Spare parts

C.1 EZLink sensor extension cables

Part No.	Description
	EZLink extension cable assembly:
AWT4009010	1 m (3.3 ft.)
AWT4009050	5 m (16.4 ft.)
AWT4009100	10 m (32.8 ft.)
AWT4009150	15 m (49.2 ft.)
AWT4009250	25 m (82.0 ft.)
AWT4009500	50 m (164.0 ft.)
AWT4009000	100 m (328.0 ft.)

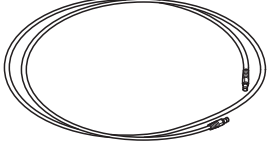



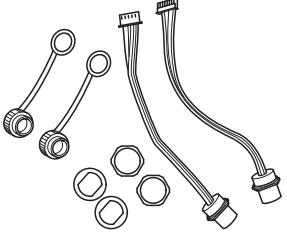
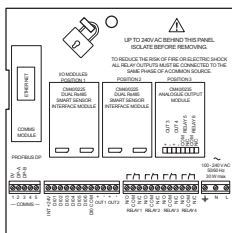
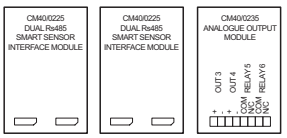
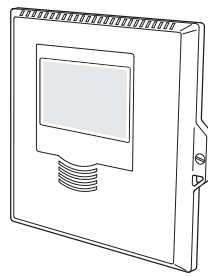

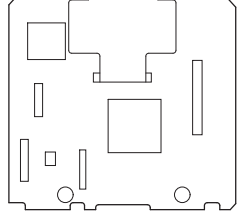
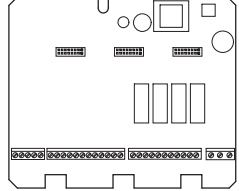
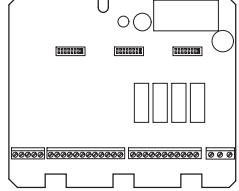
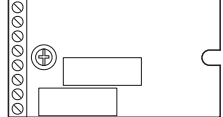
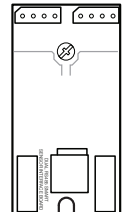
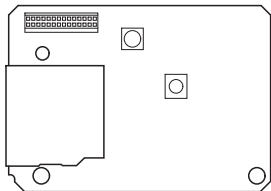
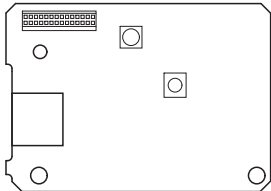
C.2 Aztec AWT440 transmitter spares

Part No.	Description
AWT440707	AWT440 transmitter bulkhead connector (120 mm) kit
	
AWT440708	AWT440 terminal cover plate
	
AWT440709	AWT440 option board labels
	
AWT440710	AWT440 door assembly (ABB) spares kit
	

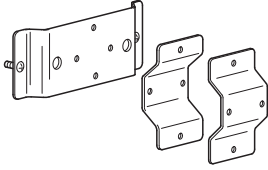
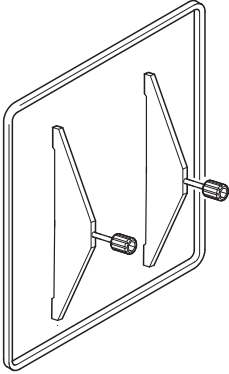
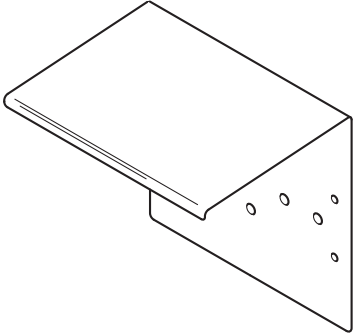
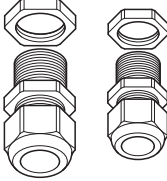
Part No.	Description
AWT440720	AWT440 processor board spares kit
	
AWT440721	AWT440 AC main board spares kit
	
AWT440722	AWT440 DC main board spares kit
	
AWT440723	AWT440 analog output PCB spares kit
	
AWT440727	AWT440 dual channel sensor input PCB (digital RS485)
	
AWT440728	AWT440 SD media PCB spares kit
	
AWT440729	AWT440 USB media PCB spares kit
	

C.3 Optional accessories

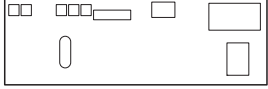
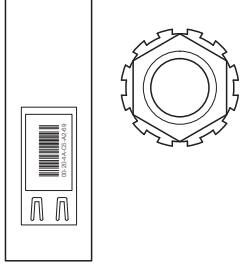
Part No.	Description
AWT440700	AWT440 pipe mounting kit 
AWT440701	AWT440 panel mounting kit 
AWT440702	AWT440 weathershield kit 
AWT440705	AWT440 standard cable gland pack 
AWT440706	AWT440 ethernet cable gland pack 

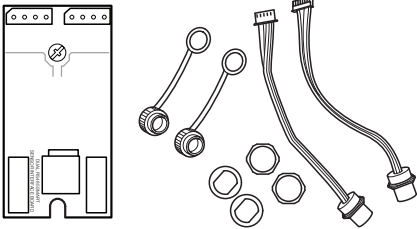
Part No.	Description
AWT440725	AWT440 Profibus ¹ PCB spares kit 
AWT440726	AWT440 Ethernet PCB spares kit 
AWT440730	AWT440 MODBUS ² PCB spares kit 
AWT440732	AWT440 dual channel sensor input upgrade kit 

1. Profibus is a registered trademark of Profibus organization
2. MODBUS is a registered trademark of the Modbus-IDA organization

Notes

Notes

Sales



Service



Software



ABB Limited

Measurement & Analytics

Oldends Lane, Stonehouse

Gloucestershire,

GL10 3TA

UK

Tel: +44 (0)1453 826661

Fax: +44 (0)1453 829671

Email: instrumentation@gb.abb.com

ABB Inc.

Measurement & Analytics

125 E County Line Road

Warminster, PA 18974

USA

Tel: +1 215 674 6000

Fax: +1 215 674 7183

abb.com/measurement



We reserve the right to make technical changes or modify the contents of this document without prior notice. With regard to purchase orders, the agreed particulars shall prevail. ABB does not accept any responsibility whatsoever for potential errors or possible lack of information in this document.

We reserve all rights in this document and in the subject matter and illustrations contained therein. Any reproduction, disclosure to third parties or utilization of its contents – in whole or in parts – is forbidden without prior written consent of ABB.