

INSTRUCTIONS FOR THE LCR20 TEN INCH CIRCULAR CHART RECORDER



LOVE CONTROLS

a Division of Dwyer Instruments, Incorporated
PO Box 338 ○ Michigan City, IN 46361-0338
(800) 828-4588 ○ (219) 879-8000 ○ FAX (219) 872-9057
www.love-controls.com

Contents

Chapter 1 Overview

1-1 General	3
1-2 Model Identification	3

Chapter 2 Installation

2-1 Unpacking	4
2-2 Mounting	4
2-3 Case Location	5
2-4 Wiring Precautions	6
2-5 Power Wiring	7
2-6 Sensor Installation Guidelines	8
2-7 Thermocouple Input Wiring	9
2-8 RTD Input Wiring	10
2-9 Linear DC Input Wiring	10
2-10 Alarm Relay Wiring	10
2-11 Changing the Chart	11
2-12 Marking Systems	11
2-13 Replacement of Pen	12
2-14 Battery Backup	13

Chapter 3 Programming

3-1 Recorder Setup	14
3-2 Alarm Settings	15

Chapter 4 Calibration

.....	16
-------	----

Chapter 5 Specifications

.....	18
-------	----

Chapter 6 Dimensions

.....	19
-------	----

Chapter 7 Green LED Troubleshooting Guide

.....	20
-------	----

Chapter 1 Overview

1-1 General

The LCR20 is a microprocessor based 10 inch circular chart recorder. Programmable alarm options combined with “ease of setup” provide the flexibility required for a multitude of recording applications.

The Ink style LCR20 is the first recorder with “self documenting” configuration during initial setup. It can operate using standard or competitive charts. The battery backup feature provides up to 48 hours of recording in the event of a power loss, providing an additional degree of protection for customer processes.

A unique setup template provides the user with an “on the spot” manual. This setup template will also self document the current setup for quick review by an operator.

These units are powered by a field selectable 110/220VAC 50/60Hz. supply. A 9 Volt battery allows for operation for up to 48 hours if the main power supply fails. Standard inputs are programmable for thermocouple types J, K, T, R, B and S as well as 4-20mA or 0-5 VDC.

Optional alarm relay is available and programmable for low, hi, or band in latching or non-latching operation.

High accuracy, maximum flexibility, fast response and a simple interface are the main benefits of the LCR20 recorder.

1-2 Model Identification

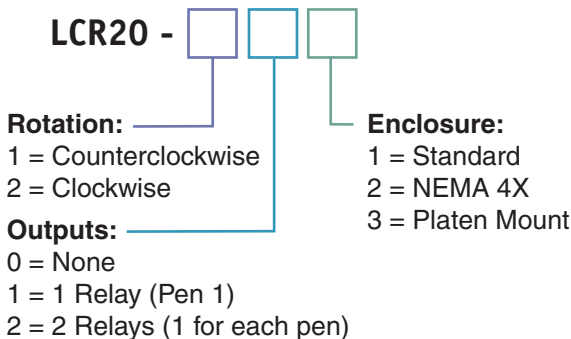

Chapter 2 Installation



Dangerous voltages capable of causing serious injury or death are sometimes present in this instrument.



Before installation or beginning any troubleshooting procedures, the power to all equipment must be switched off and isolated. More than one power disconnect may be required.



Units suspected of being faulty must be disconnected and removed to a properly equipped workshop for testing and repair. Component replacement and internal adjustments must be made by a qualified maintenance personnel only.



To minimize the possibility of fire or shock hazards, do not expose this instrument to rain or excessive moisture.



Do not use this instrument in areas under hazardous conditions such as excessive shock, vibration, dirt, moisture, corrosive gases or oil. The ambient temperature of the areas should not exceed the maximum rating specified in Chapter 5.

2 - 1 Unpacking

Upon receipt of the shipment remove the unit from the carton and inspect the unit for shipping damage.

If any damage due to transit, report and claim with the carrier. Write down the model number, serial number, and date code for future reference when corresponding with our service center. The serial number (S/N) and date code (D/C) are labeled on the box and the platen of the unit. Make sure that all items are accounted for:

- 1: Battery (for battery backup)
- 2: Installation manual

2 - 2 Case Location

Upon unpacking, find a suitable location to mount the recorder before wiring power to the unit.

Select a location that is well lighted, free from dust, dirt, or corrosive fumes. The recorder should not be located near any sources of heat or be subjected to sudden or extreme temperature changes. It should be mounted on a rigid support that is not subject to vibration.

2-3 Mounting

Make panel cutout to dimension shown in Figure 2-1.

Install both mounting clamps and insert the case into the panel cut out.

Dimensions are in millimeters (inches).

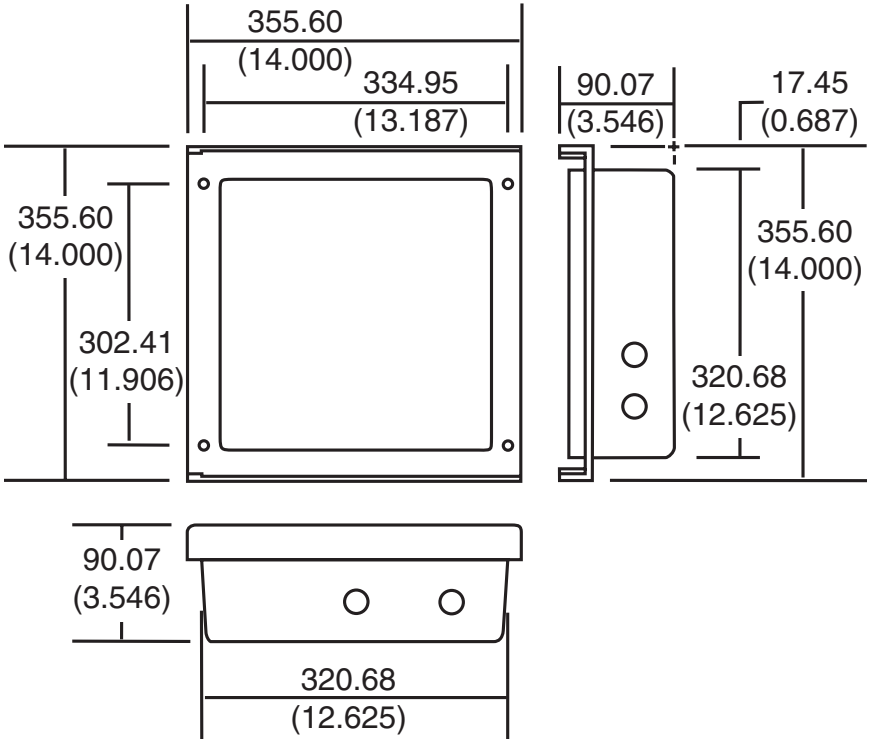











Figure 2-1

2-4 Wiring Precautions

-  Before wiring, verify the label for correct model number and options. Switch off the power when checking.
-  Care must be taken to ensure that maximum voltage rating specified on the label are not exceeded.
-  It is recommended that power of these units to be protected by fuses or circuit breakers rated at the minimum value possible.
-  All units should be installed inside a suitably grounded metal enclosure to prevent live parts being accessible from human hands and metal tools.
-  All wiring must conform to appropriate standards of good practice and local codes and regulations. Wiring must be suitable for maximum voltage, current, and temperature rating of the system.
-  Take care not to over-tighten the terminal screws.

-  Unused control terminals should not be used as jumper points as they may be internally connected, causing damage to the unit.
-  Verify that the ratings of the output devices and the inputs as specified in Chapter 5 are not exceeded.
-  Electric power in industrial environments contains a certain amount of noise in the form of transient voltage and spikes. This electrical noise can enter and adversely affect the operation of microprocessor-based controls. For this reason we strongly recommend the use of shielded thermocouple extension wire which connects the sensor to the unit. This wire is a twisted-pair construction with foil wrap and drain wire. The drain wire is to be attached to earth ground at the sensor end only.

2-5 Power Wiring

The unit is supplied to operate at 110/220VAC 50/60Hz. Check that the installation voltage corresponds with the power rating indicated on the product label before connecting power to the unit.

The recorder uses AC power when it is operating normally. The battery backup option will allow the recorder to operate for approximately 48 hours in case of a power loss.

In order to connect the recorder to the main AC power, you must first gain access to the microprocessor PC board that is mounted to the back of the chart plate. Your recorder will have a hinged chart plate held in place by two (2) screws located on the right hand side of the chart plate. Remove these two screws and open the hinged chart plate. If you are not sure how to access the back of the chart plate. See Figure 2-5 (pg. 13) for screw location.

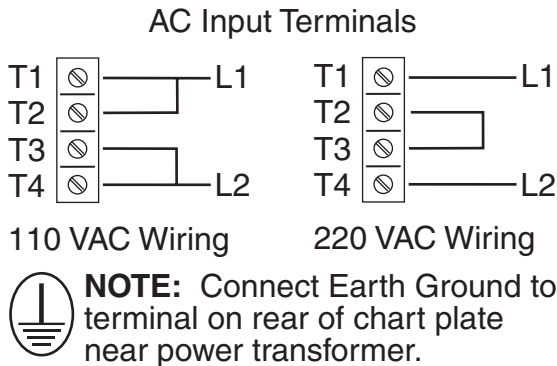

Figure 2-2

The AC power connections are made to terminal block location on the back side of the chart plate of the recorder. Refer to Figure 2-2 for proper connection to the main AC power.



This equipment is designed for installation in an enclosure which provides adequate protection against electric shock. The enclosure must be connected to earth ground.

Local requirements regarding electrical installation should be rigidly observed. Consideration should be given to prevent unauthorized or accidental access to the power terminals.

2-6 Sensor Installation Guidelines

Proper sensor installation can eliminate many problems in a control system. The probe should be placed so that it can detect any temperature change with minimal thermal lag. In a process that requires fairly constant heat output, the probe should be placed close to the heater. In a process where the heat demand is variable, the probe should be close to the work area. Some experiments with probe location are often required to find this optimum position.

Proper sensor type is also a very important factor to obtain precise measurements. The sensor must have the correct temperature range to meet the process requirements. In special processes the sensor might need to have different requirements such as leak-proof, anti-vibration, antiseptic, etc.

Standard thermocouple sensor limits of error are 2 degrees C (4 degrees F) or 0.75% of sensed temperature (half that for special limits of error) plus drift caused by improper protection or an over-temperature occurrence. This error is far greater than recorder error and cannot be corrected at the sensor except by proper selection and replacement.

In order to connect the probe input device to the recorder, you must first gain access to the microprocessor PC board that is mounted to the back of the chart plate.



CAUTION! DO NOT TOUCH the terminals of the transformer while the recorder is connected to the main AC power supply. To avoid the risk of possible electric shock, unplug or disconnect the recorder from the main power supply before attempting to open the recorder. Also, disconnect the 9 Volt battery to avoid damaging the recorder and draining the battery.



The recorder has a hinged chart plate held in place by two (2) screws located on the right hand side of the chart plate. Remove these two screws and open the hinged chart plate. See Figure 2-5 (pg. 13) for screw location.

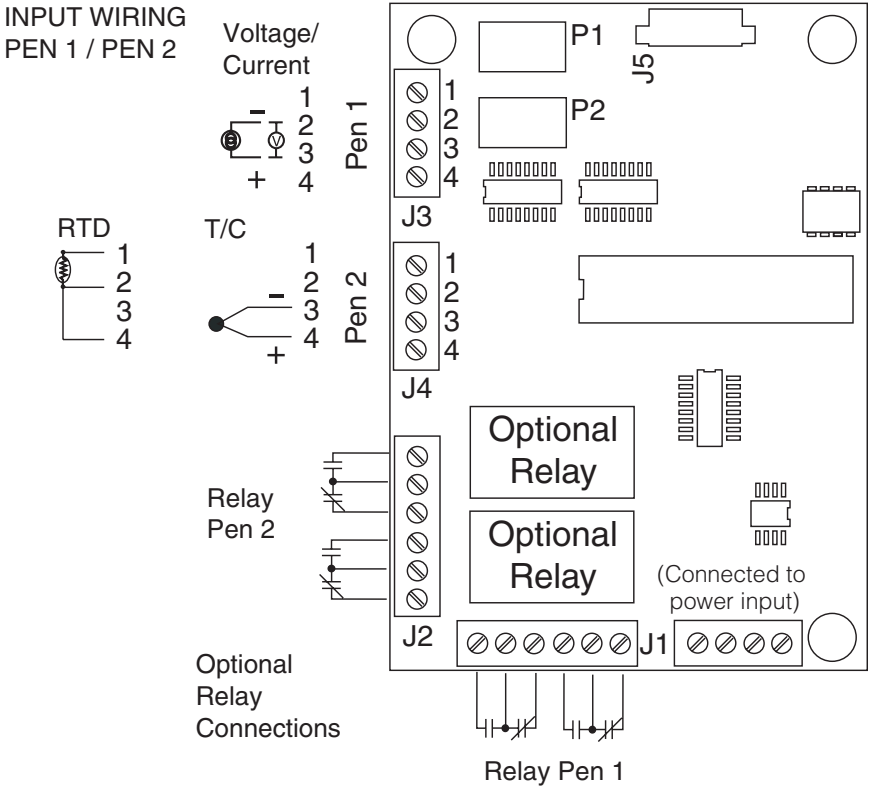

Figure 2-3 Input/Relay wiring - PCB layout

2-7 Thermocouple Input Wiring

Thermocouple input connections are shown in Figure 2-3. The correct type of thermocouple extension lead-wire or compensating cable must be used for the entire distance between the unit and the thermocouple, ensuring that the correct polarity is observed throughout. Splices in the cable should be avoided, if possible.

If the length of thermocouple plus the extension wire is too long, it may affect the temperature measurement. A 400 ohms K type or a 500 ohms J type thermocouple lead resistance will produce approximately 1 degree C temperature error.

2-8 RTD Input Wiring

Two-wire RTD's should be used in short lead lengths, if possible, for the purpose of accuracy. A 0.4 ohm lead resistance of a two-wire RTD will produce 1 degree C temperature error. RTD connection are shown in Figure 2-4, with the compensating lead connected to terminal 4. For two-wire RTD inputs, terminals 2 and 4 should be linked. The three-wire RTD offers the capability of lead resistance compensation provided that the three leads are of same gauge and equal length.

2-9 Linear DC Input Wiring

DC linear voltage and linear current connections are also shown in Figure 2-5. Terminal 2 = negative. Terminal 3 = positive.

2-10 Alarm Relay Connections

If your recorder has the optional relay contacts installed, then terminal blocks J1 and J2 have been provided for connection to the relay on the microprocessor PC board of the recorder. Refer to Figure 2-4 (page 9) for the location of J1 and J2 on the microprocessor PC board.



CAUTION! DO NOT TOUCH the terminals of the transformer while the recorder is connected to the main AC power supply. To avoid the risk of possible electric shock, unplug or disconnect the recorder from the main power supply before attempting to access the terminals of the relay. If the recorder is installed with the battery back-up option, disconnect the 9 Volt battery to avoid damaging the recorder and draining the battery.



The recorder has a hinged chart plate held in place by two (2) screws located on the right hand side of the chart plate. Remove these two screws and open the hinged chart plate. See Figure 2-5 (pg. 13) for screw location.

The relay(s) is (are) rated for the following maximum Values:

2.0 AMPS at 25VDC, 1.0 AMP at 120VAC



Warning: Damage to the recorder may result if the ratings for the relay is exceeded.

2-11 Changing the Chart

Press and release the CHANGE CHART button (#3), Figure 3-1 (pg. 14). The pens will move to the left of the chart and the LED begins blinking rapidly. Unscrew (counterclockwise) the chart “hub” knob at the center of the chart. Wait until the pens stop above outer ring AND the green LED goes to on steady.

Remove the old chart paper and position the new one so that the correct time line coincides with the time line groove on the left side of the chart plate.

Refer to Figure 2-5 (pg. 13) for the location of the time line groove.

Re-attach the chart “hub” knob and screw securely (by hand) against the chart. Press and release the CHANGE CHART button (#3). The pens will move to the outer ring and then pause. The LED remains on.

The pens will move to the current input values. Check to make sure that the pens are marking on the chart paper. If not, then carefully adjust the pen arm to establish contact with the paper.

2-12 Chart Pens

The chart pen consists of a self contained ink reservoir with a porous plastic stylus which is fastened around the outer edge of the metal pen arm.

A pen cap is provided to extend the life of the ink pen during shipping or when the recorder is not in service. To remove the pen cap, gently lift the pen arm away from the chart paper. Remove the black plastic pen cap to expose the fiber tip of the ink pen and gently place the pen back onto the chart paper. Do not let the pen arm “snap” back onto the chart paper. This will flatten the fiber tip of the pen and will no longer give you a fine line marking on the chart paper. Place the pen cap in a safe place for future use.

If the stylus does not touch the chart, adjustment can be made by slightly bending the metal pen arm in the center towards the chart paper. Do not use more pressure than is necessary to create a fine line marking on the chart paper. Note: As the pen ink supply runs out, the pen color will become lighter. This indicates that the pen should be replaced.

2-13 Pen Installation / Replacement

Recorders that are equipped with fiber tipped cartridge pens will have a cartridge that is color coded “red” for Pen 1 and “blue” for Pen 2.

The pen cartridge is securely fastened to the metal pen arm using a special “U” clip tab.

For ease of replacement, it is suggested that the two (2) screws that hold the pen arm be loosened and the pen cartridge and metal pen arm be removed as an assembly. Refer to Figure 2-5, pg.13, for the location of the pen arm screws. Unsnap the plastic “U” clip tab of the pen cartridge from the metal pen arm, remove and discard the old pen cartridge. Replace the new cartridge by opening the hinge and snapping it securely around the metal pen arm. Refer to the Figure 2-4 .

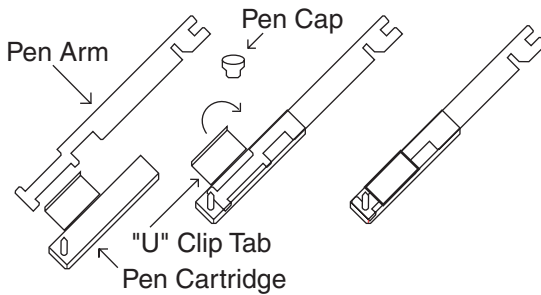

Figure 2-4 Pen Installation / Replacement

2-14 Battery Backup

Having the 9 volt DC battery back-up in place, will allow the recorder to continue to function normally for approximately 48 hours in the event of a power failure.

The battery strap and battery holder are located on the front of the chart plate (refer to Figure 2-5). In order to change the battery, you must open the recorder case door. Note: Use only NEW 9 volt alkaline replacement batteries.

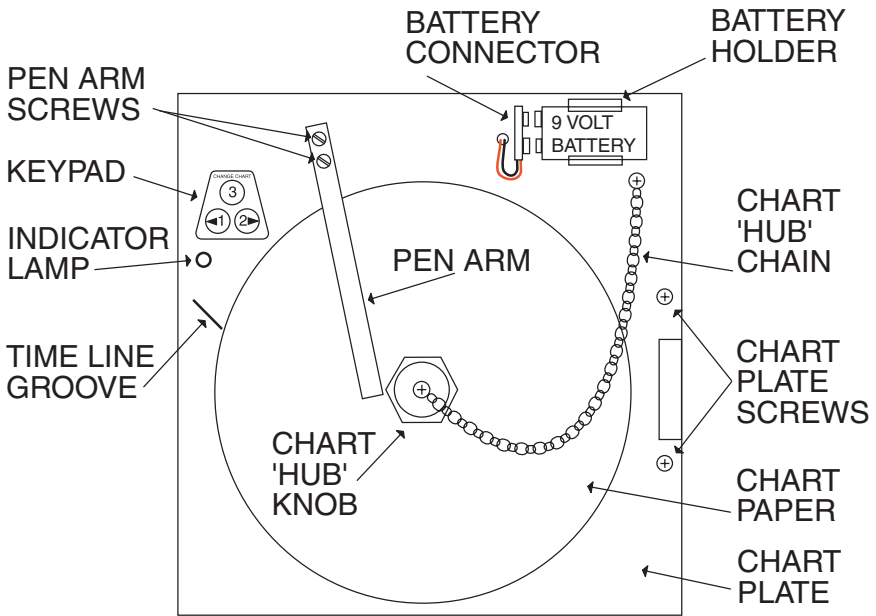

Figure 2-5 Recorder Platen Layout/Battery Installation



CAUTION! DO NOT TOUCH the terminals of the transformer while the recorder is connected to the main AC power supply. To avoid the risk of possible electric shock, unplug or disconnect the recorder from the main power supply before attempting to access the terminals of the relay. If the recorder is installed with the battery back-up option, disconnect the 9 Volt battery to avoid damaging the recorder and draining the battery.



Chapter 3 Programming

3-1 Recorder Setup

In order to configure the recorder, you will need the recorder SET-UP CHART, P/N R18-270 for CCW rotation or P/N R18-272 for CW rotation. This chart contains the configuration categories for the recorder (Probe Input, Inner Chart Values, Outer Chart Values, Scale Units, Chart Rotation Speed, Input Averaging and Relay Options).

1. Place the SETUP CHART on the recorder.
2. Press and release the CHANGE CHART key (3). Wait until pens move above scale and green LED stops flashing.
3. Press and hold the LEFT arrow key (1) until the LED goes off, then release the key. The Pen will move to the outer ring of the chart. Wait for the LED to flash slowly (.8 sec on / .8 sec off). The LED will continue to flash slowly during setup.
4. The Blue pen will move to the outer ring of the SET-UP CHART first. Then the Red pen will move to the outer ring. Note that the Blue pen selection is valid only for the Input Probe category.
5. Loosen the Chart Knob and rotate the chart to position the RED pen in the middle of the START CIRCLE.
6. Tighten the chart knob. Press and release the CHANGE CHART key (3). The Red Pen will move to the first selection of the first category on the setup chart. Using the LEFT (1) and RIGHT (2) keys, move the Red pen to the desired selection.
7. Press and release the CHANGE CHART key (3) to store the selection. The Blue pen will then advance to the next category. Using the LEFT (1) and RIGHT (2) keys, move the Blue pen to the desired selection. Press and release the CHANGE CHART key (3) to store the selection. The Blue pen will then move to the outer ring and remain there. Blue pen shares red pen range programming.
8. Repeat selection process until all categories are programmed. You must press and release the CHANGE CHART key (3) after the last category.
9. After all categories are selected, the pen will move off scale and the LED will Stop flashing. (Steady on). Setup is now complete.
10. Remove the SETUP CHART and save. Install an actual recording chart.

Press and release the CHANGE CHART (#3) key to begin recording.

The SET-UP CHART should be saved for future reference.

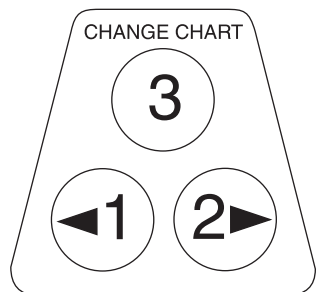

Figure 3-1 Keyboard Layout

3-2 Alarm Settings

Alarm setpoint values are selected by positioning the appropriate pen to the actual value on the recording chart. Alarm settings can be changed or viewed after a CHART CHANGE, recorder setup, or during initial power up. To set the alarm setpoint during normal recording operation, complete the following steps.

Press and release the CHANGE CHART key (3 on Figure 3-1). Wait until the active pen moves off scale AND the LED stops flashing quickly and goes to a steady on. Press and release the CHANGE CHART key (3) again. The pen will begin to move back onto the chart briefly stopping at (or close to) the outermost graduation of the chart. The Green LED remains on steady during this time.

Single Alarm Setting

When the above operation is complete, the pen will move to the current alarm setpoint position on the chart. The green LED will go out, during this time the alarm setpoint can be adjusted using the LEFT arrow (1) or the RIGHT arrow (2) keys on the keypad. Once the alarm setpoint is set, wait for the green LED to turn on. The pen will then move to indicate the input value and the unit will begin normal recording operation.

Band Alarm Setting

When programming the recorder for band operation, the active pen will move first to alarm band 1 setpoint on the chart. The green LED will go out. The alarm band 1 setpoint can now be adjusted using the LEFT arrow (1) or the RIGHT arrow (2) keys. Once set, wait for the green LED to turn on. The active pen will then move to the second band alarm setpoint. The green LED will go out. The alarm band 2 setpoint can now be adjusted using the LEFT arrow (1) or the RIGHT arrow (2) keys. When pen alarm setpoints adjustments are complete, wait for green LED to turn on. The pen will then move to the current input value and recorder will begin normal operation.

The "Change Chart" key is the "RESET" when the recorder is programmed for latching alarm operation. Please note that the relay will only reset if alarm condition has been cleared.

Chapter 4 Calibration

4-1 Pen Arm Calibration

Pen calibration is a two point calibration. To check and/or adjust the recording pen(s) calibration to the inner and outer graduations of the chart,

Perform the following.

1. Remove power to instrument and remove the battery.
2. With all power removed, press and hold the CHANGE CHART key (3). While holding the CHANGE CHART key(3), re-apply power. Release key upon applying power, either AC or battery, which ever is convenient.
3. The pens will move off scale, The LED will flash rapidly. The Green LED will then go to steady on.
4. The Blue pen will then move to the 100% ring. Adjust the Blue pen using the LEFT (1) and RIGHT (2) keys to position pen on the 100% ring, if necessary, Then Wait.
5. The red pen will then move to the 100% ring. Adjust pen using the LEFT (1) and RIGHT (2) keys to position pen on the 100% ring, if necessary, Then Wait.
6. The Red pen will then move to the 0% ring. Adjust the pen position using the LEFT (1) and RIGHT (2) keys, if necessary, then wait. The Red pen will then move full upscale.
7. The Blue pen will then move to the 0% ring. Adjust the pen position using the LEFT (1) and RIGHT (2) keys, if necessary, then wait. The Blue pen will then move full upscale.

If unit has alarms enabled pens will now go to current alarm settings (See Section 3.2), then to the actual recording values.

If no alarms are enabled pen will then go directly to actual recording values and begin normal operation.

Each time the chart paper or fiber tip pen cartridge is changed, you should make sure that each pen stops at the inner and outer most temperature graduations of the chart paper. Otherwise, this pen offset can cause the unit to record an incorrect value on the chart.

4-2 Probe Offset Adjustment (pen offset)

This recorder has been accurately calibrated at the factory. Before making any adjustments, this instrument should be in service for 24 hours.

Thereafter, if any adjustment is required, perform the following procedure.

1. Place a Certified Test indicator alongside the recorder's sensor probe in a monitored controlled condition.
2. Once the input has leveled out, compare the position of the pen on the recorder to the reading on the test device.
3. If an adjustment is required, first select the pen needing calibration. Press the LEFT (1) arrow key to select the Red pen or the RIGHT (2) arrow key to select the Blue pen. The appropriate key must be held down for about five (5) seconds, until the green LED turns off. Once the LED turns off, release the key. The LED will begin to flash steadily.
4. To adjust the pen position, use the LEFT arrow (1) or RIGHT (2) arrow keys to position the pen on the chart to correspond to the value of the test device. Once the corrected value is obtained no further keystrokes are required.

After the calibration check is complete, the recorder will return to normal recording mode within 10 seconds. The LED returns to the steady on state to indicate that normal operation has resumed.

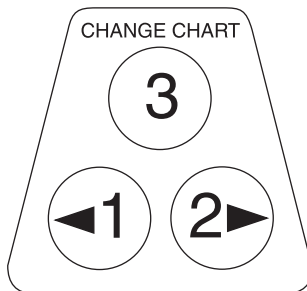

Figure 4-1

Chapter 5 Specifications

Input 1:

Thermocouple: Type J, K, T, R, S, B.

RTD: 100 Ohm Platinum DIN Curve (0.00385 ohms per ohm per degree C)

Process: 0 to 5 VDC, 250 Ohms impedance.

4 to 20 mA across 250 Ohms.

Cold Junction Accuracy: $\pm 0.2^{\circ}\text{C}$ @ 25°C ambient.

Cold Junction Error: $\pm 0.2^{\circ}\text{C}$ @ 25°C ambient.

Input Filtering: Programmable, 0, 2, 4, 8, 16, 32, 64, 128 seconds.

Input 2:

Process: 0 to 5 VDC, 250 Ohms impedance.

4 to 20 mA across 250 Ohms.

Recording:

Chart Size: 254 mm (10 inches)

Recording Accuracy: $\pm 0.5\%$ of span (100 division span)

Sensor Break: Full scale pen < 10 seconds.

Chart Speed: Programmable, 4, 8, 12, 24, 48, 72, 168 hour rotation (168 hours = 7 days).

Output Relay: Form C (DPDT), 1A @ 240VAC Resistive.

Power:

Line Voltage: 110/220 VAC $\pm 10\%$, 50~60 Hz.

Common Mode Rejection: >120db @ 60 Hz.

Normal Mode Rejection: 85dB @ 60 Hz.

Power Consumption: 15 VA maximum.

Backup Battery: 9 Volt alkaline (IEC 6LR61 or equivalent).

Operational and Physical:

Operating Temperature: 0 to 60°C (32 to 140°F)

Storage Temperature: -40 to 65°C (-40 to 150°F)

Humidity: 0 to 90% RH (non-condensing)

Vibration: 0.3 to 100 Hz @ 0.2g

Mounting: ± 20 degrees of vertical, ± 10 degrees of horizontal.

Dimensions: See drawing.

Panel Ratings: NEMA 12X standard, NEMA 4X optional

Moldings: Fire retardant Noryl w/ acrylic window.

Weight: 3.2 kg (7.0 pounds) maximum.

Input Ranges

Input Signals			
SENSOR	TYPE	RANGES	
Thermocouple	J	-130 to 760°C	-202 to 1400°F
Thermocouple	K	-130 to 1360°C	-202 to 2498°F
Thermocouple	T	-200 to 400°C	-328 to 752°F
Thermocouple	R	0 to 1650°C	32 to 3002°F
Thermocouple	S	0 to 1650°C	32 to 3002°F
Thermocouple	B	100 to 1824°C	212 to 3315°F
RTD	100 Ohm Plt. DIN	-210 to 440°C	-346 to 824°F
DC Voltage: 0 to 5 VDC, linear.		0 to 100% of the chart span.	
DC Current: 4-20mA, linear.			

Chapter 6 Dimensions

Dimensions are in millimeters (inches).

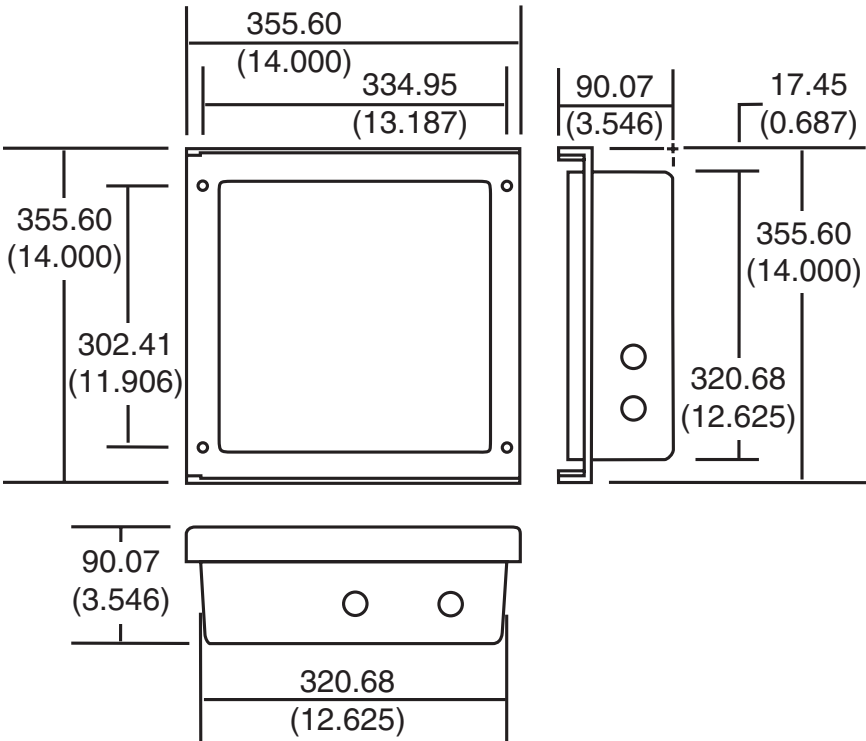

7 - GREEN LED Troubleshooting Guide

7 - 1 LED LIGHT SEQUENCE GUIDE

- 1.) LED on steady and pen(s) within chart range, unit is recording normally.
- 2.) LED on steady and pen(s) above 100% ring indicates unit is in "CHART CHANGE" mode.
Action: Press and release "CHART CHANGE" key to return to normal recording mode.
- 3.) LED flashing RAPIDLY and pen(s) within chart range indicates battery voltage is low.
Action: Replace battery.
- 4.) LED flashing RAPIDLY and pen(s) at 0 or 100 % ring indicates that input sensor(s) are in a break condition.
Action: Check or replace sensor, validate setup information for sensor.
- 5.) LED flashing slowly (.8 sec.. On/ .8 sec. off) indicates the unit is in setup mode.
Action: Complete setup procedure of recorder.
- 6.) LED not on indicates no power to unit.
Action: Check to see if AC present on power terminals. Check and / or replace battery.