

FEMALE END VIEW

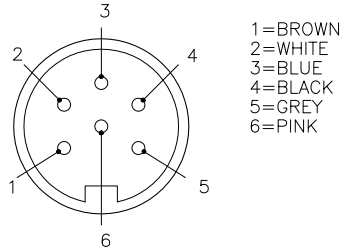

M16 connector

SPECIFICATIONS

CONTACT CARRIER MATERIAL/COLOR	TPU/BLACK
CONTACT MATERIAL/PLATING	BRASS/GOLD
HOUSING MATERIAL/PLATING	BRASS/NICKEL
O-RING MATERIAL	NITRILE (BUNA N)
RATED CURRENT [A]	7.0 A
RATED VOLTAGE [V]	300 VAC/VDC
CONDUCTOR INSULATION MATERIAL	PVC
NUMBER OF CONDUCTORS [AWG]	6x18 AWG
TEMPERATURE RANGE	-40°C to +105°C (-40°F to +221°F)
PROTECTION CLASS	MEETS NEMA IEC IP67

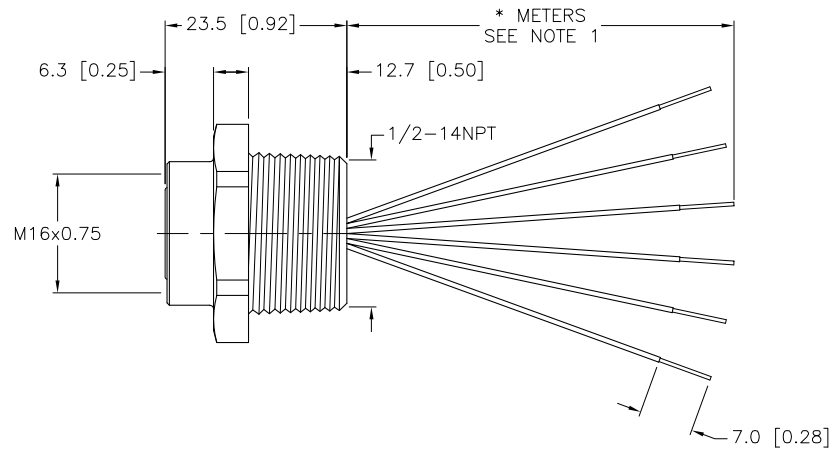
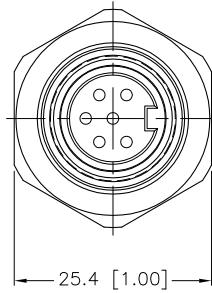

CABLE LENGTH	TOLERANCE
ALL LENGTHS	+ 4% (OR 50mm) OF LENGTH - 0% (OR 0mm) OF LENGTH WHICHEVER IS GREATER
STRIP LENGTH	TOLERANCE
0-7mm	±0.5mm
8-29mm	±1.0mm
30-49mm	±2.0mm
50-69mm	±3.0mm
70-100mm	±4.0mm
OVER 100mm	±5.0mm

NOTES:

1. "*" INDICATES LEAD LENGTH IN METERS. CONTACT TURCK TO ORDER SPECIFIC LENGTH.

SOURCE DRAWING - FOR REFERENCE ONLY

RELATED DOCUMENTS 1. 2. 3. 4.	3RD ANGLE PROJECTION 	THIS DRAWING IS PROPERTY OF TURCK INC. USE OF THIS DOCUMENT WITHOUT WRITTEN PERMISSION IS PROHIBITED.		3000 CAMPUS DRIVE MINNEAPOLIS, MN 55441 1-800-544-7769 (763) 553-7300 (763) 553-0708 fax turck.com	
		MATERIAL SEE SPECIFICATION	DRFT RWC DSGN	DATE 09/30/04 SCALE 1=1.0	DESCRIPTION BKF 6-6-*/14.5/NPT
FINISH SEE SPECIFICATION	ALL DIMENSIONS DISPLAYED ON THIS DRAWING ARE FOR REFERENCE ONLY CONTACT TURCK FOR MORE INFORMATION	UNIT OF MEASUREMENT MILLIMETER [INCH]		IDENTIFICATION NO.	
DO NOT SCALE THIS DRAWING		FILE: 777009763		REV C	

C	DRAWING PROCESSED AS PART OF ECO 33971	CBM	04/06/11	33971
REV	DESCRIPTION	BY	DATE	ECO NO.