

ABB MEASUREMENT & ANALYTICS | DATA SHEET

Aztec 600 Ammonia

Ammonia analyzer



Measurement made easy

Reliable on-line monitoring of ammonia for potable water applications

Reliable ammonia measurement

- automatic 2-point calibration
- automatic sample dilution to maximize range
- automatic background color compensation
- analysis of up to 3 sample streams

Easy to operate

- familiar Windows™ menu system
- built-in context-sensitive help
- data trending and analysis

Easy to maintain

- self-cleaning measurement cell
- simple-to-perform annual service
- helpful maintenance diagnostics screens

Full communications

- web- and ftp-enabled for easy data file access, remote viewing and configuration
- email capability
- optional Profibus® DP V1.0

Introduction

The Aztec 600 colorimetric series of analyzers from ABB are a range of range of compact, yet reliable, on-line colorimetric analyzers for the key parameters in water treatment.

They combine the unique Aztec fluid handling system with the latest electronics platform, featuring Windows menu-driven software, to create a range of analyzers simple-to-operate and maintain; capable of measuring up to three sample streams.

The Aztec 600 Ammonia analyzer has been designed specifically for the measurement of ammonia in potable water applications. It offers reliable and accurate, on-line analysis of ammonia up to 3 ppm.

All the sample and chemical fluid handling for measurement, mixing and disposal is controlled precisely by the patented Aztec fluid handling system that cleans the measuring cell with every movement.

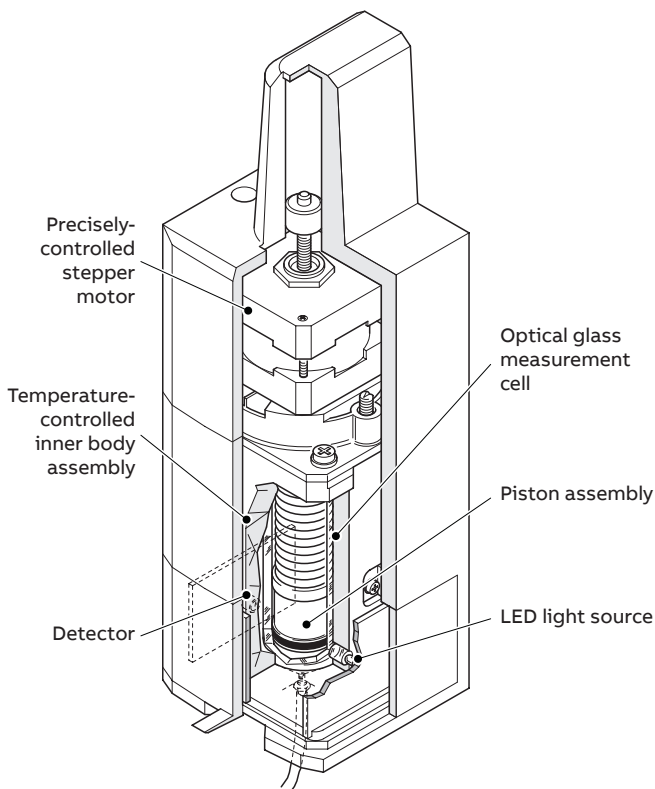

Measuring head detail

Users of this system also benefit from the Aztec 600 Ammonia's low maintenance requirements, ease of use, auto-calibration, adjustable frequency of measurement and proven chemistry methodology.

Process data, as well as the content of alarm and audit logs, can be saved to a removable SD card for record keeping and analysis using ABB's DataManager data analysis software.

User benefits of on-line ammonia monitoring

The task of managing the quantity of water resources and the quality of drinking water today is unimaginable without on-line instrumentation that helps water utilities manage, treat and deliver drinking water to consumers.

On-line monitoring provides plant operators with an early warning of any changes to the treatment process, enabling operational decisions to be made in near real-time. This level of process control is not possible with manual testing alone, where potentially important events that occur between less frequent manual sampling can be missed.

Users of the Aztec 600 Ammonia analyzer benefit from:

- Improvements in process control
 - enables operational decisions to be made in near real-time.
- Improvements in process reliability
 - detect process failures before they affect the quality of the water leaving the plant.
- Process optimization for water quality
 - increased plant efficiency.
- Potential capital and operating cost reductions
 - reduction in chemical and energy usage.
- Continual monitoring of remote or un-staffed sites
 - improved response times and reduced visits saving money and time whilst lowering carbon footprint.
- Improved reporting
 - analyzer audit trail data can be used to assure customers and regulators of process efficiency and consistent product quality.

Applications

Typical applications for the Aztec 600 Ammonia include:

- Monitoring of ammonia through the treatment process:
 - monitoring of ammonia levels in raw waters from rivers for intake protection

Overview of the Aztec 600 Ammonia analyzer

Easy-to-use Windows-based menu system



Graphical trending of results

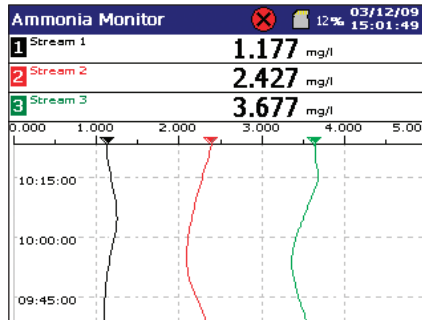

Flexible communications

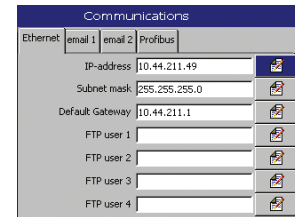

- Ethernet connectivity
- 6 mA outputs
- 10 alarm relays (configurable)
- Profibus DP v1.0
- SD memory card
- Process data trends

Simple navigation

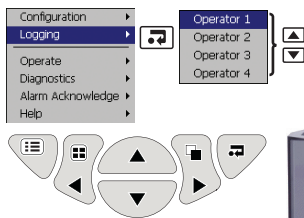

Advanced optics

- Automatic LED intensity adjustment at every calibration – eliminates drift and compensates for any cell fouling
- Temperature-controlled for optical stability
- Automatic 2-point calibration
- Automatic sample dilution to maximize measurement range
- Background sample color compensated for

Single- or multi-stream options

- Integrated side-sample pot for ease of plumbing
- Magnetic sample flowswitch alarms when sample is not present

Simplified fluid handling

- Single piston pump draws in precise volumes of reagents and samples through a valve manifold into the optical measuring cell
- Air is used in the chemical sequence for mixing and purging the reagents and sample
- Piston movement provides mechanical cleaning the measurement cell

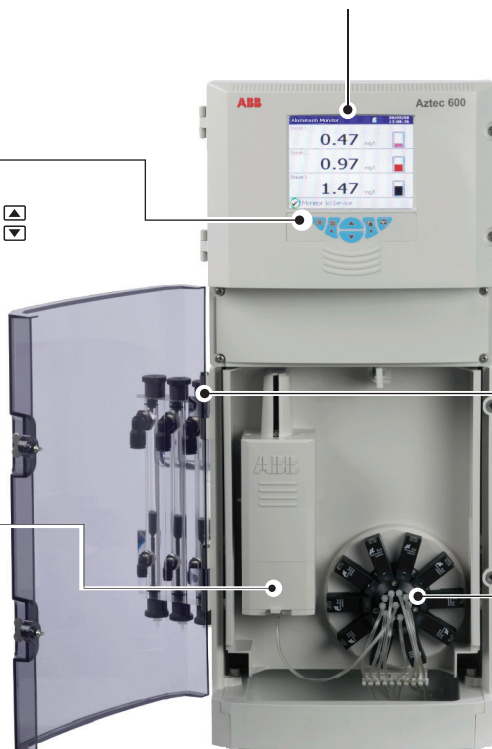

Reliable measurement

The Aztec 600 Ammonia is an on-line colorimetric analyzer. It has been designed for ease-of-use and maintenance simplicity, while offering the benefits of flexible communication and advanced data acquisition.

The Aztec 600 Ammonia can measure up to 4 samples per hour using the indophenol blue chemistry to measure ammonia and ammonium ions..

A fully-programmable multi-stream option is available, providing up to 3-stream capability with user-programmable stream sequencing.

Fluid handling

A single piston pump provides all the sample and chemical fluid handling for measurement, mixing and disposal. The pump is stepper motor controlled for repeatability and precision.

This 'motorized syringe' approach has the added benefit of wiping the optical cell on every movement of the piston, resulting in a highly efficient automatic cleaning process.

This is particularly important when measuring waters where optical contamination can be a real issue without having stringent automatic cleaning.

Measurement technique

The optical cell is rinsed thoroughly with sample before measurement, eliminating dead zones and enabling multi-stream measurement across different samples without cross contamination.

To correct for any natural coloration of the sample, the background absorbance of the sample is measured prior to the addition of any color-forming reagents to provide a sample blank.

Reagents are then added and mixed to produce a colored solution that can be measured and converted to a concentration value.

Instead of using a mechanical stirring system, the piston and optical sensor is utilized further by drawing in air after the sample and reagents are introduced. This provides turbulence and efficient mixing without any of the cost and maintenance drawbacks of mechanical and electrical mixing systems.

The Aztec 600 Ammonia analyzer has the capability to enable an automated chemical cleaning routine. This programmable rinse routine enables a separate acid / alkali or biocide to be drawn through the sample tubing and optical cell.

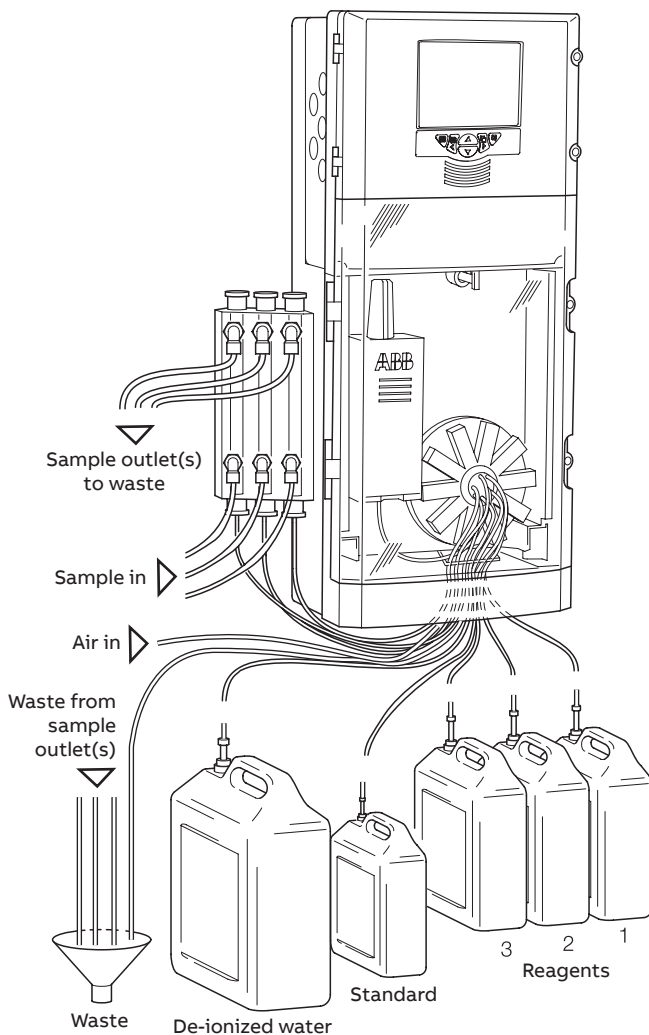

Example of multi-stream installation

Simple to operate

The powerful and user-friendly Windows menu-driven software enables user's to operate the analyzer with the minimum amount of training.

The comprehensive range of available menu screens is simple-to-access using the 6 membrane keys.



Windows-based interface

These menus include data logging and graphical trending screens, operation command screens, full setup configuration screens and a range of self-diagnostics (including full calibration and operating status screens).

Historical logs provide operators with access to alarm logs and audit trail data. Process data and historical logs are archived securely to a removable SD card.

All information is displayed clearly on the easy to read 145 mm (5.7 in.) color LCD display and is available in a range of languages.



Communications window

Simple to maintain

The Aztec 600 colorimetric range is designed to be as maintenance-free as possible. The inherent product design and auto-calibrating features reduce the amount of maintenance required to external cleaning of sample lines, changing of reagents and annual servicing.

Service schedule

Period	Schedule
12 monthly	Replace piston assembly and sample tubing.
24 monthly	Replace valve diaphragms, piston assembly and monitor tubing.

All parts are provided in convenient maintenance kits.

Solution replacement

The Aztec 600 Ammonia analyzer uses a total of approximately 25 ml of sample, per analysis: 7.5 ml for the actual measurement and the remainder for cell rinsing. The automatic 2-point calibration substitutes the sample with the calibration solutions at the same amount.

Above 0.5 ppm NH₃ the Aztec 600 Ammonia dilutes samples automatically with de-ionised water, to maximize the measurement range. The dilution ratio between sample and de-ionised water is user-configurable between: 1:1, 1:2, 1:3, 1:4.

Dilution ratio	Approximate volume of de-ionised water used per measurement
1:0	0 ml
1:1	12.5 ml
1:2	16.5 ml
1:3	19 ml
1:4	20 ml

A standard set of reagents consists of three reagents (5 litres of each) and a high standard (2.5 l). The reagent usage depends on how many samples per hour are being measured.

Samples per hour	Duration of reagent set (days)
6	40
4	60
3	80
2	120
1	240

Flexible communications

Ethernet-ready

The Aztec 600 provides 10BaseT Ethernet communications via a standard RJ45 connector and uses industry-standard protocols TCP/IP, FTP and HTTP. The use of standard protocols enables easy connection into existing PC networks.

Data file access via FTP (File Transfer Protocol)

The Aztec 600 features FTP server functionality. The FTP server in the analyzer is used to access its file system from a remote station on a network. This requires an FTP client on the host PC. Both MS-DOS® and Microsoft® Explorer version 5.5 or later can be used as an FTP client.

- Using a standard web-browser or other FTP client, data files contained within the analyzer's memory or memory card can be accessed remotely and transferred to a PC or network drive.
- Four individual FTP users' names and passwords can be programmed into the Aztec 600. An access level can be configured for each user.
- All FTP log-on activity is recorded in the audit log of the analyzer.
- Using ABB's data file transfer scheduler program, data files from multiple analyzers can be backed-up automatically to a PC or network drive for long-term storage, ensuring the security of valuable process data and minimizing the operator intervention required.

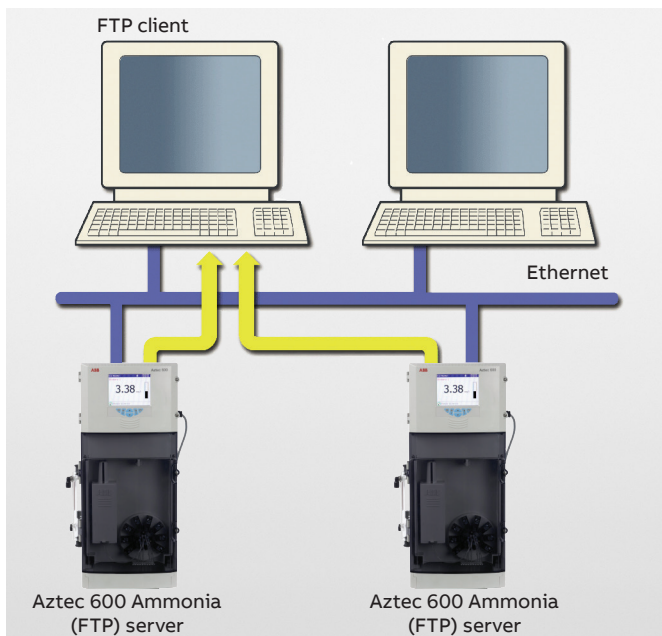

Embedded web server

The Aztec 600 Ammonia has an embedded web-server that provides access to web pages created within the analyzer. The use of HTTP (Hypertext Transfer Protocol) enables standard web browsers to view these pages.

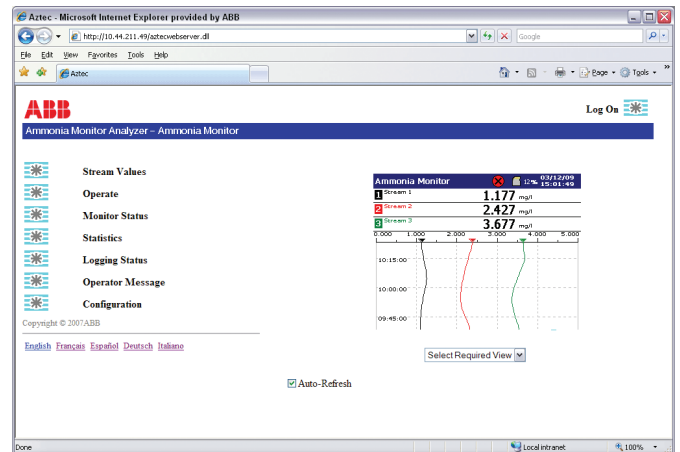

- Accessible through the web pages are the current display of the analyzer, detailed information on stream values, reagent and solution levels, measurement status and other key information.
- The audit and alarm logs stored in the analyzer's internal buffer memory can be viewed on the web pages.
- Operator messages can be entered via the web server, enabling comments to be logged to the analyzer.
- The web pages and the information they contain are refreshed regularly, enabling them to be used as a supervision tool.
- The analyzer's configuration can be selected from an existing configuration in the internal memory or a new configuration file transferred to the analyzer via FTP.
- The analyzer's real-time clock can be set via the web server. Alternatively, the clocks of multiple analyzers can be synchronized using ABB's File Transfer Scheduler software.

E-mail notification

Via the Aztec 600 Ammonia's built-in SMTP client, the analyzer is able to e-mail notification of important events. E-mails triggered from alarms or other critical events can be sent to multiple recipients. The analyzer can also be programmed to email reports of the current measurement status or other parameters at specific times during the day.

Profibus

The Aztec 600 Ammonia can be equipped with Profibus DP V1.0 to enable full communications and control integration with distributed control systems.

Specification

Measurement range

Ammonia

Auto-ranging	0 to 3.000 ppm NH ₃
Undiluted range	0 to 0.500 ppm NH ₃
Diluted range	0.5 to 3.000 ppm NH ₃

Chemical method

Ammonia

Indophenol blue

Background color correction

Compensated at the measurement wavelength

Self-cleaning

Programmable automatic chemical rinsing – piston cleaned every measurement

Measurement mode

Batch measurement

User-selectable 1 to 4 measurements per hour

Sample streams

Single or up to 3 streams – sequencing is programmable

Measurement performance

Accuracy¹

<±5 % of reading² or ±0.005 ppm
(whichever is the greater)

Repeatability

<±5 % of reading³ or ±0.005 ppm
(whichever is the greater)

Resolution

0.001 ppm or 1 ppb

Measurement units

mg/l, ppm, ppb, µg/l

Calibration

2-point, automatic calibration, with the option of manual initiation. The interval between automatic calibrations manually selectable from four times a day to once per week.

Environmental data

Ambient operating temperature

5 to 45 °C (41 to 113 °F)

Ambient operating humidity

Up to 95 % RH non-condensing

Sample temperature

1 to 40 °C (32 to 104 °F)

Sample flow

Continuous, 200 to 500 ml/min

Sample pressure

5 psi maximum

Sample limitations

Samples containing particles 100 microns (0.004 in.) in diameter or larger may require pre-filtration.

Maintenance

Routine service interval

12 months

Reagent consumption

0.75 ml of each reagent per measurement

Display

- Color, TFT, liquid crystal display (LCD) with built-in backlight and brightness adjustment
- Diagonal display area 145 mm (5.7 in.)
- 76800 pixel display*

* A small percentage of the display pixels may be either constantly active or inactive. Max. percentage of inoperative pixels <0.01 %.

Dedicated operator keys

- Group select / left cursor
- View select / right cursor
- Menu key
- Up / Increment key
- Down / Decrement key
- Enter key

¹ Maximum measured error across full measurement range.

² Tested in accordance with IEC 61298 Parts 1-4 : Edition 2.0 2008-10.

³ Tested in accordance with BS ISO 15839 : 2003.

Mechanical data

Ingress protection

IP31**

Sample connections

Inlet: 6 mm OD push-fit x ¼ in. BSP elbow
 Outlet: 10 mm OD push-fit x 3/8 in. BSP elbow

Dimensions

Height 653 mm (25.7 in.)
 Width 366 mm (14.4 in.) max.
 Depth 183 mm (7.2 in.) door closed
 430 mm (16.9 in.) door open
 Weight 15 kg (33 lb)

Materials of construction

Electronics enclosure 10 % glass loaded polycarbonate
 Main enclosure Noryl
 Lower tray 20 % glass loaded polypropylene
 Door Acrylic

Electrical

Power supply ranges

- 100 to 240 V max. AC, 50 / 60 Hz ± 10 %
 (90 to 264 V AC, 45 / 65 Hz)
- 18 to 36 V DC (optional)

Power consumption

75 W max. – AC
 100 W max. – DC

Analog outputs

Single and multi-stream analyzers

6 isolated current outputs, fully assignable and programmable over a 0 to 20 mA range (up to 22 mA if required)

Alarms / Relay outputs

Single- and multi-stream analyzers

One per unit:

- Stop relay
- Attention relay
- Failure relay
- Calibrate relay

Six per unit:

- Fully user-assignable alarm relays

Rating

Voltage	250 V AC	30 V DC
Current	5 A AC	5 A DC
Loading (non-inductive)	1250 VA	150 W

Connectivity / Communications

Ethernet connection

Web server with FTP – for real-time monitoring, configuration, data file access and email capability

Communications

Profibus DP V1.0 (optional)

Data handling, storage and display

Security

Multi level security Operator and configuration password or security switch

Storage

Removable Secure Digital (SD) card

Trend analysis

Local and remote

Data transfer

SD card or FTP

Approvals, certification and safety

Safety approval

cULus

CE Mark

Covers EMC & LV Directives (including latest version EN 61010)

General safety

- EN61010-1
- Overvoltage Class II on inputs and outputs
- Pollution category 2

EMC

Emissions & immunity

Meets requirements of IEC61326 for an industrial environment

Overall dimensions

Dimensions in mm (in.)

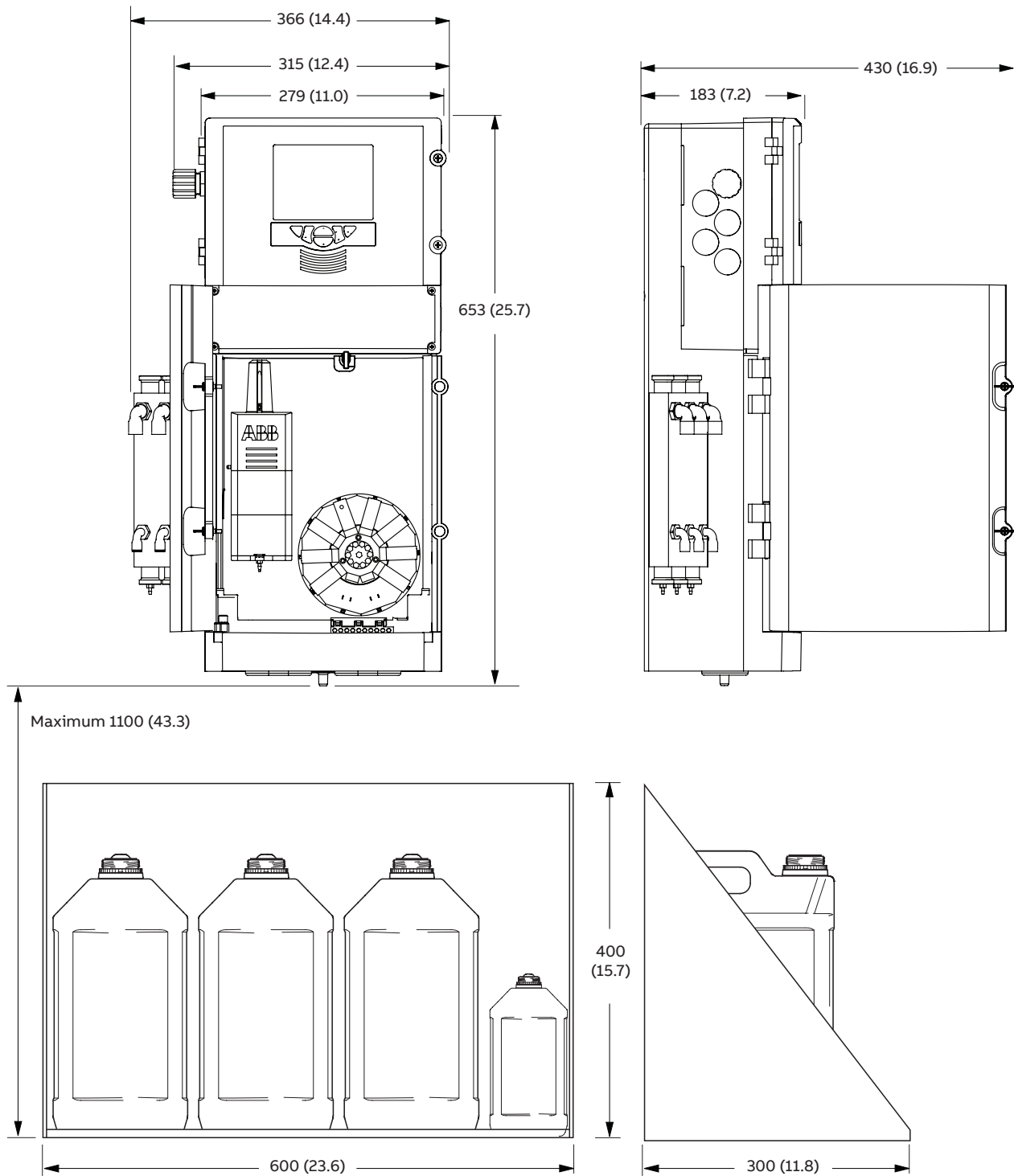

Overall dimensions of Aztec 600 analyzer and optional reagent support tray

Ordering information

Aztec 600 Ammonia analyzer	AW632	X	X	X	X	X	0	X	X
Range									
0 to 3.000 ppm NH ₃	5								
Number of streams									
Measuring 1 stream			1						
Measuring 1 stream with additional valve for cleaning			2						
Measuring 3 streams			3						
Communications									
None						0			
Profibus DP V1.0						1			
Enclosure									
Standard							0		
Power supply									
90 to 264 V AC / 50 to 60 Hz								0	
18 to 36 V DC								1	
Reserved									0
Manual									
English									1
French									2
Italian									3
German									4
Spanish									5
Certification									
None									0
Certificate of calibration									1

Accessories

Reagent support tray (stainless steel) – part no. 03-0051-A

Acknowledgements and trademarks

Windows, Microsoft, MS-DOS and Internet Explorer are registered trademarks of Microsoft Corporation in the United States and/or other countries.

Profibus® is a registered trademark of Profibus International.

Sales



Service



Software



Notes

ABB Limited**Measurement & Analytics**

Oldends Lane, Stonehouse
Gloucestershire, GL10 3TA
UK

Tel: +44 (0)1453 826 661

Fax: +44 (0)1453 829 671

ABB Inc.**Measurement & Analytics**

125 E. County Line Road
Warminster, PA 18974

USA

Tel: +1 215 674 6000

Fax: +1 215 674 7183

abb.com/measurement

We reserve the right to make technical changes or modify the contents of this document without prior notice. With regard to purchase orders, the agreed particulars shall prevail. ABB does not accept any responsibility whatsoever for potential errors or possible lack of information in this document.

We reserve all rights in this document and in the subject matter and illustrations contained therein. Any reproduction, disclosure to third parties or utilization of its contents – in whole or in parts – is forbidden without prior written consent of ABB.